

# A compact smart camera that simplifies inspections



# Simplify multiple-device inspection systems by using a single camera

Traditional image inspections require one or more dedicated cameras to be paired with a code reader. Omron's F430-F/F420-F Series Smart Camera bundles all this functionality into a single device, dramatically simplifying application design. The single-camera solution also reduces the initial investment, cuts down on wiring work and keeps maintenance costs to a minimum.

## Inspections | 01

Multiple cameras in one to enhance precision

## Inspections | 02

A single camera performing powerful inspection tasks and code reading

## Inspections | 03

A single camera designed for long operational lifetime

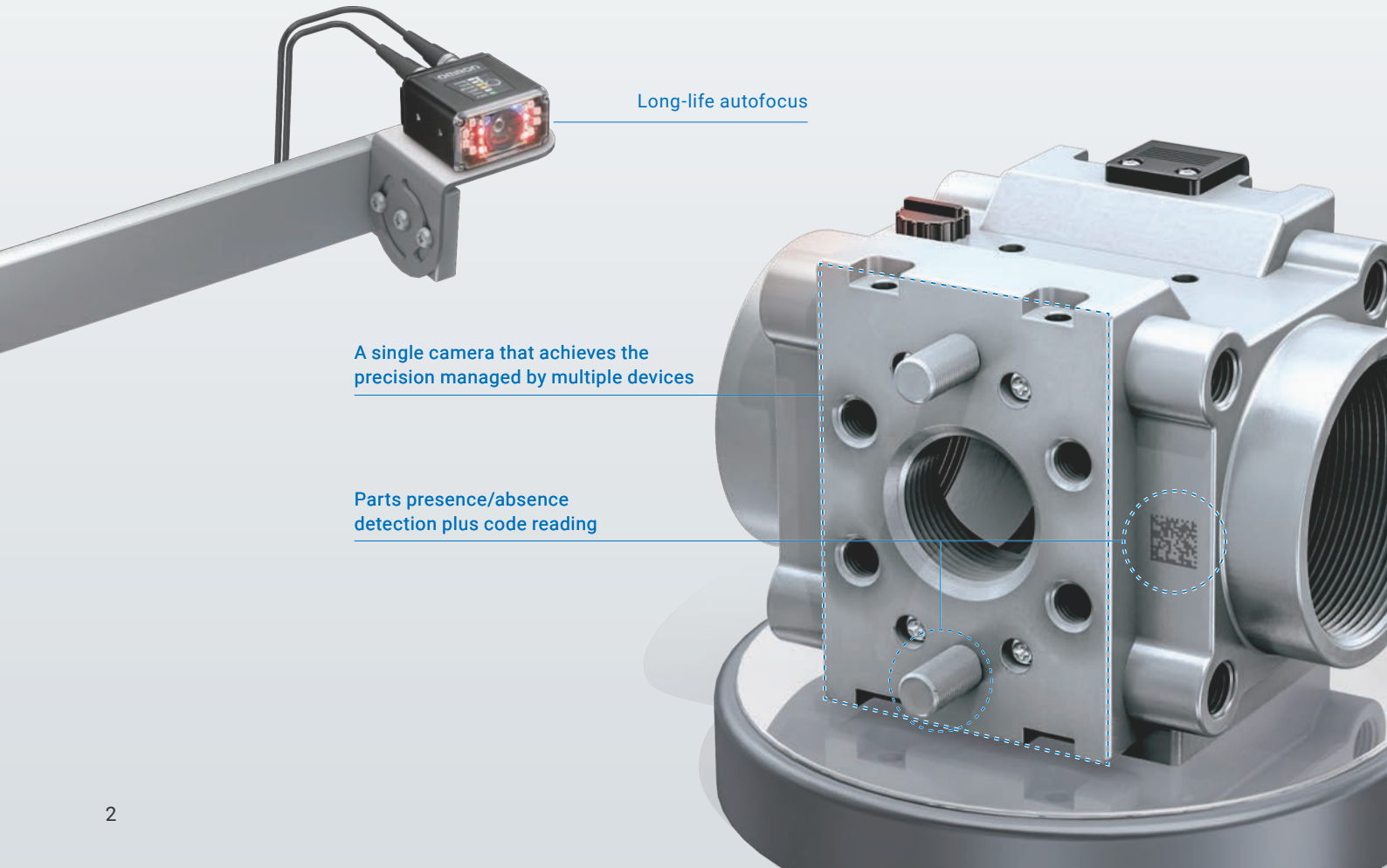

## Inspections | 01

### Multiple cameras in one to enhance precision

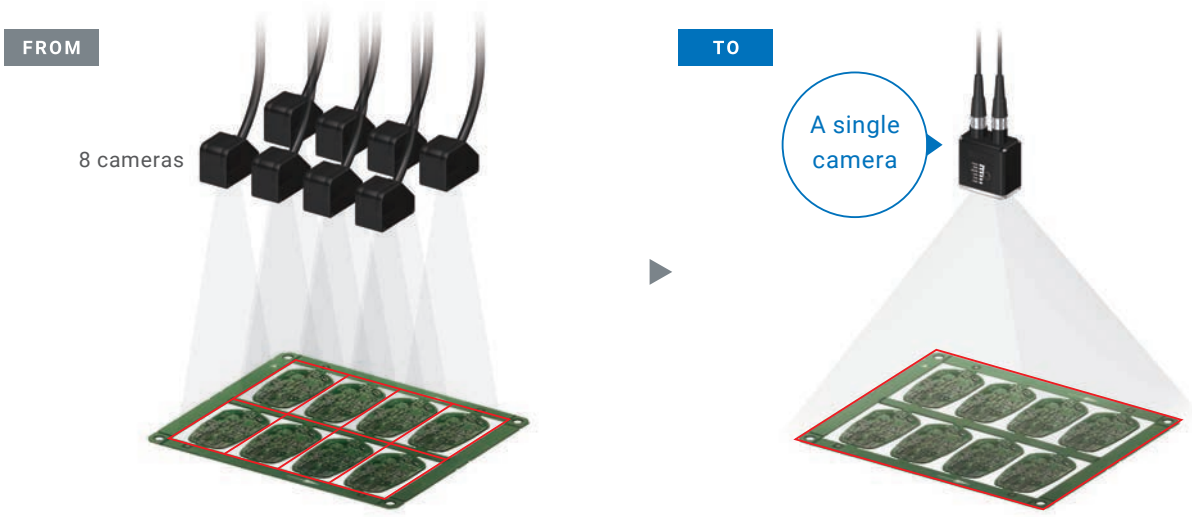

Mechanical design is required for multiple cameras. Positioning of the mechanism and fine-tuning of software are time consuming.

Only a single camera is required, simplifying design and fine-tuning.

When using low-resolution cameras, multiple cameras are needed to divide a view in several sections and achieve the resolution required for inspections. The 5-megapixel color camera of the F430-F/F420-F Series delivers high-resolution imaging of multiple points with a single device.

#### Inspection scope examples

0.3 Megapixel color camera: 1 PCB



5 Megapixel color camera: 8 PCBs



### Positioning of a single camera only

A single camera can capture a wide view, eliminating the need to combine multiple cameras that require time-consuming positioning design and fine-tuning.

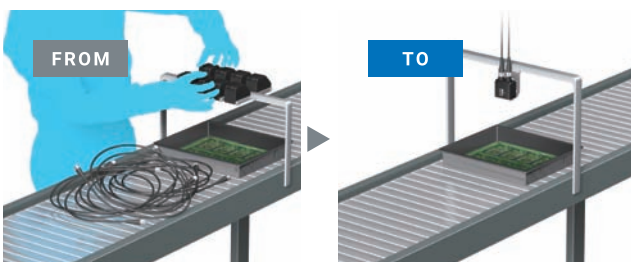

### Presence, color and shape detection and reading at the same time

The F430-F/F420-F Series can simultaneously perform detection tasks (presence, color, and shape) and code reading within the field of view. You can easily increase inspection points for quality enhancement.

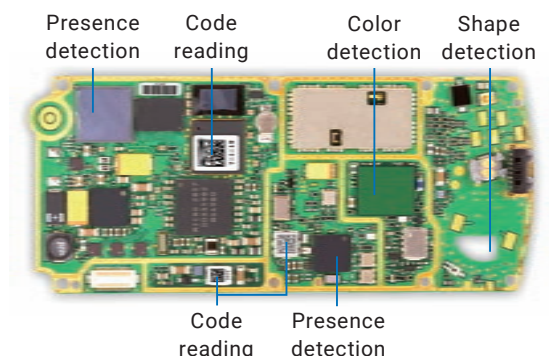

## Inspections | 02

### A single camera performing powerful inspection tasks and code reading

FROM

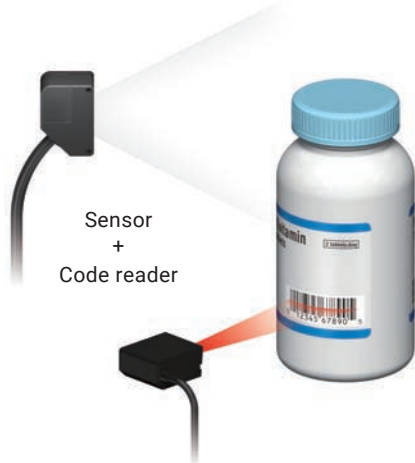

Installation space and communication design are required for both the sensor and code reader.

TO



Installation space and communication design are required for a single smart camera only.

To perform a simple inspection task - such as presence/absence detection, color detection, etc. - along with a code or character reading, a highly-functional sensor or a sensor combined with a code reader for each purpose would be required. The F430-F/F420-F Series successfully performs both functions, simplifying inspection tasks overall.

Code reading



Cap presence/absence inspection

Cap present **OK**    Cap absent **NG**



### Wiring and installation space reduced by half

A single camera with smart camera and code reader functionalities halves the number of cables to the host device and the installation space.

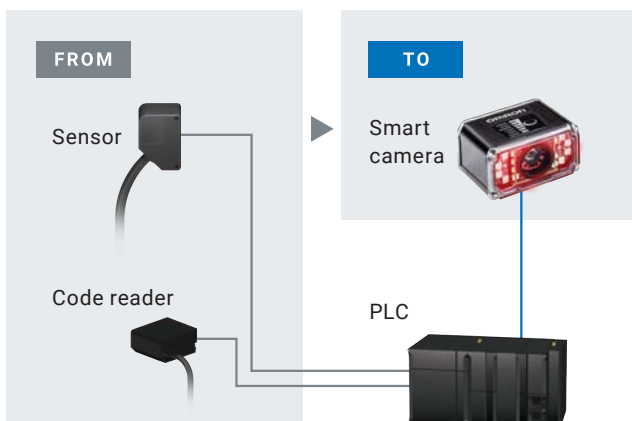

### Text and verification result output

The F430-F/F420-F Series can output character strings and code quality verification results, which is difficult with standard smart cameras. The output information can be used for traceability.

#### Example of output data

1. Result of inspection: OK/NG
2. Result of code reading: Character string
3. Result of verification: Quality grade of code

# The long-life autofocus lens provides long operational lifetime without the need for replacement

How long until the camera is replaced due to failure caused by focus changes?

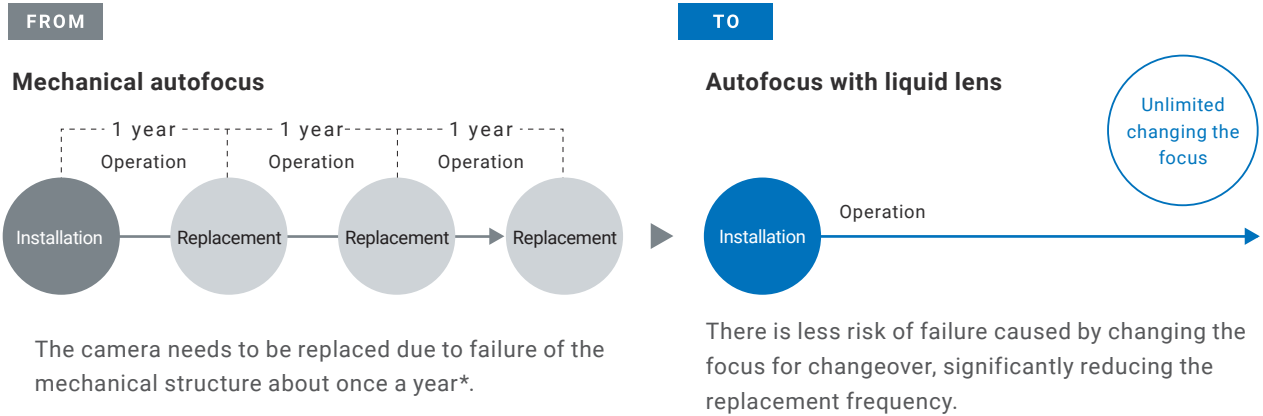

The F430-F/F420-F Series with a long-life liquid lens provides unlimited autofocus, easily focusing on different items just by switching the focus. The liquid lens greatly reduces the replacement frequency that is once every several months to several years with the mechanical autofocus lens.

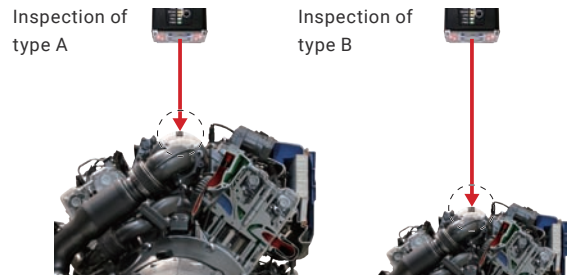

## Difference between mechanical autofocus and liquid lens autofocus

Mechanical autofocus uses a small motor as a major component. Metal fatigue and wear shorten the life of the camera, which requires replacement every year. The liquid autofocus lens can flexibly change its focal length without mechanical wear by applying voltage to change the internal oil and water shape.

### Mechanical autofocus

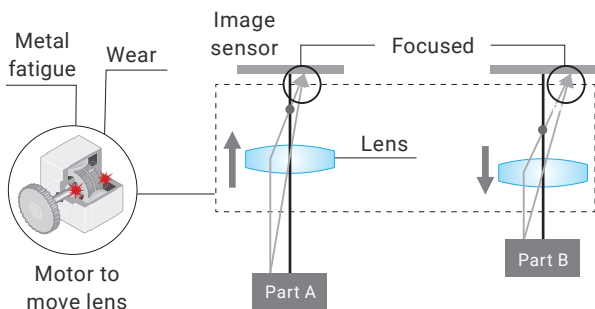

### Autofocus with liquid lens

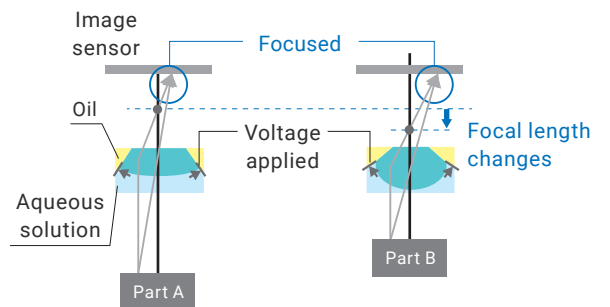

\* Calculated using Omron's condition below.

Limit of standard mechanical autofocus : 50,000 operations

Usage condition: Focus is changed 200 times a day for 20 days a month. 200 operations x 20 days x 12 months = 48,000 operations » approximately 1 year.

# Tools

12 tools are provided.

The provided tools vary depending on the model. Refer to the datasheet for details.



Count

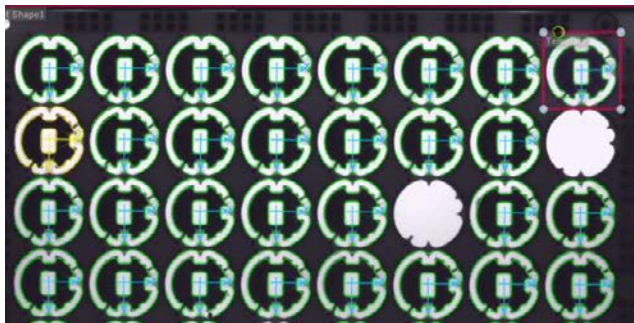

Counts objects detected within the inspection area.  
(Method: Select from Blob Count and Shape Count)



Measure

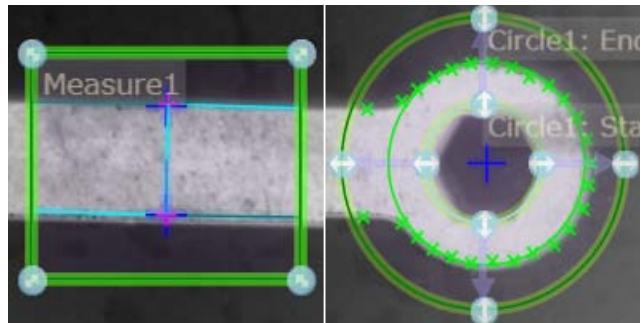

Measures width or height between two edges.  
(Method: Select from Width Measure, Height Measure, Circle Measure, Point to Point Measure, Point to Line Measure, and Angle Measure)



Presence/Absence

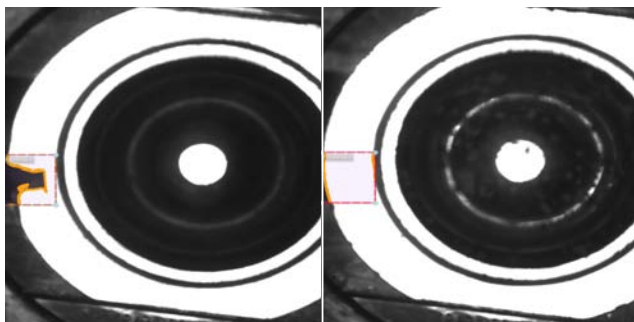

Inspects the presence of objects.  
(Method: Select from Count Gray Pixels and Count Edge Pixels)



Color (5 Mpix camera)



Judges whether the color matches the registered one.  
The degree of match can be adjusted in percent. Speed can be increased by setting the precision parameter.



Decode



Reads a bar code or 2D code. The Match String function allows this smart camera to perform verification that is usually done by a PC or PLC.



Symbol Quality Verification

Parameter Grades:			Calibration Data:	
	Grade	Score	Units	
Symbol Contrast	A	100	%	State: Not Calibrated
Modulation	A			Target Symbol 1 Width: 0.24
Reflectance Margin	A			Target Symbol 2 Width: 0.48
Fixed Pattern Dmg	A			Maximum Exposure: 32000
Axial NonUniformity	A	0	%	Target Rmin: 4
Grid NonUniformity	A	8	%	Target Rmax: 82
Unused Err Correction	A	100	%	

Enables simple print quality verification of codes to application standards such as ISO 15415, AIM DPM/ISO 29158, and ISO 15416. Also automatically generates reports.  
Note: QR codes cannot be verified. The Calibration Card is required.



OCR

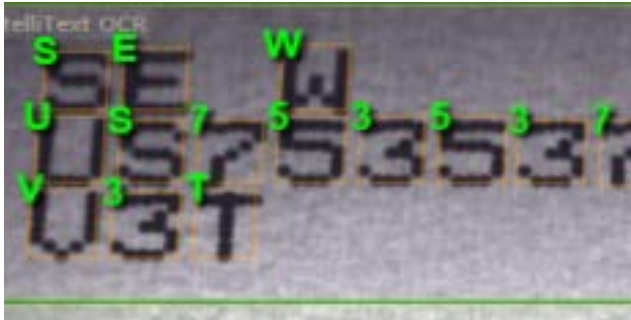

Just draw a square around characters to read them using its built-in dictionary. Reads capital alphabets, numbers, and multi-row text and compares them with the character string received from the host device.



Locate



Outputs the position and angle of the registered image. The inspection area of this tool can automatically be used for the processing following this tool.



Match Strings Tool



Compares a human-readable character string read by OCR with data contained in the code read by CR, which is mostly done by a PC or PLC.



OCV

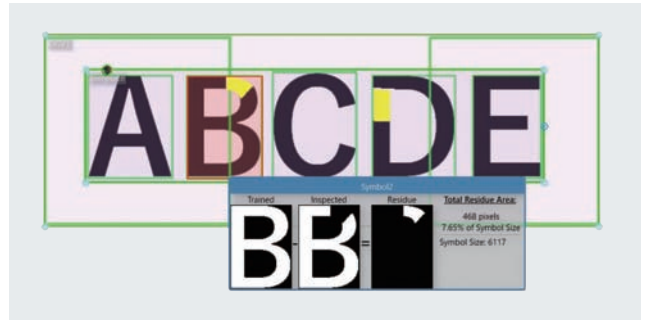

Detects defects from measured character strings using the registered reference character string. Automatically focuses on a target character string even if its position differs.

\* Up to ±15°



String Format

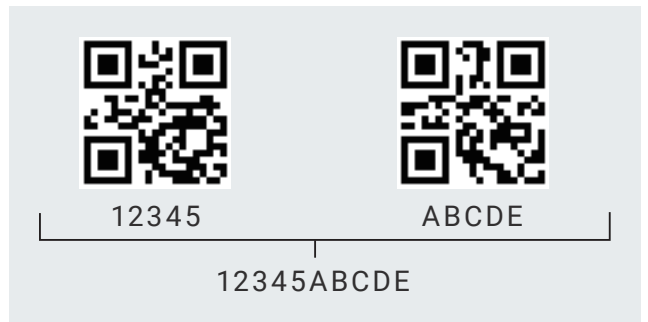

Outputs extracted character strings and combined two character strings, which is usually done by a PC or PLC.



Logic Tool

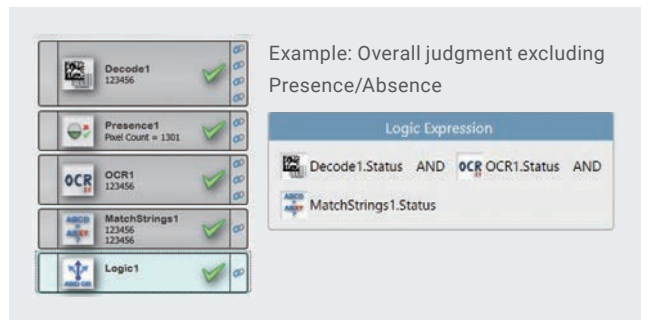

Performs logical operation and compares sizes of tool results. Logical operation of "status" of each tool can be used to create individual judgment conditions instead of the overall condition.

# Simple setup on a single screen AutoVISION Software

## 3-step easy setting

Follow the guide on the screen to start inspection in three steps: Image, Edit, and Run.

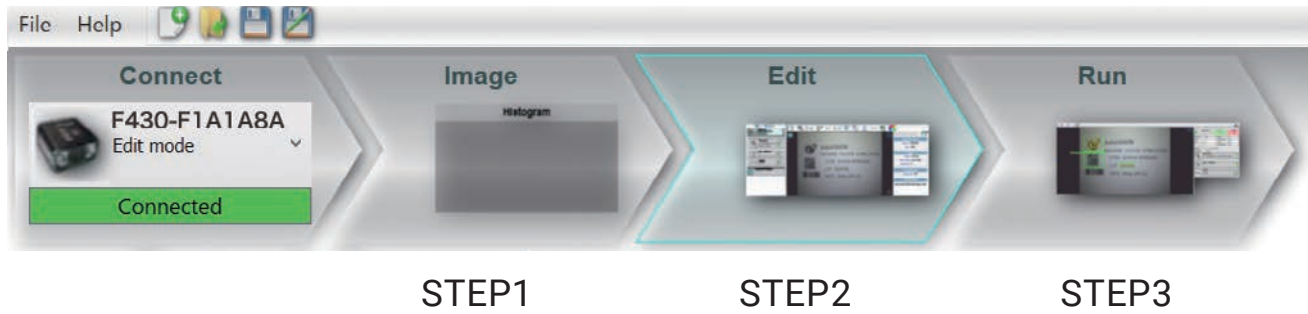

### STEP 1. Image One click to optimize image

Place an object within a focal length and press the Autofocus button to optimize the focus and brightness of the inspection image.

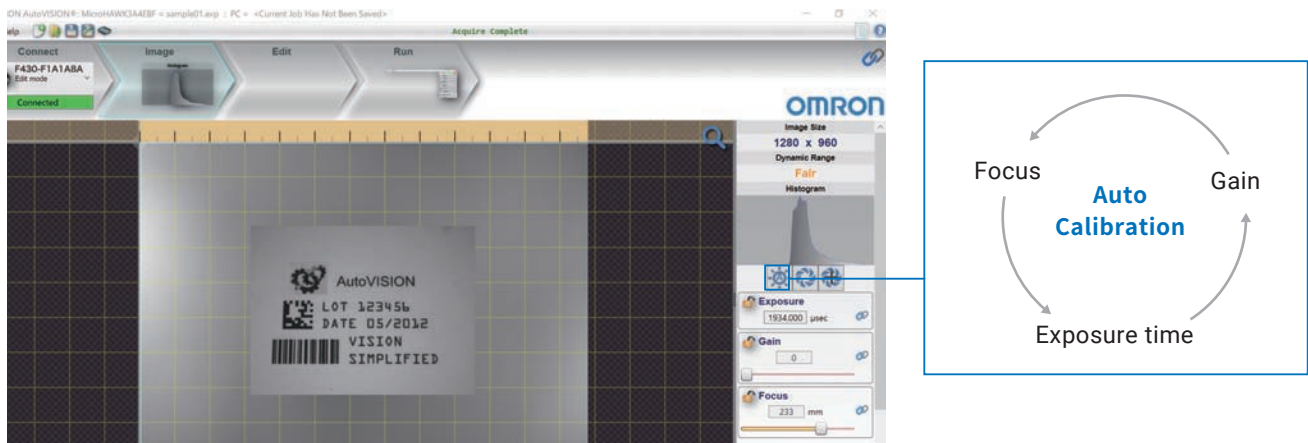

### STEP 2. Edit Just select tools and specify inspection areas

Setup can be done by simply selecting tools and specifying the inspection areas. You can check the test measurement results on this screen and adjust the inspection range and the threshold by viewing the screen.

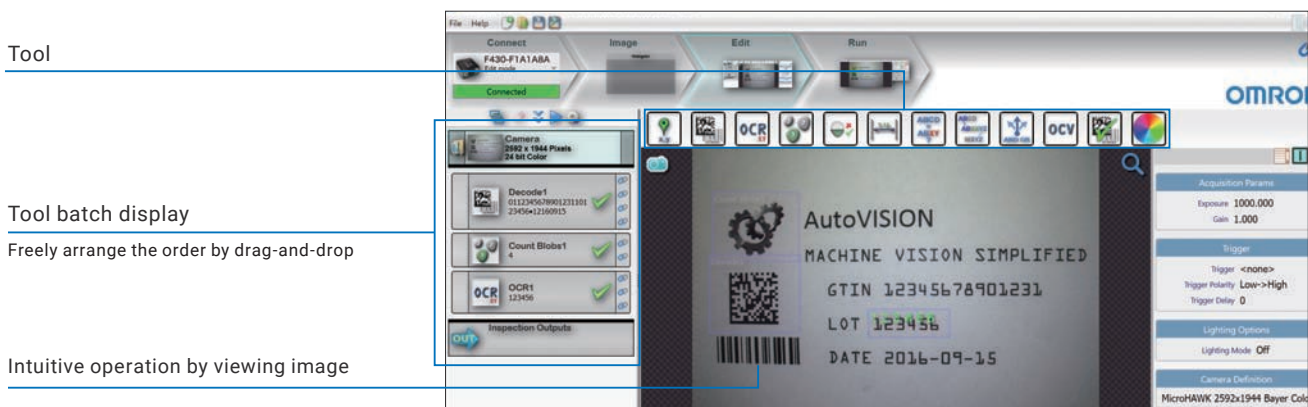



## STEP 2. Edit Allocate outputs

Select values and memory areas for each tool to allocate outputs, reducing PLC connection design time. In addition to OK/NG results, measured values, code reading results, and OCR results can be output, which is useful for data collection.

Example: Output of OCR results

Data that can be output is displayed as selections. Example: OCR

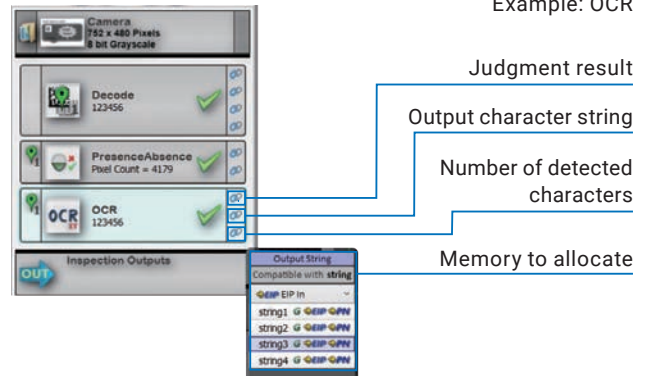

## STEP 3. Run One click to start inspection

Just press the Run button to start the inspection. Inspection results are displayed on the screen in real time.

### Utilization

## Free software and materials available to support your learning

AutoVISION software is available for free. Visit your local omron website or ask to your omron representatives.

The quick start guide and sample image/job data attached with the software will help you use the software. The software includes the help file, allowing you to refer to help without connecting to a network.

## Examples of materials and data to support your learning

### Quick start guide



A quick guide showing how to start inspection is attached.

### Help file

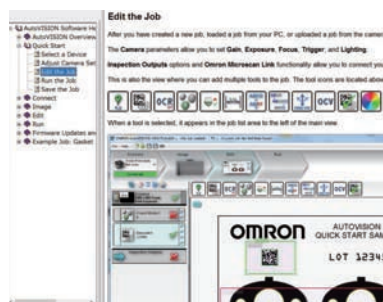

The help file can be easily opened from the help menu in AutoVISION. Offline help can be used without connecting to a network.

### Sample image/job data



It contains sample images and job data that will be helpful for learning how to operate.

# Easy-to-see display of inspection status

## WebMonitor Software

### Improve usability with large display

Your tablet or PC with a web browser can be used as the display, providing much better visibility than small displays of standard smart cameras. Choose a device size to suit the installation environment and inspection images. Refer to the datasheet for browser requirements.

#### Standard smart cameras

The small dedicated display provides limited visibility.



Up to 6 inches

#### F430-F/F420-F Series

A large, high-resolution display can be used.

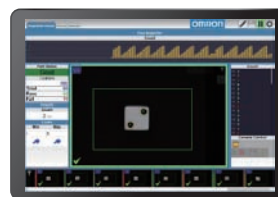

Selectable size

### Customizable user interface to maximize usability of large screens

The WebMonitor software facilitates customization of the user interface. Simply select from various pre-installed widgets and place the widget. No programming is required.

#### Example of widget layout

**Inspection Counters**  
Shows measurement, pass, and fail counts.

**Read Value**  
Shows a parameter and the measured value.

**Write Value**  
Allows you to modify a parameter.

**Image Filmstrip**  
Shows a history of measurement images. Pass or fail inspection images can be displayed.

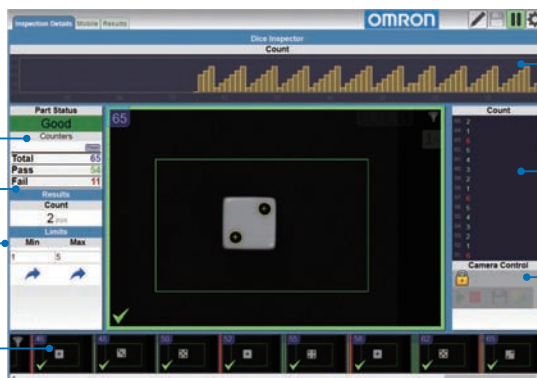

**Chart**  
Shows a chart of measured values.

**Log of Values**  
Shows measured values as a historical list.

**Device Control**  
Allows you to start and stop measurements, and to change and save job data.

Note: The ability to display 100% of inspection images depends on the number of inspection tasks, line speed, and the number of connected cameras.

#### Example: Displaying decoded code

**STEP 1** Link a parameter

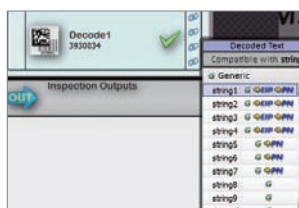

Assign the position and angle data of the Locate tool to memory in the AutoVISION software.

**STEP 2** Place a widget

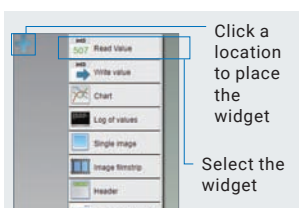

Place a widget in the WebMonitor.

**STEP 3** Select the parameter

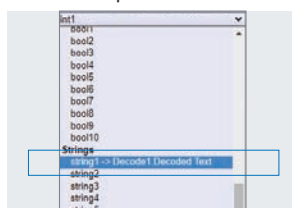

Select the parameter to display in the WebMonitor.

Decoded Text  
3930034

The selected parameter is displayed.

# Reduce equipment costs by integrating monitoring of multiple cameras

Inspection status of multiple cameras can be monitored using a single device. Unlike standard smart cameras which require a display for each camera, the F430-F/F420-F Series requires only one display for all cameras, reducing not only initial and installation costs but also time to view each display.

## Standard smart cameras

One display per camera

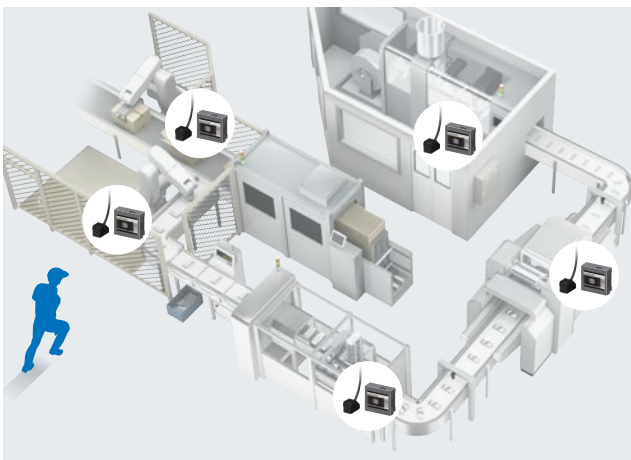

## F430-F/F420-F Series

One display for all cameras

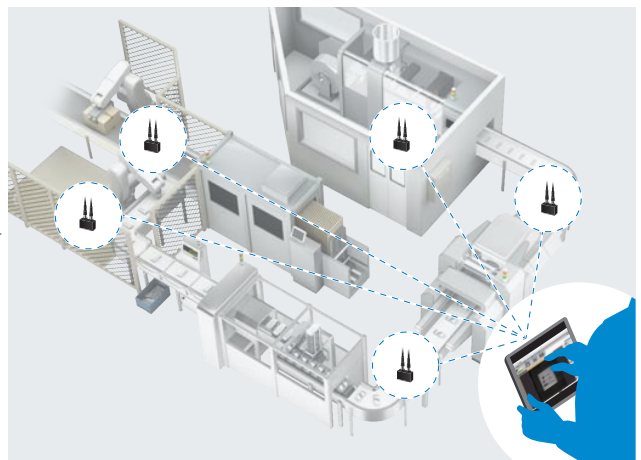

Note: The maximum number of cameras that can be simultaneously monitored on the WebMonitor varies depending on the inspection cycle time and system environment.

## Web browser interface for easy integration of monitoring

The WebMonitor software pre-installed in the smart camera allows you to view inspection status simply by connecting your tablet or PC that has a web browser. When multiple smart cameras are monitored, the smart camera to display can be easily changed by entering its IP address in your web browser.

### Configuration example

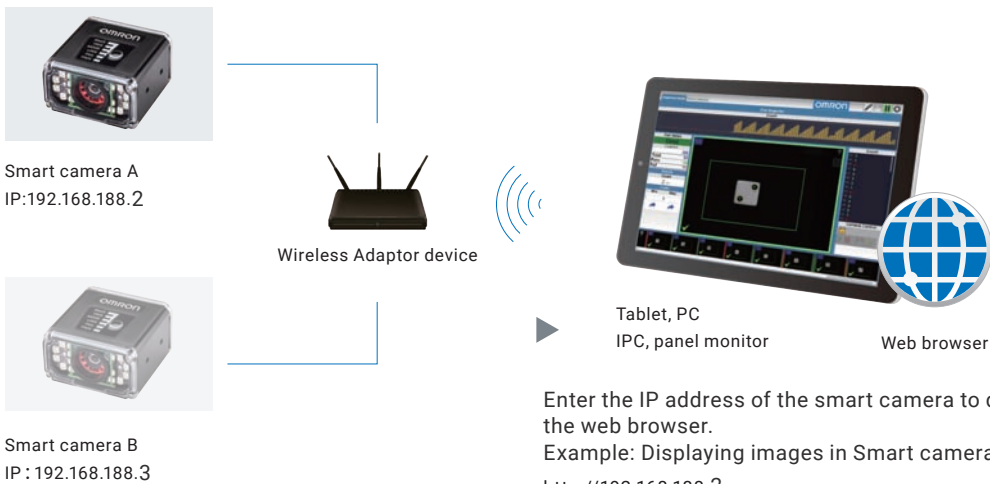

# Attachments to capture clear images

## Eliminate uneven lighting and halation

### Polarizer and Diffuser

Attaching a polarizer or diffuser reduces halation and reflection without the need to install the camera at an angle.

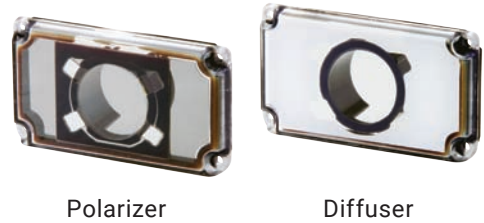

### Polarizer

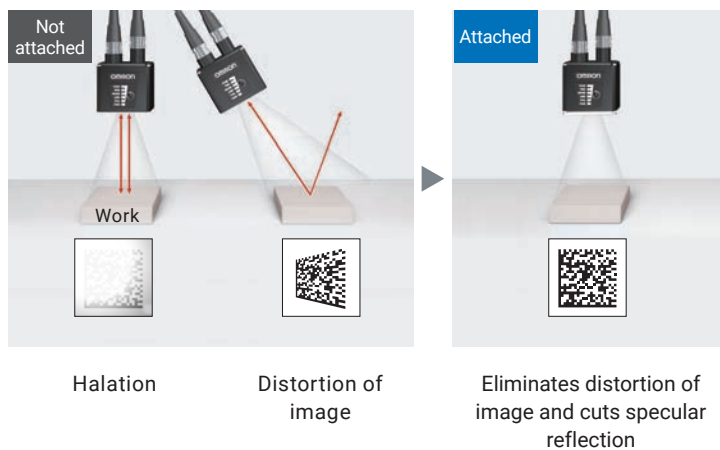

### Diffuser

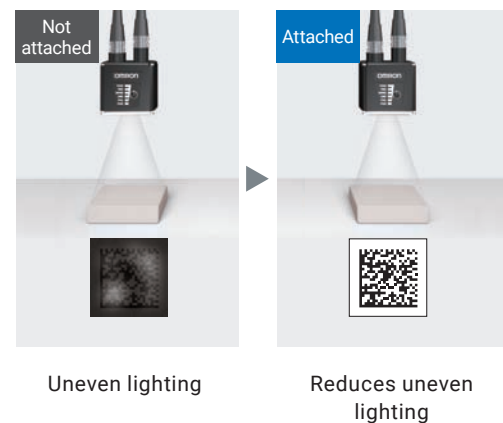

## Protect against laser radiation

### YAG Filter

When the smart camera is installed near YAG laser equipment (e.g., laser marker, laser engraver, and laser cutter), the YAG filter is used to protect image elements against laser light.



## Protect against static

### ESD Safe Window\*

To prevent line or object problems caused by electrostatic discharge (ESD) of the smart camera, the ESD safe window is used.

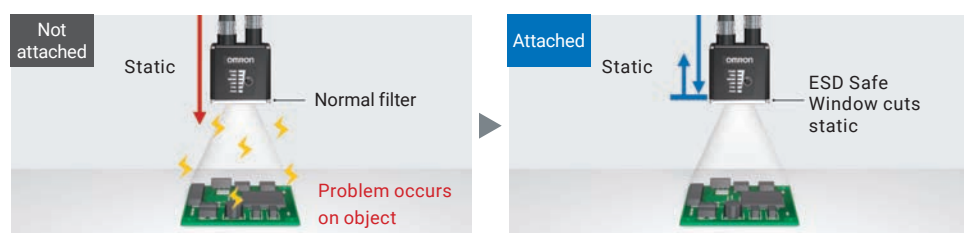

\* This model is coming soon.

## Install in a confined space

### Right Angle Mirror

The right angle mirror is used to install the smart camera in a space where the camera cannot face the object.

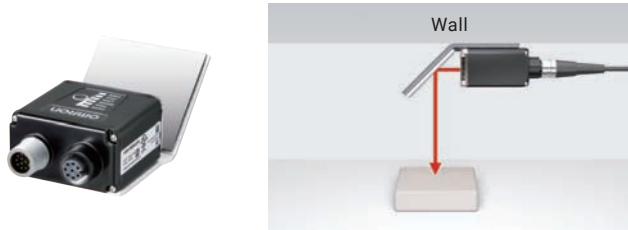

### Right Angle Connector

This connector can be used when there is no wiring space behind the smart camera.



(Right angle down (photo above) and right angle up connectors are available.)

## Use under insufficient light

### Ring Light Model

This model can provide reliable inspection even under insufficient light conditions and maintain the shutter speed to focus on high-speed lines, which both are difficult with a standard light.

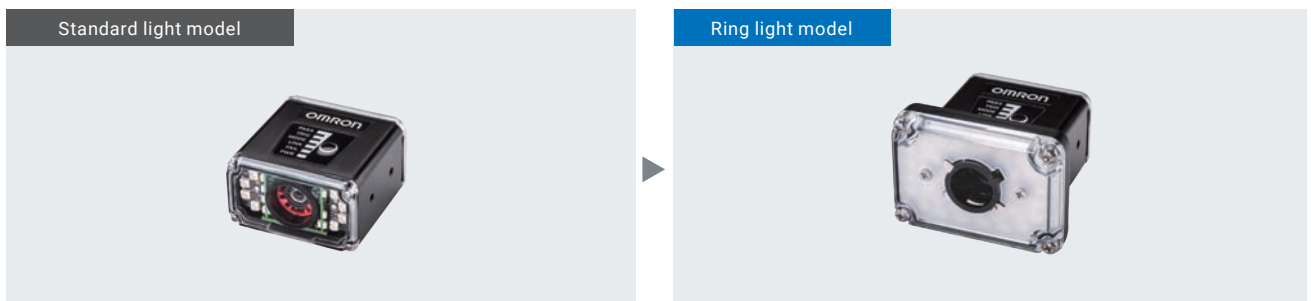

The ring light model is available with F430 1.2 Mpix Cameras.

## Enhance contrast

### Color Filters

The color filter is used with a monochrome camera with white light when you want to emphasize the area where the intensity of the red or blue component is high.



Inspection area

With Red Filter

With Blue Filter

### Additional Lighting Options

This option is used with a monochrome camera when you want to emphasize a specific color component or infrared ink. White, red, blue, and IR LEDs are available.

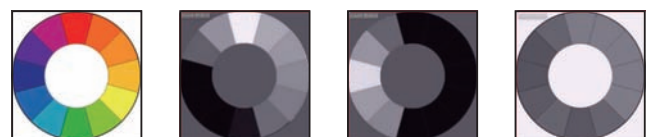

Color Camera  
White LEDs

Mono Camera  
Red LEDs

Mono Camera  
Blue LEDs

Mono Camera  
IR LEDs

# Applications

## Automotive industry

Incorrect gear inspection

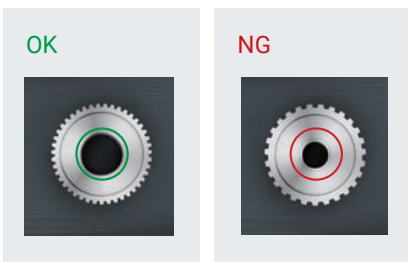
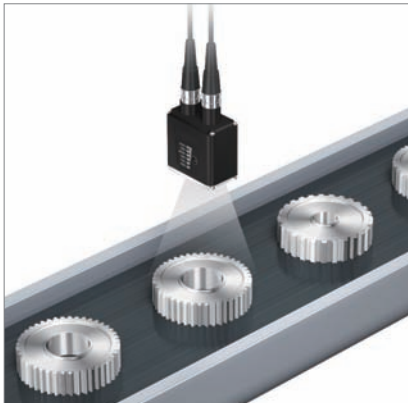

Orientation inspection of attached rubber

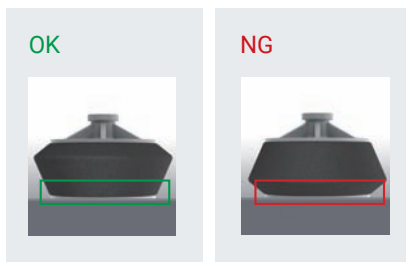

Reading lot numbers and codes on automotive body parts

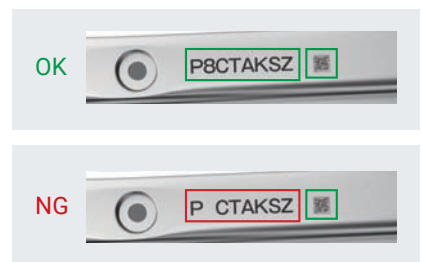
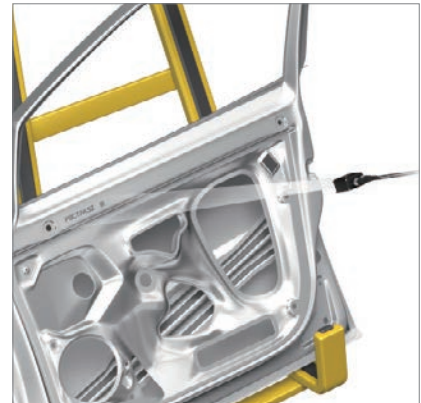

## Digital industry

Presence inspection and code reading of electronic components

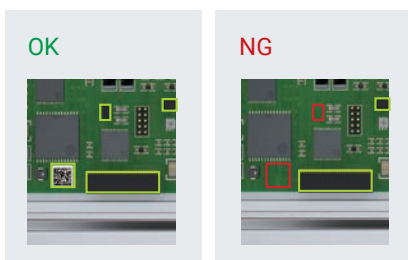
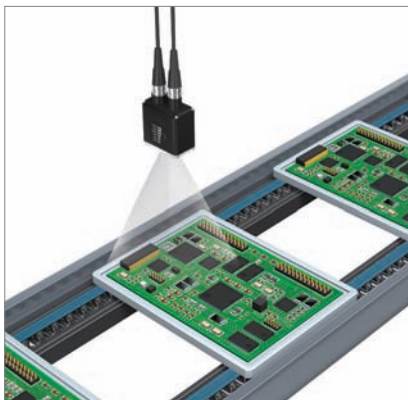

Presence inspection of PCB mounted components

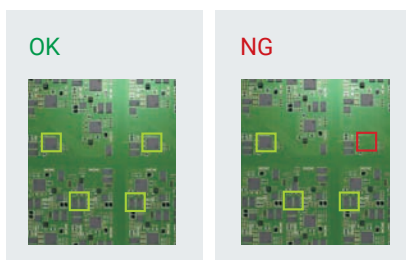
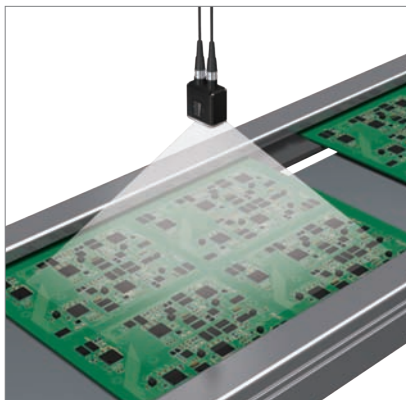

Identification of electronic components

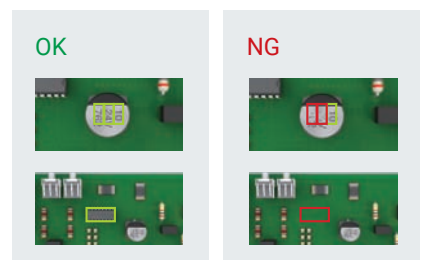
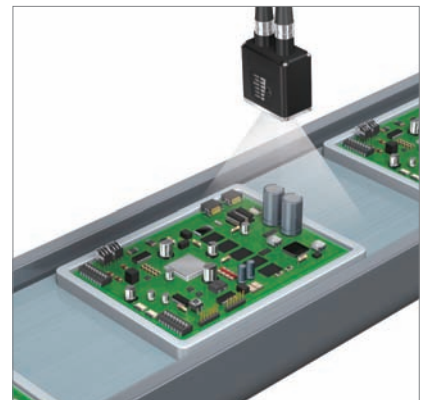

# Food, beverage, and pharmaceutical industry

Label presence inspection

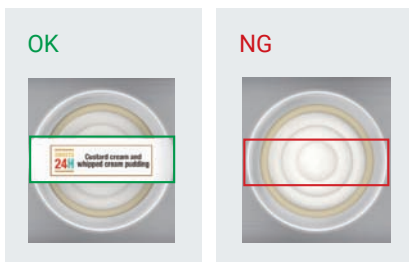

Inspection for absence of medicines in blister packs

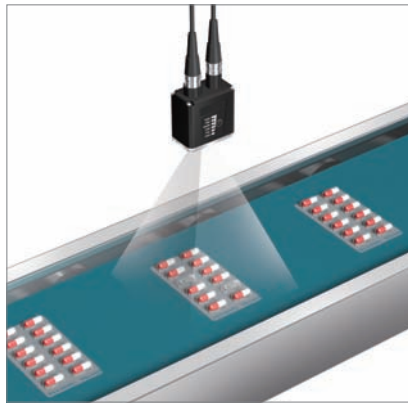

Capping and label presence inspection of beverage bottles

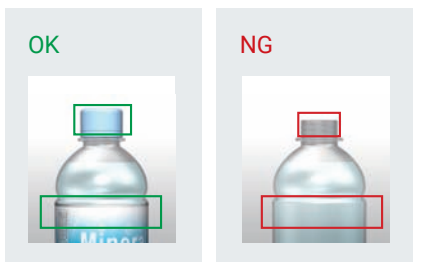

# Logistics industry

Label orientation inspection, and code and expiration date inspection



Product quantity inspection

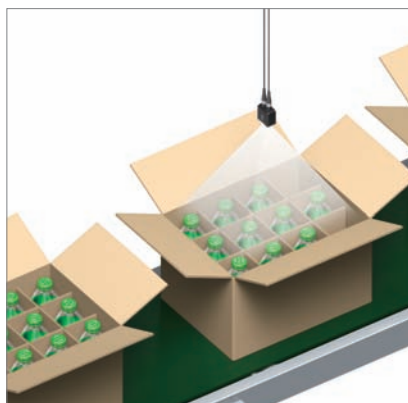

Code print quality verification of packing boxes

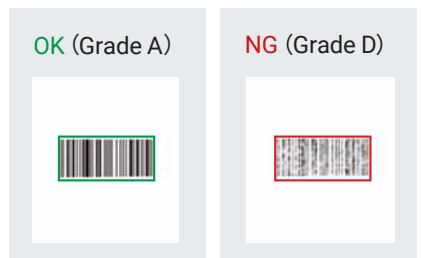
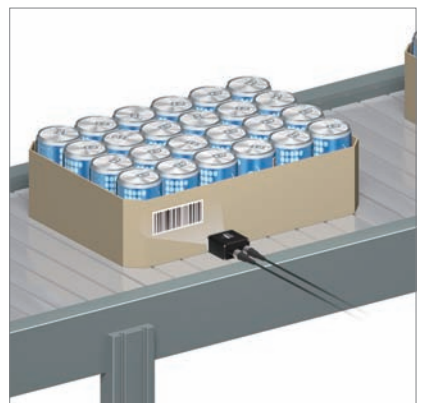

Take advantage of the F430-F/F420-F Series to perform a variety of inspection tasks with less time and effort

Choices with different I/O interfaces

- RS-232C
- Ethernet TCP/IP
- EtherNet/IP™
- PROFINET

F430-F Series  
(Catalog No.Q278)



- RS-232C
- USB
- Ethernet over USB

F420-F Series  
(Catalog No.Q279)



## F330-F/F320-F Series for simpler solutions

Also available are simpler, easy-to-introduce types for the following applications. Please ask your Omron representative for details.

- Auto-focus is not necessary as the objects are of the same type with no difference in height
- Used in a dry environment, IP40 is sufficient

Choices with different I/O interfaces

- Ethernet TCP/IP

F330-F Series  
(Catalog No.Q280)



- RS-232C
- Ethernet over USB

F320-F Series  
(Catalog No.Q281)







# Omron's vision sensor series



## High-speed high-precision alignment FH Vision System

Provides high-performance inspections and measurements beyond human vision, covering from the detection of microscopic defects to the high-speed and high-precision alignment.



## High-speed appearance inspection, pre-alignment FHV7 Smart Camera

The functionality and speed enabling appearance inspection, pre-alignment, and other inspection and measurements that your production site demands are packed in an all-in-one device.



## Simple discrimination F430-F/F420-F Smart Camera

Brings simple inspections such as presence/absence or direction in a single compact device without hassle.



Note: V430-F/V420-F Series can be used if only code reading is necessary.  
Refer to the Code Reader Group Catalog (Cat. No. Q263) for details.

- Intel and Intel Core are trademarks of Intel Corporation in the U.S. and/or other countries.
- Windows is a registered trademark of Microsoft Corporation in the USA and other countries.
- Firefox is a trademark of the Mozilla Foundation in the US and other countries.
- iPhone, iPad and Safari are trademarks of Apple Inc., registered in the U.S. and other countries and regions.
- Google Chrome, Android™, Google Play, and the Google Play logo are trademarks of Google LLC.
- Microsoft product screen shot(s) used with permission from Microsoft Corporation.

**Note: Do not use this document to operate the Unit.**

## OMRON Corporation Industrial Automation Company

Kyoto, JAPAN

Contact : [www.ia.omron.com](http://www.ia.omron.com)

### Regional Headquarters

#### OMRON EUROPE B.V.

Wegalaan 67-69, 2132 JD Hoofddorp  
The Netherlands  
Tel: (31) 2356-81-300 Fax: (31) 2356-81-388

#### OMRON ELECTRONICS LLC

2895 Greenspoint Parkway, Suite 200  
Hoffman Estates, IL 60169 U.S.A.  
Tel: (1) 847-843-7900 Fax: (1) 847-843-7787

#### OMRON ASIA PACIFIC PTE. LTD.

438B Alexandra Road, #08-01/02 Alexandra  
Technopark, Singapore 119968  
Tel: (65) 6835-3011 Fax: (65) 6835-3011

#### OMRON (CHINA) CO., LTD.

Room 2211, Bank of China Tower,  
200 Yin Cheng Zhong Road,  
PuDong New Area, Shanghai, 200120, China  
Tel: (86) 21-6023-0333 Fax: (86) 21-5037-2388

Authorized Distributor:

©OMRON Corporation 2020-2023 All Rights Reserved.  
In the interest of product improvement,  
specifications are subject to change without notice.

CSM\_3\_2

Cat. No. Q272-E1-04 0623 (1219)