

Mechanically Latching Relays Based on the MM Power Relay

- Low power consumption due to mechanical latch for economic operation.
- Relays with mixed coil specifications can be produced (e.g., AC set coil and DC reset coil).
- Operational response fast enough to enable pulse signal power applications.
- Ambient operating temperature: -10°C to 55°C .

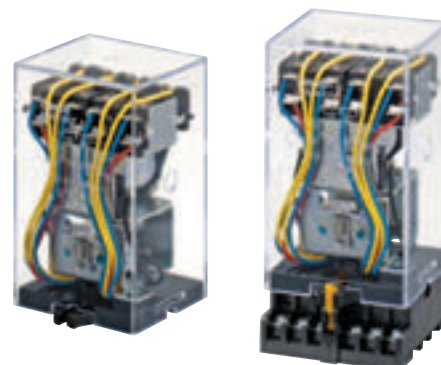

Refer to *Safety Precautions for All Relays*.

Ordering Information

Type	Contact form	Open structure		Cased
		Solder terminals	Screw terminals	Plug-in (octal pins) terminals
Standard	DPDT	MM2K	MM2KB	MM2KP
	3PDT	MM3K	MM3KB	MM3KP
	4PDT	MM4K	MM4KB	---
	DPDT+DPST-NO	---	---	MM4KP
DC-switching	DPDT	MM2XK	MM2XKB	MM2XKP
	3PDT	MM3XK	MM3XKB	MM3XKP
	4PDT	MM4XK	MM4XKB	---
	DPDT+DPST-NO	---	---	MM4XKP
Conforming to auxiliary power relay specifications	DPDT+DPST-NO	---	---	MM4KP-JD MM4XKP-JD

Models Conforming to Auxiliary Power Relay Specifications

The MM4KP-JD and MM4XKP-JD satisfy the ratings of auxiliary relays provided in JEC-2500 (1987) standards for power protective relays specified by the Japan Electromechanical Commission. Furthermore, the MM4KP-JD and MM4XKP-JD satisfy the ratings of multi-contact relays provided in JEC-174D (1979) standards for power auxiliary relays.

These models work at operation level A specified by JEC-174D (1979) standards and the hot start of the relays is possible after the coils radiate heat.

In accordance with JEC-2500 (1987) standards, the coil of each model withstands a 130% DC load or 115% AC load.

Note: When ordering, add the rated coil voltage to the model number. Rated coil voltages are given in the coil ratings table.

Example: MM2K, 6 VAC

Rated coil voltage

Available Models

When your order, specify the rated voltage.

Open Coils (with Solder Terminals)

Type	Contact form	Relay model	Available rated voltage
Standard	DPDT	MM2K	100/(110), 200/(220) VAC 12, 24, 48, 100/110, 200/220 VDC
	3PDT	MM3K	100/(110), 200/(220) VAC 48, 100/110 VDC
	4PDT	MM4K	200/(220) VAC 12, 24, 48, 100/110, 200/220 VDC
DC-switching	DPDT	MM2XK	24, 100/110 VDC
	3PDT	MM3XK	200/(220) VAC 100/110 VDC
	4PDT	MM4XK	100/(110) VAC 100/110 VDC

Open Coils (with Screw Terminals)

Type	Contact form	Relay model	Available rated voltage
Standard	DPDT	MM2KB	100/(110), 200/(220) VAC 12, 24, 48, 100/110 VDC
	3PDT	MM3KB	100/(110), 200/(220) VAC 12, 48, 100/110 VDC
	4PDT	MM4KB	24, 100/(110), 200/(220) VAC 100/110 VDC
DC-switching	DPDT	MM2XKB	100/(110), 200/(220) VAC 12, 24, 48, 100/110, 200/220 VDC
	3PDT	MM3XKB	200/(220) VAC 24, 100/110 VDC
	4PDT	MM4XKB	24, 48, 100/110, 125, 200/220 VDC

Cased Coils (Plug-in Terminals)

Type	Contact form	Relay model	Available rated voltage
Standard	DP	MM2KP	6, 12, 24, 100/(110), 200/(220) VAC 12, 24, 48, 100/110, 125, 200/220 VDC
	3P	MM3KP	24, 100/(110), 200/(220) VAC 6, 12, 24, 48, 100/110, 125, 200/220 VDC
	4P	MM4KP	24, 100/(110), 200/(220) VAC 6, 12, 24, 48, 100/110, 125, 200/220 VDC
DC-switching	DP	MM2XKP	24, 100/(110), 200/(220) VAC 12, 24, 48, 100/110, 125, 200/220 VDC
	3P	MM3XKP	100/(110), 200/(220) VAC 24, 48, 100/110, 125, 200/220 VDC
	4P	MM4XKP	100/(110), 200/(220) VAC 6, 12, 24, 48, 100/110, 125, 200/220 VDC
Conforming to auxiliary power relay specifications	4P	MM4KP-JD	24, 100/(110), 115, 200/(220) VAC 24, 100/110, 125, 200/220 VDC
Conforming to auxiliary power relay specifications for DC-switching	4P	MM4XKP-JD	100/(110), 115, 200/(220) VAC 24, 48, 100/110, 125, 200/220 VDC

Model Number Legend

MM□□K□
1 2 3

1. Contact Form

- 2: DPDT
- 3: 3PDT
- 4: 4PDT (open structure type)/
DPDT+DPST-NO (cased type)

2. Type (see note)

- None: Standard
- X: DC-switching



3. Terminal Shape

- None: Solder
- B: Screw
- P: Plug-in

Note: The suffix "JD" indicates models conforming to auxiliary power relay specifications.

■ Accessories (Order Separately)

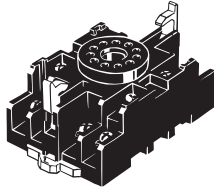
Sockets

Relay	DIN Track/Front-connecting Socket	Back-connecting Socket
	Screw terminals	Solder terminals
MM2(X)KP	11PFA 	PL11 
MM3(X)KP MM4(X)KP	14PFA	PL15
MM4(X)KP-JD	14PFA	---

Mounting Brackets

Contact form	Model
DPDT	R99-03 (S KANAGU) FOR MM2K.611K
3PDT	R99-03 (S KANAGU) FOR MM3K.612K
4PDT	R99-03 (S KANAGU) FOR MM4K.613K

Specifications

■ Coil Ratings

Set Coil

Rated voltage (V)	Rated current (mA)								Coil resistance (Ω)		Set volt.	Max volt.	Power consumption (VA or W)	
	DP				3P, 4P				DP	3P, 4P				
	Open Relays		Cased		Open Relays		Cased				% of rated voltage			
50 Hz	60 Hz	50 Hz	60 Hz	50 Hz	60 Hz	50 Hz	60 Hz	50 Hz	60 Hz	DP	3P, 4P			
AC	6	790	655	690	590	1,285	1,100	1,165	1,000	1.1	0.46	80% max.	110%	Initial: DP: Approx. 6.2 3P, 4P: Approx. 12 Rated: DP: Approx. 3.5 (3.9) 3P, 4P: Approx. 6 (6.6)*
	12	395	325	345	295	640	550	580	500	4.7	1.9			
	24	195	160	170	145	320	275	290	250	19	8.2			
	100/ (110)	47	39/45	41	35/40	77	66/76	70	60/68	340	141			
	200/ (220)	23.5	19.5/ 22.5	20.5	17.5/ 20	38.5	33/38	35	30/34	1,540	563			
DC	6	340				450				17.5	13.4		DP: Approx. 2.1 3P, 4P: Approx. 2.7	
	12	176				220				68	54			
	24	87				94				275	255			
	48	41				52				1,180	930			
	100/ 110	17/19				22/24.5				5,750	4,500			
	125	17				22				7,430	5,800			
	200/ 220	8.6/9.5				11/12				23,200	18,000			

Note: 1. The rated current and coil resistance are measured at a coil temperature of 23°C with tolerances of +15%/–20% for AC rated current and ±15% for DC coil resistance.

2. Performance characteristic data are measured at a coil temperature of 23°C.

3. The AC coil resistance values are reference values.

4. The maximum voltage is one that is applicable instantaneously to the Relay coil at an ambient temperature of 23°C and not continuously.

*Values in parentheses are for open relays.

Reset Coil

Rated voltage (V)	Rated current (mA)		Coil resistance (Ω)	Reset voltage	Maximum voltage	Power consumption (VA or W)		
	50 Hz	60 Hz		% of rated voltage				
AC	6	770	690	2.3	80% max.	110%	Initial: Approx. 6.5 Rated: Approx. 4.1	
	12	385	345					9.2
	24	191	170					35
	100/(110)	46	41/46					739
	200/(220)	23	20/23					3,030
DC	6	422		14.2	14.2	Approx. 2.8		
	12	215		56				
	24	109		220				
	48	58		832				
	100/110	25/27		4,040				
	125	23.5		5,330				
	200/220	12.2/13.5		16,330				

- Note:**
1. The rated current and coil resistance are measured at a coil temperature of 23°C with tolerances of +15%/–20% for AC rated current and ±15% for DC coil resistance.
 2. Performance characteristic data are measured at a coil temperature of 23°C.
 3. The AC coil resistance values are reference values.
 4. The maximum voltage is one that is applicable instantaneously to the Relay coil at an ambient temperature of 23°C and not continuously.

Coils (Conforming to Auxiliary Power Relay Specifications)

Rated voltage (V)	Rated current (mA)				Coil resistance (Ω)		Set voltage	Reset voltage	Max. voltage	Operation level (JEC-174D)	Power consumption (VA or W)				
	Set coil		Reset coil		Set coil	Reset coil					Set coil		Reset coil		
	50 Hz	60 Hz	50 Hz	60 Hz							Initial	Rated	Initial	Rated	
AC	24	245	210	191	170	8.5	35	80% max.	80% max.	110%	A	Approx. 6.3	Approx. 5.1	Approx. 6.5	Approx. 4.1
	100/(110)	58.5	51/58	46	41/46	150	739								
	110	53	46	42	37.3	182	835								
	115	51	44	40	35.7	210	885								
	200/(220)	29	25.5/29	23	20.5/23	620	3,030								
	220	26.5	23	21	18.6	780	3,420								
DC	24	94		109		255	220	255	832	4,500	4,040	Approx. 2.7	Approx. 2.8		
	48	52		58		930	832								
	100/110	22/24.5		25/27		4,500	4,040								
	125	22		23.5		5,800	5,330								
	200/220	11/12		12.2/13.5		18,000	16,330								

- Note:**
1. The rated current and coil resistance are measured at a coil temperature of 23°C with tolerances of +15%/–20% for AC rated current and ±15% for DC coil resistance.
 2. The AC coil resistance and coil inductance values are for reference only.
 3. Performance characteristic data are measured at a coil temperature of 23°C.
 4. The maximum voltage is one that is applicable instantaneously to the Relay coil at an ambient temperature of 23°C and not continuously.

■ Contact Ratings

Standard Relays

Item	Open Relays: MM2K(B), MM3K(B), MM4K(B)		Cased Relays: MM2KP, MM3KP, MM4KP	
	Resistive load ($\cos\phi = 1$)	Inductive load ($\cos\phi=0.4, L/R=7$ ms)	Resistive load ($\cos\phi = 1$)	Inductive load ($\cos\phi=0.4, L/R=7$ ms)
Contact mechanism	Single			
Contact material	Ag			
Rated load	10 A at 220 VAC 7 A at 24 VDC		5 A at 220 VAC 4 A at 24 VDC	
Rated carry current	10 A		5 A	
Max. switching voltage	250 VAC, 250 VDC		250 VAC, 250 VDC	
Max. switching current	10 A		5 A	
Max. switching power (reference value)	2,200 VA, 168 W		1,100 VA, 96W	

DC-switching Relays

Item	Open Relays: MM2XK(B), MM3XK(B), MM4XK(B)		Cased Relays: MM2XKP, MM3XKP, MM4XKP	
	Resistive load ($\cos\phi = 1$)	Inductive load ($\cos\phi=0.4, L/R=7$ ms)	Resistive load ($\cos\phi = 1$)	Inductive load ($\cos\phi=0.4, L/R=7$ ms)
Contact mechanism	Single			
Contact material	Ag			
Rated load	7 A at 110 VDC	6 A at 110 VDC	5 A at 110 VDC	
Rated current flow	10 A		5 A	
Max. switching voltage	250 VAC, 250 VDC		250 VAC, 250 VDC	
Max. switching current	10 A		5 A	
Max. switching power (reference value)	800 W, 20 VA *1	660 W, 20 VA *1	700 W, 20 VA *1	600 W, 20 VA *1

- Note: 1.** When switching DC inductive loads at 125 V or more, an unstable region exists for a switching current of between 0.5 and 2.5 A. The Relay will not turn OFF in this region. Use a switching current of 0.5 A or less when switching 125 VDC or more.
- 2.** If L/R exceeds 7 ms when switching DC inductive loads, an arc-breaking time of up to 50 ms must be considered in application and the circuit must be designed to ensure that an arc-breaking time of 50 ms is not exceeded.
- *1.Refer to Switching an *Switching an AC Load with a DC-switching Model ("X" Model)* on page 13.

Contacts (Conforming to Auxiliary Power Relay Specifications)

Item	MM4KP-JD		MM4XKP-JD	
	Resistive load ($\cos\phi = 1$)	Inductive load ($\cos\phi = 0.4, L/R = 7$ ms)	Resistive load ($\cos\phi = 1$)	Inductive load ($\cos\phi = 0.4, L/R = 7$ ms)
Contact mechanism	Single			
Contact material	Ag			
Rated load	5 A at 220 VAC, 4 A at 24 VDC		5 A at 110 VDC	
Rated carry current	5 A			
Max. switching voltage	250 VAC, 250 VDC			
Max. switching current	5 A			

- Note: 1.** When switching DC inductive loads at 125 V or more, an unstable region exists for a switching current of between 0.5 and 2.5 A. The Relay will not turn OFF in this region. Use a switching current of 0.5 A or less when switching 125 VDC or more.
- 2.** If L/R exceeds 7 ms when switching DC inductive loads, an arc-breaking time of up to 50 ms must be considered in application and the circuit must be designed to ensure that an arc-breaking time of 50 ms is not exceeded.

■ Characteristics

Item	Open or bifurcated-contact Relays														
Contact resistance (see note 2)	50 mΩ max.														
Set time (see note 3)	AC: 30 ms max.; DC: 60 ms max. (minimum pulse width for AC and DC: 100 ms)														
Reset time (see note 3)	30 ms max. (minimum pulse width for AC and DC: 100 ms)														
Max. operating frequency	Mechanical: 1,800 operations/hr Electrical: 1,800 operations/hr (under rated load)														
Insulation resistance (see note 4)	100 MΩ min. (at 500 VDC)														
Dielectric strength	1,500 VAC, 50/60 Hz for 1 min between contacts of same polarity 2,000 VAC, 50/60 Hz for 1 min between contacts of different polarity, between contacts and coil, and between set and reset coils														
Vibration resistance	Destruction: 10 to 55 to 10 Hz, 0.375 mm single amplitude (0.75 mm double amplitude) Malfunction: 10 to 35 to 10 Hz, 0.5 mm single amplitude (1.0 mm double amplitude)														
Shock resistance	Destruction: 500 m/s ² Malfunction: 50 m/s ²														
Endurance	Mechanical: 2,500,000 operations min. (at 1,800 operations/hr) Electrical: 500,000 operations min. (at 1,800 operations/hr under rated load) (see note 5)														
Error rate (level P) (Reference value) (see note 6)	10 mA at 5 VDC														
Ambient temperature	Operating: -10°C to 55°C (with no icing or condensation)														
Ambient humidity	Operating: 5% to 85%														
Weight	<table border="0"> <thead> <tr> <th>Standard Relays</th> <th>DC-switching Relays</th> </tr> </thead> <tbody> <tr> <td>MM2K: Approx. 255 g</td> <td>MM2XK: Approx. 260 g</td> </tr> <tr> <td>MM3K: Approx. 390 g</td> <td>MM2XK: Approx. 395 g</td> </tr> <tr> <td>MM4K: Approx. 420 g</td> <td>MM4XK: Approx. 430 g</td> </tr> <tr> <td>MM2KP: Approx. 375 g</td> <td>MM2XKP: Approx. 380 g</td> </tr> <tr> <td>MM3KP: Approx. 550 g</td> <td>MM3XKP: Approx. 555 g</td> </tr> <tr> <td>MM4KP: Approx. 570 g</td> <td>MM4XKP: Approx. 580 g</td> </tr> </tbody> </table>	Standard Relays	DC-switching Relays	MM2K: Approx. 255 g	MM2XK: Approx. 260 g	MM3K: Approx. 390 g	MM2XK: Approx. 395 g	MM4K: Approx. 420 g	MM4XK: Approx. 430 g	MM2KP: Approx. 375 g	MM2XKP: Approx. 380 g	MM3KP: Approx. 550 g	MM3XKP: Approx. 555 g	MM4KP: Approx. 570 g	MM4XKP: Approx. 580 g
Standard Relays	DC-switching Relays														
MM2K: Approx. 255 g	MM2XK: Approx. 260 g														
MM3K: Approx. 390 g	MM2XK: Approx. 395 g														
MM4K: Approx. 420 g	MM4XK: Approx. 430 g														
MM2KP: Approx. 375 g	MM2XKP: Approx. 380 g														
MM3KP: Approx. 550 g	MM3XKP: Approx. 555 g														
MM4KP: Approx. 570 g	MM4XKP: Approx. 580 g														

Note: 1. The data shown above are initial values.

- The contact resistance was measured with 1 A at 5 VDC using the voltage drop method.
- The set or reset time was measured with the rated voltage imposed with any contact bounce ignored at an ambient temperature of 23°C.
- The insulation resistance was measured with a 500-VDC megger applied to the same places as those used for checking the dielectric strength.
- The electrical endurance was measured at an ambient temperature of 23°C.
- This value was measured at a switching frequency of 60 operations per minute.

■ Characteristics (Conforming to Auxiliary Power Relay Specifications)

Vibration resistance	Destruction: 10 to 55 to 10 Hz, 0.375 mm single amplitude (0.75 mm double amplitude) Malfunction: 10 to 22 to 10 Hz, 0.5 mm single amplitude (1.0 mm double amplitude)
Shock resistance	Destruction: 300 m/s ² Malfunction: 30 m/s ²
Endurance	Mechanical: 2,500,000 operations min. (at 1,800 operations/hr) Electrical: 500,000 operations min. (at 1,800 operations/hr under rated load) (see note 2)
Error rate (level P) (Reference value) (see note 3)	10 mA at 5 VDC
Ambient temperature	Operating: -10°C to 40°C (with no icing or condensation)
Ambient humidity	Operating: 5% to 85%
Weight	MM4KP-JD: Approx. 570 g MM4XKP-JD: Approx. 580 g

Note: 1. The data shown above are initial values.

- The electrical endurance was measured at an ambient temperature of 23°C.
- This value was measured at a switching frequency of 60 operations per minute.

Engineering Data

Standard Relays

Maximum Switching Power

Open Relays

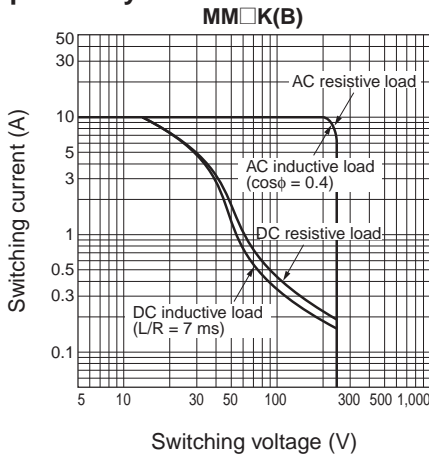

Cased Relays

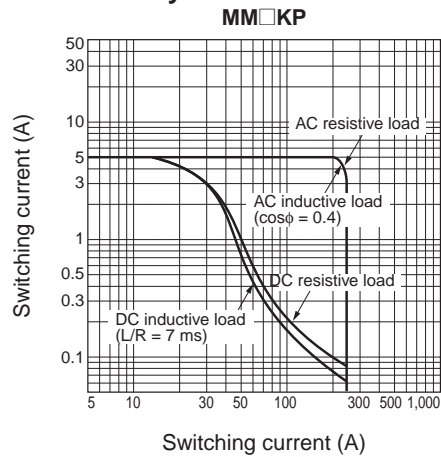

Endurance Curves

Open Relays

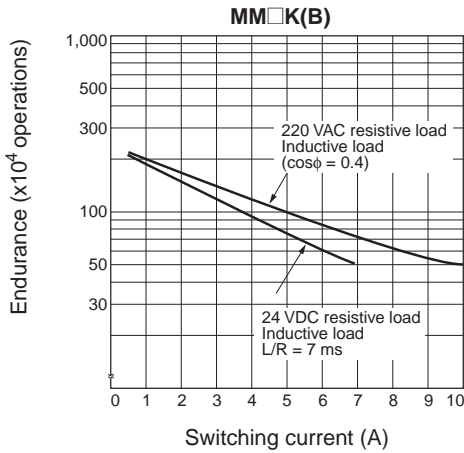

Cased Relays

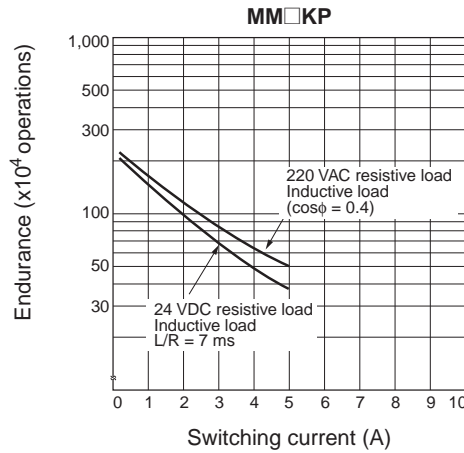

DC-switching Relays

Maximum Switching Power

Open Relays

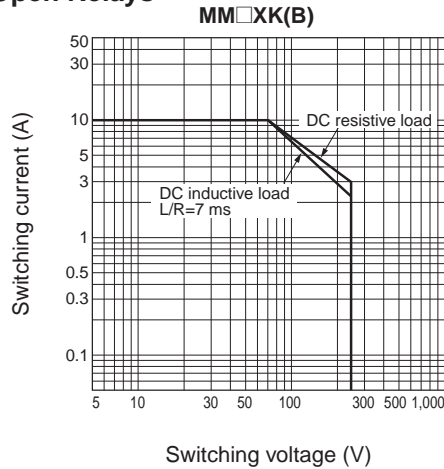

Cased Relays

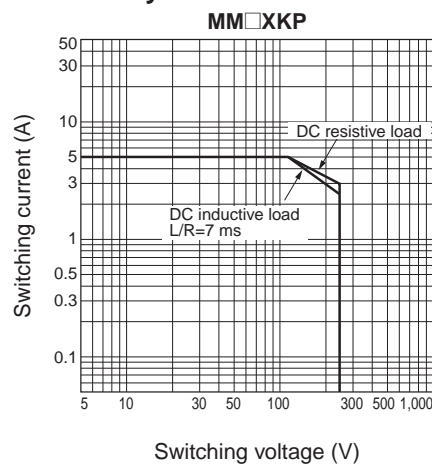

Endurance Curves

Open Relays

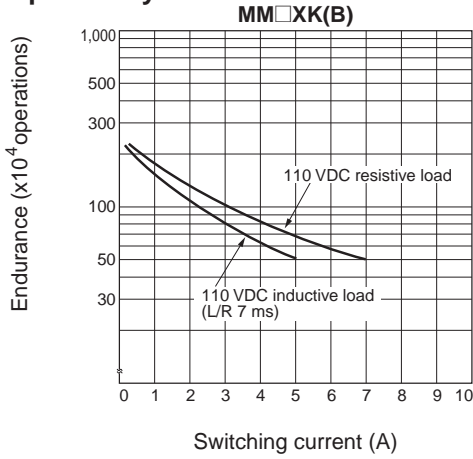

Cased Relays

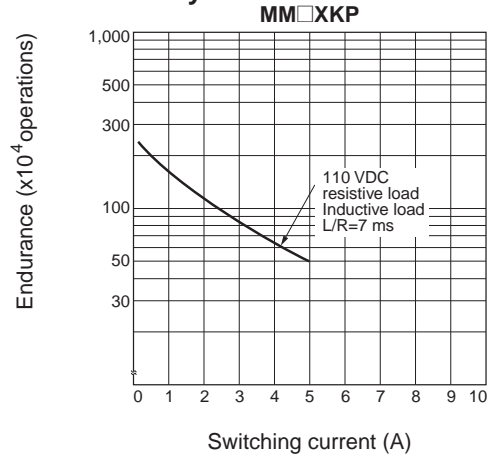

Relays Conforming to Auxiliary Power Relay Specifications

Maximum Switching Power

MM4KP-JD

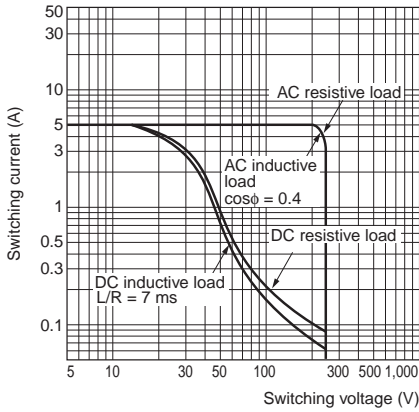

MMX4KP-JD

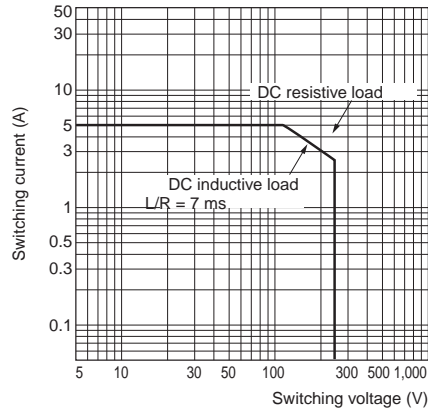

Endurance Curves

MM4KP-JD

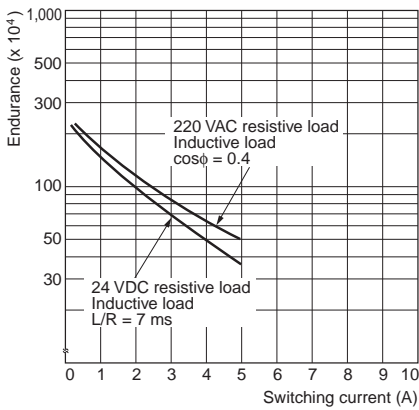

MM4XKP-JD

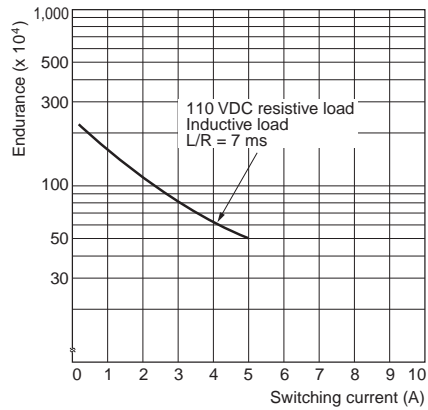

Ambient Temperature vs. Set and Reset Voltage

MM4KP AC (60 Hz)

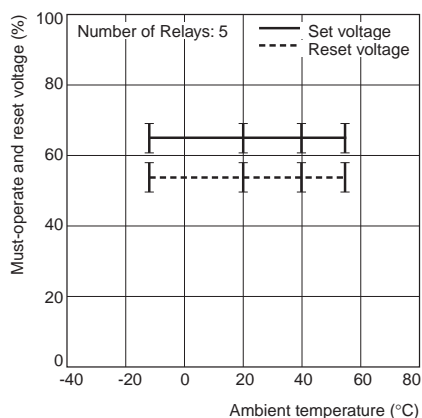

Ambient Temperature vs. Coil Temperature Rise

MM4KP 110 VAC (60 Hz)

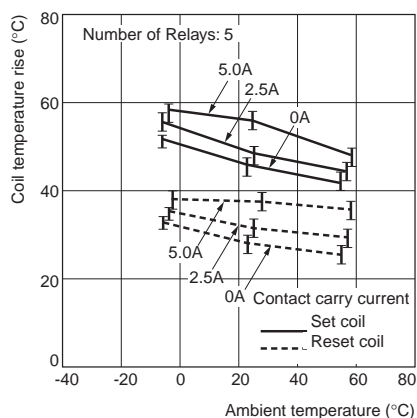

Malfunctioning Shock

MM4(X)KP

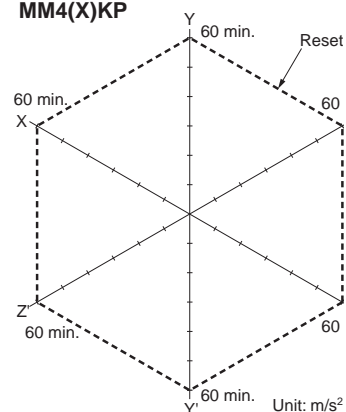

Number of samples: 3

Measurement conditions: Impose a shock of 50 m/s² in the ±X, ±Y, and ±Z directions three times each with the Relay energized and re-energized to check the shock values that cause the Relay to malfunction.

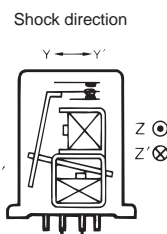

MM4KP DC

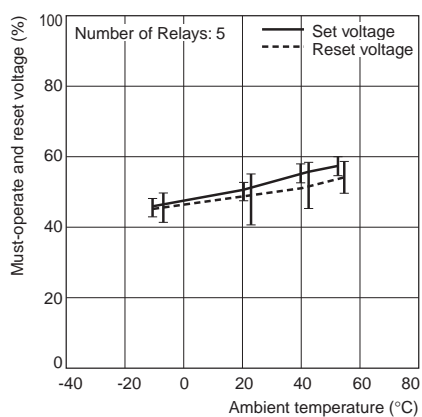

MM4KP DC

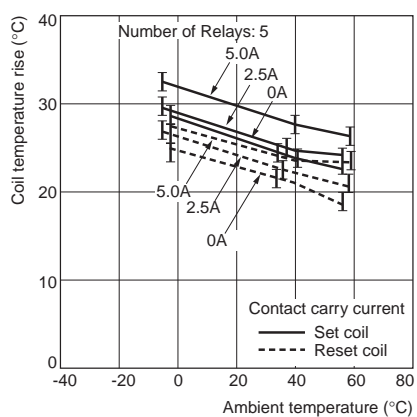

Dimensions

Note: All units are in millimeters unless otherwise indicated.

Open Relays with Solder Terminals

MM2(X)K,
MM3(X)K,
MM4(X)K

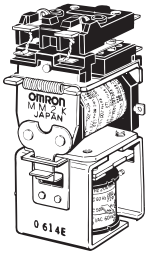

MM2K

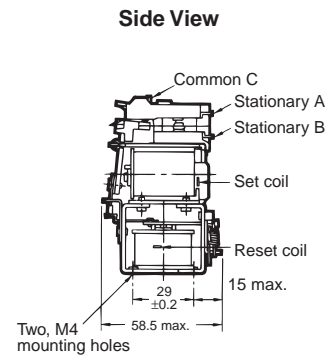
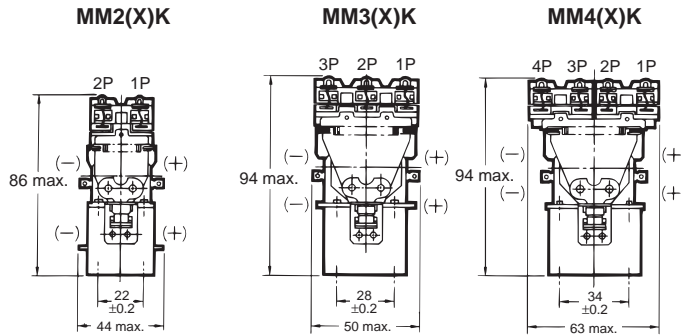

Note: Connect the common (C) of MM□XK to positive (+).

Open Relays with Screw Terminals

MM2(X)KB,
MM3(X)KB,
MM4(X)KB

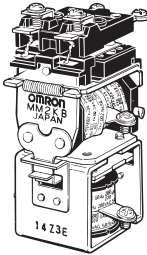

MM2KB

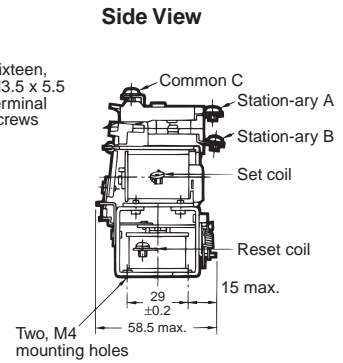
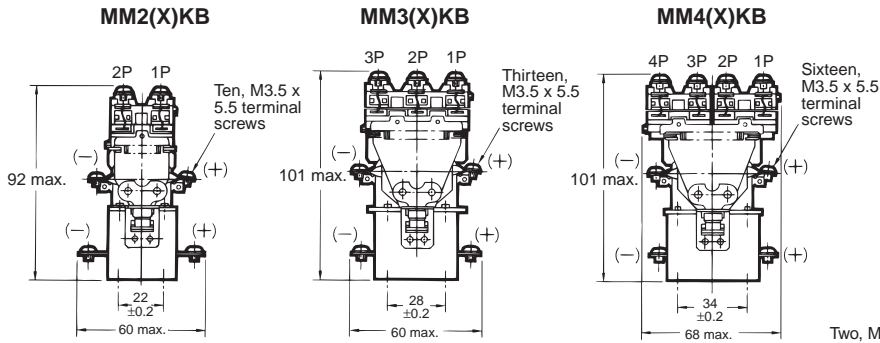

Note: Connect the common (C) of MM□XKB to positive (+).

Mounting Holes (Direct Mounting)

Note: The tolerance is ± 0.2 .

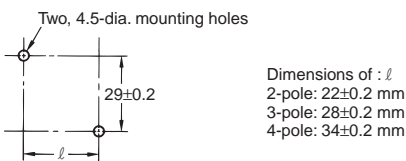

Mounting Bracket (S Bracket)

R99-03 (S KANAGU) FOR MM□

The S Bracket can be used to mount a Relay with open solder or screw terminals.

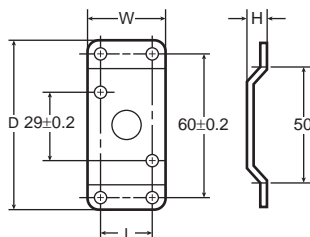
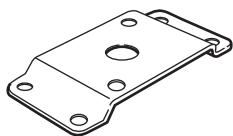

Item	R99-03 (S KANAGU) FOR MM2K.611K (DPDT)	R99-03 (S KANAGU) FOR MM3K.612K (3PDT)	R99-03 (S KANAGU) FOR MM4K.613K (4PDT)
l	22±0.2	28±0.2	34±0.2
D	71 max.	71 max.	71 max.
W	33 max.	39 max.	45 max.
H	6 max.	6 max.	6 max.

■ Cased Relays with Plug-in Terminal

MM2(X)KP

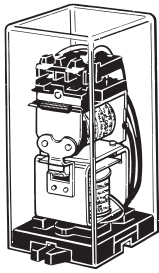

MM2KP

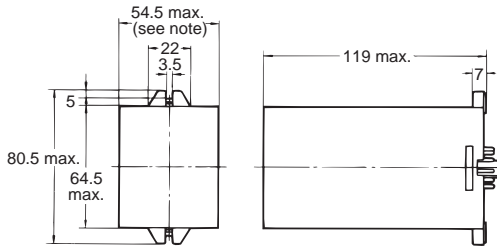

Note: It is recommended that 55 mm min. is allowed for this side because the MM2XKP has a curved protective plate on the side.

Terminal Arrangement/ Internal Connections (Bottom View)

Standard Relays MM2KP

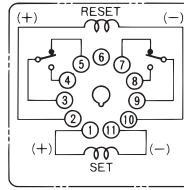

DC-switching Relays MM2XKP

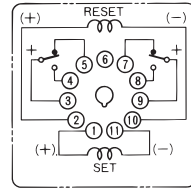

Note1: Connect the common (C) to positive (+).

Make sure that all common connections are the same in polarity. The markings of the common connections on the casing all show "+" but the polarity of the common connections can be either all negative or all positive.

Note2: The terminals in the Terminal Arrangement/Internal Connections diagram where nothing is connected are unused terminals. These may be empty but this is not a problem.

MM3(X)KP MM4(X)KP

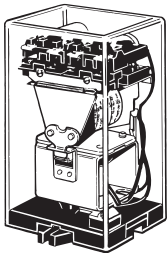

MM4KP

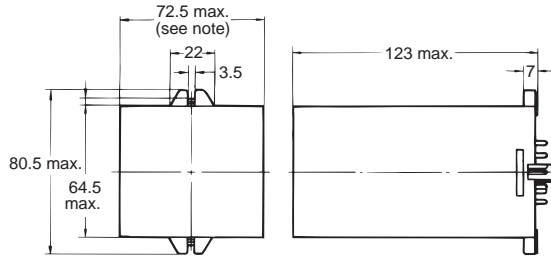

Note: It is recommended that 73 mm min. is allowed for this side because the MM3XKP and MM4XKP have a curved protective plate on the side.

Terminal Arrangement/ Internal Connections (Bottom View)

Standard Relays

MM3KP

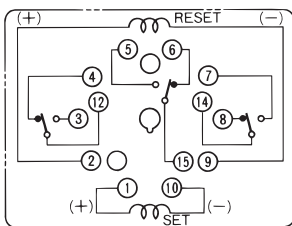

MM4KP

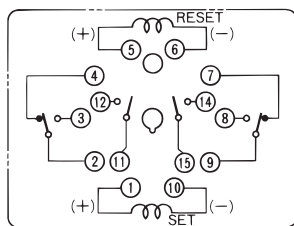

DC-switching Relays

MM3XKP

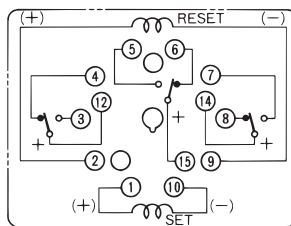

MM4XKP

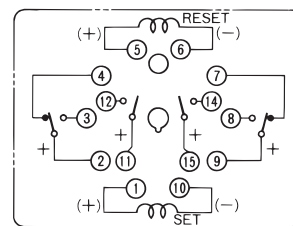

Note1: Connect the common (C) to positive (+).

Make sure that all common connections are the same in polarity. The markings of the common connections on the casing all show "+" but the polarity of the common connections can be either all negative or all positive.

Note2: The terminals in the Terminal Arrangement/Internal Connections diagram where nothing is connected are unused terminals. These may be empty but this is not a problem.

Cases on Models for Switching DC Loads

As shown at the right, there are three holes with a 10-mm diameter in the case.

Case Protective Plate

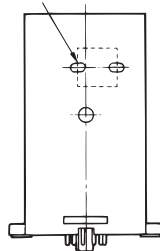

Be sure the polarity is correct when connecting Exposed Models.

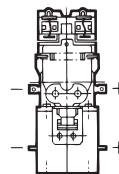

This example is for the MN2XK.
This also applies to models with 3 or 4 poles.

MM4KP-JD

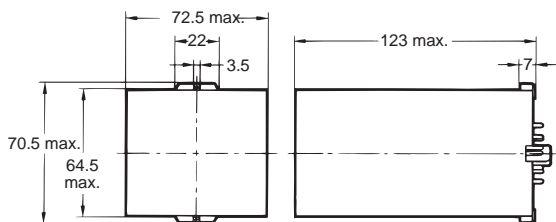
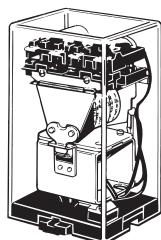

Terminal Arrangement/
Internal Connections
(Bottom View)

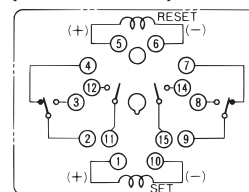

Note1: The MM4KP-JD is DPDT and DPST-NO.

Note2: The terminals in the Terminal Arrangement/Internal Connections diagram where nothing is connected are unused terminals. These may be empty but this is not a problem.

MM4XKP-JD

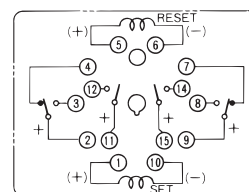
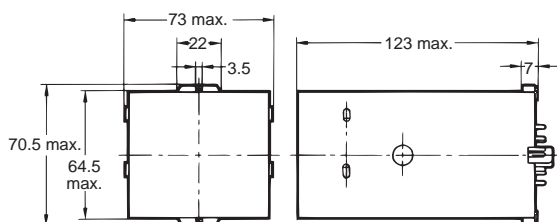
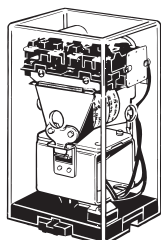



Note1: The MM4XKP-JD is DPDT and DPST-NO. Make sure that all common connections are the same in polarity. The mark-ings of the common connections on the casing all show "+" but the polarity of the common connections can be either all negative or all positive.

Note2: The terminals in the Terminal Arrangement/Internal Connections diagram where nothing is connected are unused terminals. These may be empty but this is not a problem.

Accessories

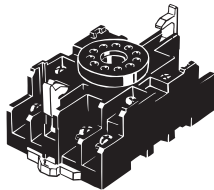
■ Sockets

Relay model	DIN Track/Front-connecting Socket	Back-connecting Socket
	Screw terminals	Solder terminals
MM2(X)KP	11PFA 	PL11 
MM3(X)KP MM4(X)KP	14PFA	PL15
MM4(X)KP-JD	14PFA	---

Note: When using the MM□KP-JD by itself, the PL15 Back-connecting Socket cannot be used.

■ Height with Socket

DIN Track/Front-connecting Socket

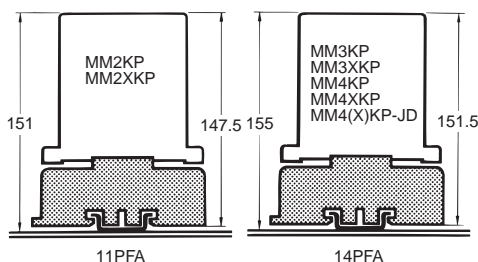

Back-connecting Socket

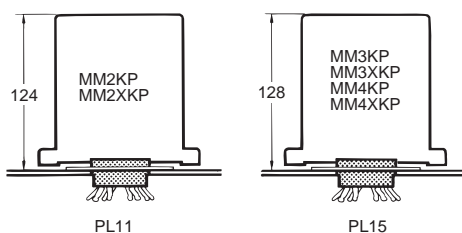

Note: □PFA can be both track-mounted and screw-mounted.

Safety Precautions

Refer to *Safety Precautions for All Relays*.

■ Mounting

Make sure that the Relay is free from iron powder or iron core, otherwise the iron dust may adhere to the Relay. As a result the movable contact may not operate properly.

An arc may be generated between the contacts in switching operation. Be sure to keep combustible objects away from the Relay. If the arc will have a bad effect around the Relay, the use of a model with a casing is recommended.

A model switching DC load incorporates an insulation base with a small built-in permanent magnet. Be sure to keep magnets or ferrous objects away from the permanent magnet, otherwise the capacity of the maximum switching current may drop.

The PL Back-connecting Socket must be flush-mounted from the surface of the panel.

To minimize the influence of heat, separate Relays from each other by at least 20 mm for cooling when mounting multiple Relays together.

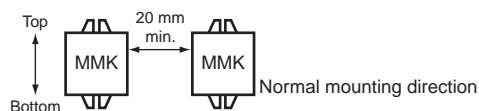

Be sure to mount the Relay so that the movable contact is in the downward direction.

■ Connection

- When connecting a load to the contact terminals of a model for switching DC loads ("X" models), consider the polarity of the contact terminals so that the generated arcs on the adjacent poles will not collide. (For example, if the common connections of the Relay are all positive or all negative, no arc collision will occur.)
- Use proper crimp terminals or 1.2- to 2-mm-dia. single-conductor wire to connect screw terminals.

Screw Terminal Model

Do not bend the coil terminals, otherwise the coil wire may be disconnected. Make sure that the tightening torque applied to each terminal is 1.27 N · m and the insertion force is 49 N for 10 s.

Solder Terminal Model

Make sure that Relay terminals are free of flux or other foreign substance before soldering the Relay terminals. Finish soldering the Relay terminals quickly, otherwise the coil wire may be broken.

■ Circuits

- You cannot use single contact to demagnetize the set coil as shown below.

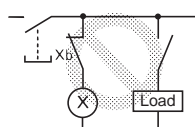

⊗ : Latching Relay coil
xb : NC contact of the Relay

- NC contacts can remain open for a few milliseconds when the reset coil turns ON and OFF. NO contact can remain open for a few milliseconds when the set coil turns ON and OFF while the Relay is latched. Design your circuits to allow for this.

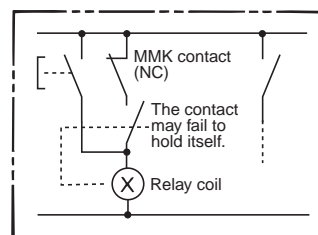

- Do not allow voltage to be applied simultaneously to both the set and reset coil. If voltage is applied simultaneously, the Relay will be set.
- There is no reason to apply voltage to Latching Relays continuously because they will latch properly with a single pulse of sufficient width. Continuously applying voltage will only waste power.
- A model for DC loads incorporates a permanent magnetic for arc suppression. Keep floppy disks away from the Relay, otherwise the data on the floppy disk may be damaged.
- Arcing when switching DC power can cause nitric gas to be generated. The case of the MM□XKP contains holes to allow the gas to escape. This, however, makes it possible for dust and dirt to enter the case. Be sure to use the MM□XKP in a suitable environment.

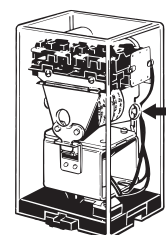

■ Switching an AC Load with a DC-switching Model ("X" Model)

DC-switching Relays ("X" models) use a magnet to extinguish arcs. The polarity must be correct when you connect the switching section. However, if you connect an AC load, the positive and negative poles of the power supply alternate. This can cause short-circuits due to the collision of arcs that occur when the Relay turns OFF. Therefore, the switching capacity for an AC load is specified as 20 VA or less to prevent short circuits caused by arc collisions. Take sufficient caution if you switch an AC Load with a DC-switching model ("X" models).

■ Refer to the technical guide on your OMRON website for technical descriptions and FAQs on the product.

ALL DIMENSIONS SHOWN ARE IN MILLIMETERS.

To convert millimeters into inches, multiply by 0.03937. To convert grams into ounces, multiply by 0.03527.

In the interest of product improvement, specifications are subject to change without notice.

Terms and Conditions Agreement

Read and understand this catalog.

Please read and understand this catalog before purchasing the products. Please consult your OMRON representative if you have any questions or comments.

Warranties.

(a) Exclusive Warranty. Omron's exclusive warranty is that the Products will be free from defects in materials and workmanship for a period of twelve months from the date of sale by Omron (or such other period expressed in writing by Omron). Omron disclaims all other warranties, express or implied.

(b) Limitations. OMRON MAKES NO WARRANTY OR REPRESENTATION, EXPRESS OR IMPLIED, ABOUT NON-INFRINGEMENT, MERCHANTABILITY OR FITNESS FOR A PARTICULAR PURPOSE OF THE PRODUCTS. BUYER ACKNOWLEDGES THAT IT ALONE HAS DETERMINED THAT THE PRODUCTS WILL SUITABLY MEET THE REQUIREMENTS OF THEIR INTENDED USE.

Omron further disclaims all warranties and responsibility of any type for claims or expenses based on infringement by the Products or otherwise of any intellectual property right. (c) Buyer Remedy. Omron's sole obligation hereunder shall be, at Omron's election, to (i) replace (in the form originally shipped with Buyer responsible for labor charges for removal or replacement thereof) the non-complying Product, (ii) repair the non-complying Product, or (iii) repay or credit Buyer an amount equal to the purchase price of the non-complying Product; provided that in no event shall Omron be responsible for warranty, repair, indemnity or any other claims or expenses regarding the Products unless Omron's analysis confirms that the Products were properly handled, stored, installed and maintained and not subject to contamination, abuse, misuse or inappropriate modification. Return of any Products by Buyer must be approved in writing by Omron before shipment. Omron Companies shall not be liable for the suitability or unsuitability or the results from the use of Products in combination with any electrical or electronic components, circuits, system assemblies or any other materials or substances or environments. Any advice, recommendations or information given orally or in writing, are not to be construed as an amendment or addition to the above warranty.

See <http://www.omron.com/global/> or contact your Omron representative for published information.

Limitation on Liability: Etc.

OMRON COMPANIES SHALL NOT BE LIABLE FOR SPECIAL, INDIRECT, INCIDENTAL, OR CONSEQUENTIAL DAMAGES, LOSS OF PROFITS OR PRODUCTION OR COMMERCIAL LOSS IN ANY WAY CONNECTED WITH THE PRODUCTS, WHETHER SUCH CLAIM IS BASED IN CONTRACT, WARRANTY, NEGLIGENCE OR STRICT LIABILITY.

Further, in no event shall liability of Omron Companies exceed the individual price of the Product on which liability is asserted.

Suitability of Use.

Omron Companies shall not be responsible for conformity with any standards, codes or regulations which apply to the combination of the Product in the Buyer's application or use of the Product. At Buyer's request, Omron will provide applicable third party certification documents identifying ratings and limitations of use which apply to the Product. This information by itself is not sufficient for a complete determination of the suitability of the Product in combination with the end product, machine, system, or other application or use. Buyer shall be solely responsible for determining appropriateness of the particular Product with respect to Buyer's application, product or system. Buyer shall take application responsibility in all cases.

NEVER USE THE PRODUCT FOR AN APPLICATION INVOLVING SERIOUS RISK TO LIFE OR PROPERTY OR IN LARGE QUANTITIES WITHOUT ENSURING THAT THE SYSTEM AS A WHOLE HAS BEEN DESIGNED TO ADDRESS THE RISKS, AND THAT THE OMRON PRODUCT(S) IS PROPERLY RATED AND INSTALLED FOR THE INTENDED USE WITHIN THE OVERALL EQUIPMENT OR SYSTEM.

Programmable Products.

Omron Companies shall not be responsible for the user's programming of a programmable Product, or any consequence thereof.

Performance Data.

Data presented in Omron Company websites, catalogs and other materials is provided as a guide for the user in determining suitability and does not constitute a warranty. It may represent the result of Omron's test conditions, and the user must correlate it to actual application requirements. Actual performance is subject to the Omron's Warranty and Limitations of Liability.

Change in Specifications.

Product specifications and accessories may be changed at any time based on improvements and other reasons. It is our practice to change part numbers when published ratings or features are changed, or when significant construction changes are made. However, some specifications of the Product may be changed without any notice. When in doubt, special part numbers may be assigned to fix or establish key specifications for your application. Please consult with your Omron's representative at any time to confirm actual specifications of purchased Product.

Errors and Omissions.

Information presented by Omron Companies has been checked and is believed to be accurate; however, no responsibility is assumed for clerical, typographical or proofreading errors or omissions.