

Long-distance Model with a Sensing distance of 50 mm.



⚠ Be sure to read *Safety Precautions* on page 3.

Ordering Information

Appearance	Sensing distance	Output configuration	Model
Column type (flat-surface mounting)	50 mm	3-wire DC (normally open)	TL-LP50 1M
		2-wire AC (normally open)	TL-LY50 1M

Note: Models with different frequencies are available. The model numbers are TL-L□50B.

Ratings and Specifications

Item		Model	TL-LP50	TL-LY50
Sensing distance			50 mm±10%	
Set distance			0 to 40 mm	
Differential travel			10% max. of sensing distance	
Sensing object			Ferrous metals (The sensing distance decreases with non-ferrous metal. Refer to <i>Engineering Data</i> on the next page.)	
Standard sensing object			Iron, 100 × 100 × 1 mm	
Response time			15 ms max.	25 ms max.
Power supply voltage (operating voltage range *)			12 to 24 VDC (10 to 30 VDC), ripple (p-p) 10% max.	100 to 220 VAC (90 to 250 VAC), 50/60 Hz
Current consumption			10 mA max. (with no load)	---
Leakage current			---	Refer to <i>Engineering Data</i> on the next page.
Control output	Switching capacity		NPN open collector with a maximum current of 200 mA at 30 VDC	10 to 200 mA
	Residual voltage		3 V max. under a load current of 200 mA and a cable length of 2 m	Refer to <i>Engineering Data</i> on the next page.
Indicators			Operation indicator (red)	
Operation mode (with sensing object approaching)			NO. Refer to the timing charts under <i>I/O Circuit Diagrams</i> on page 3 for details.	
Ambient temperature			Operating/Storage: -25 to 70°C (with no icing or condensation)	
Ambient humidity			Operating/Storage: 35% to 95% (with no condensation)	
Temperature influence			±10% max. of sensing distance at 23°C in the temperature range of -25 to 70°C	
Voltage influence			±2% max. of sensing distance within a range of ±10% of rated power supply voltage	
Insulation resistance			50 MΩ min. (at 500 VDC) between current-carrying parts and case	
Dielectric strength			500 VAC (50/60 Hz) for 1 min between current-carrying parts and case	2,000 VAC (50/60 Hz) for 1 min between current-carrying parts and case
Vibration resistance (destruction)			10 to 55 Hz, 1.5-mm double amplitude for 2 hours each in X, Y, and Z directions	
Shock resistance (destruction)			1,000m/s ² 10 times each in X, Y, and Z directions	
Degree of protection			IEC IP67	
Connection method			Pre-wired Models (Standard cable length: 1 m)	
Weight (packed state)			Approx. 1.4 kg	
Materials	Case		Die-cast aluminum	
	Sensing surface		Polyester	
Accessories			Instruction sheet	

* Full-wave rectified power supplies with a mean output of 24 VDC ±10% are available for the TL-LP50.

Engineering Data (Reference Value)

Sensing Area

TL-LP/LY

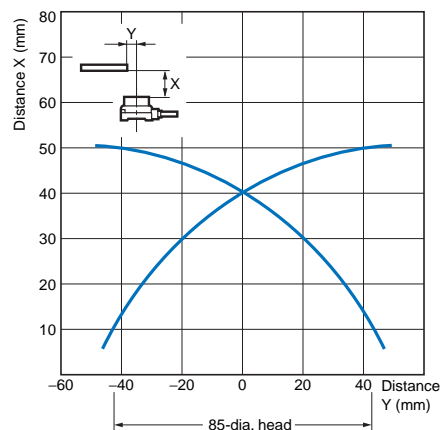

Leakage Current

TL-LY50

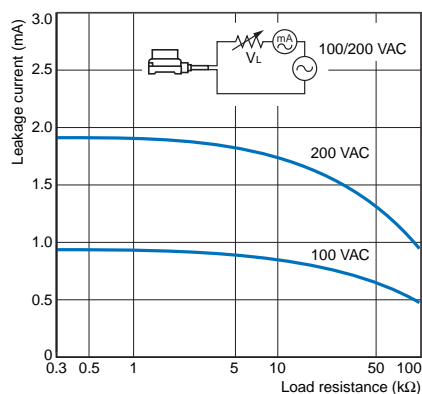

Residual Voltage

TL-LY50

at 100 VAC

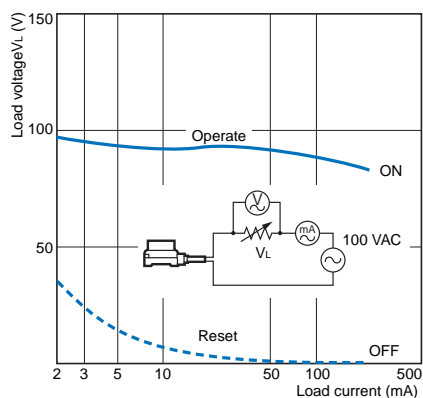

TL-LY50

at 200 VAC

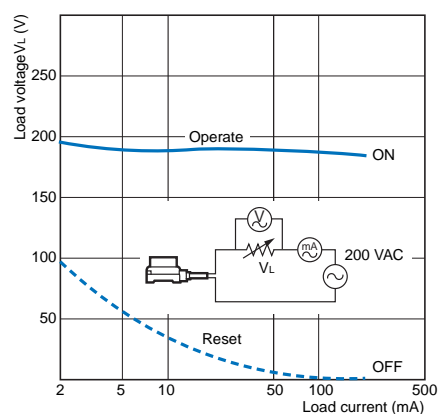

Sensing Object Size and Material vs. Sensing Distance

TL-LP/LY

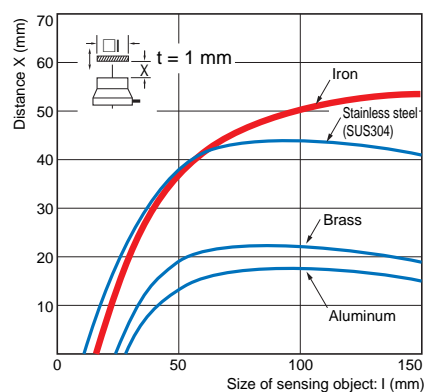

Column-type Sensing Object Diameter and Material vs. Sensing Distance

TL-LP/LY

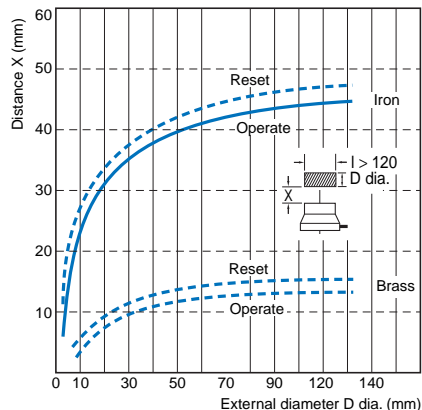

Sensing Object Thickness and Material vs. Sensing Distance

TL-LP/LY

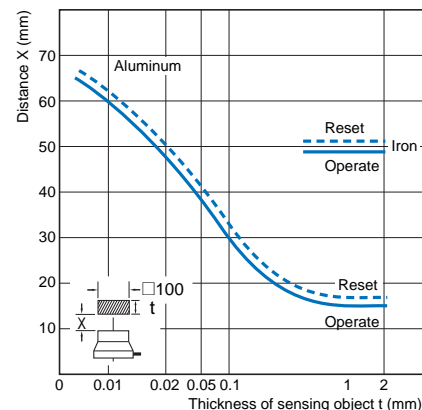

I/O Circuit Diagrams

3-wire DC Model

Output configuration	Model	Timing charts	Output circuit
NO	TL-LP50	<p>Sensing object Present (ON), Not present (OFF)</p> <p>Output transistor (Load) ON (ON), OFF (OFF)</p> <p>Operation indicator (red) ON (ON), OFF (OFF)</p>	

2-wire AC Model

Output configuration	Model	Timing charts	Output circuit
NO	TL-LY50	<p>Sensing object Present (ON), Not present (OFF)</p> <p>Load Operate (ON), Reset (OFF)</p> <p>Operation indicator (red) ON (ON), OFF (OFF)</p>	

Safety Precautions

WARNING

This product is not designed or rated for ensuring safety of persons. Do not use it for such purposes.

Precautions for Correct Use

Do not use this product under ambient conditions that exceed the ratings.

● Design

Effects of Surrounding Metal

Be sure to separate the Sensor from surrounding metal objects as shown in the following illustration.

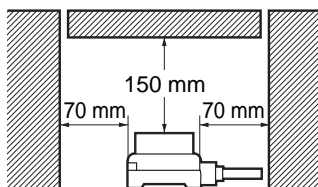

Mutual Interference

When two or more Sensors are mounted face-to-face or side-by-side, separate them as shown below.

Face-to-face Mounting

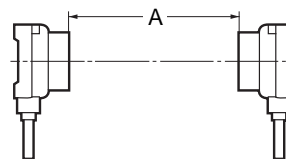

Parallel Mounting

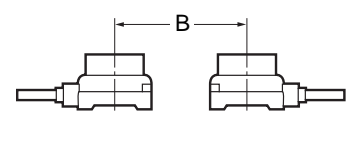

(Unit: mm)

Model	Distance	A	B
TL-L□50		1,000 (500)	700 (176)

Note: Figures in parentheses will apply if the Sensors in use are different from each other in response frequency.

Dimensions

Unless otherwise specified, the tolerance class IT16 is used for dimensions in this data sheet.

TL-LP50
TL-LY50

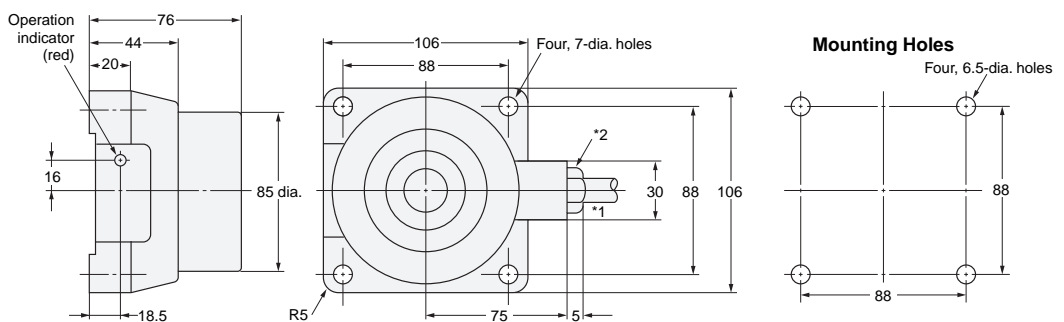
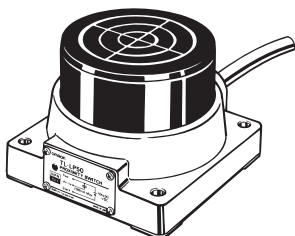

*1. Vinyl cabtire cable: TL-LP50: 9.4-dia. vinyl-insulated round cable with 3 conductors (Conductor cross section: 0.75 mm², Insulator diameter: 2.8 mm), Standard length: 1 m
TL-LY50: 9.0-dia. vinyl-insulated round cable with 2 conductors (Conductor cross section: 0.75 mm², Insulator diameter: 2.8 mm), Standard length: 1 m
*2. Remove the hexagon nut if a PF1/2 cable protective tube is applied.

In the interest of product improvement, specifications are subject to change without notice.

Terms and Conditions Agreement

Read and understand this catalog.

Please read and understand this catalog before purchasing the products. Please consult your OMRON representative if you have any questions or comments.

Warranties.

(a) Exclusive Warranty. Omron's exclusive warranty is that the Products will be free from defects in materials and workmanship for a period of twelve months from the date of sale by Omron (or such other period expressed in writing by Omron). Omron disclaims all other warranties, express or implied.

(b) Limitations. OMRON MAKES NO WARRANTY OR REPRESENTATION, EXPRESS OR IMPLIED, ABOUT NON-INFRINGEMENT, MERCHANTABILITY OR FITNESS FOR A PARTICULAR PURPOSE OF THE PRODUCTS. BUYER ACKNOWLEDGES THAT IT ALONE HAS DETERMINED THAT THE PRODUCTS WILL SUITABLY MEET THE REQUIREMENTS OF THEIR INTENDED USE.

Omron further disclaims all warranties and responsibility of any type for claims or expenses based on infringement by the Products or otherwise of any intellectual property right. (c) Buyer Remedy. Omron's sole obligation hereunder shall be, at Omron's election, to (i) replace (in the form originally shipped with Buyer responsible for labor charges for removal or replacement thereof) the non-complying Product, (ii) repair the non-complying Product, or (iii) repay or credit Buyer an amount equal to the purchase price of the non-complying Product; provided that in no event shall Omron be responsible for warranty, repair, indemnity or any other claims or expenses regarding the Products unless Omron's analysis confirms that the Products were properly handled, stored, installed and maintained and not subject to contamination, abuse, misuse or inappropriate modification. Return of any Products by Buyer must be approved in writing by Omron before shipment. Omron Companies shall not be liable for the suitability or unsuitability or the results from the use of Products in combination with any electrical or electronic components, circuits, system assemblies or any other materials or substances or environments. Any advice, recommendations or information given orally or in writing, are not to be construed as an amendment or addition to the above warranty.

See <http://www.omron.com/global/> or contact your Omron representative for published information.

Limitation on Liability: Etc.

OMRON COMPANIES SHALL NOT BE LIABLE FOR SPECIAL, INDIRECT, INCIDENTAL, OR CONSEQUENTIAL DAMAGES, LOSS OF PROFITS OR PRODUCTION OR COMMERCIAL LOSS IN ANY WAY CONNECTED WITH THE PRODUCTS, WHETHER SUCH CLAIM IS BASED IN CONTRACT, WARRANTY, NEGLIGENCE OR STRICT LIABILITY.

Further, in no event shall liability of Omron Companies exceed the individual price of the Product on which liability is asserted.

Suitability of Use.

Omron Companies shall not be responsible for conformity with any standards, codes or regulations which apply to the combination of the Product in the Buyer's application or use of the Product. At Buyer's request, Omron will provide applicable third party certification documents identifying ratings and limitations of use which apply to the Product. This information by itself is not sufficient for a complete determination of the suitability of the Product in combination with the end product, machine, system, or other application or use. Buyer shall be solely responsible for determining appropriateness of the particular Product with respect to Buyer's application, product or system. Buyer shall take application responsibility in all cases.

NEVER USE THE PRODUCT FOR AN APPLICATION INVOLVING SERIOUS RISK TO LIFE OR PROPERTY OR IN LARGE QUANTITIES WITHOUT ENSURING THAT THE SYSTEM AS A WHOLE HAS BEEN DESIGNED TO ADDRESS THE RISKS, AND THAT THE OMRON PRODUCT(S) IS PROPERLY RATED AND INSTALLED FOR THE INTENDED USE WITHIN THE OVERALL EQUIPMENT OR SYSTEM.

Programmable Products.

Omron Companies shall not be responsible for the user's programming of a programmable Product, or any consequence thereof.

Performance Data.

Data presented in Omron Company websites, catalogs and other materials is provided as a guide for the user in determining suitability and does not constitute a warranty. It may represent the result of Omron's test conditions, and the user must correlate it to actual application requirements. Actual performance is subject to the Omron's Warranty and Limitations of Liability.

Change in Specifications.

Product specifications and accessories may be changed at any time based on improvements and other reasons. It is our practice to change part numbers when published ratings or features are changed, or when significant construction changes are made. However, some specifications of the Product may be changed without any notice. When in doubt, special part numbers may be assigned to fix or establish key specifications for your application. Please consult with your Omron's representative at any time to confirm actual specifications of purchased Product.

Errors and Omissions.

Information presented by Omron Companies has been checked and is believed to be accurate; however, no responsibility is assumed for clerical, typographical or proofreading errors or omissions.