

Area Scanner F3ZN

Discrimination of a wide range of shapes makes this Scanner ideal for a variety of applications, such as sorting, inspection, and motion control.

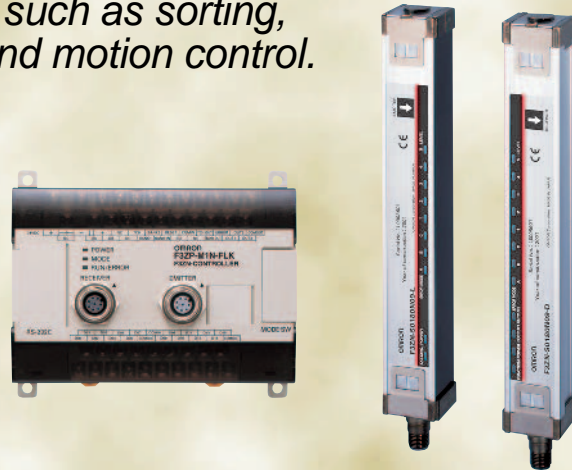

NEW CE

Refer to *Precautions* on page 13.

Features

Fits perfectly into installations!

Protective Height

The Scanner can be produced with a beam gap of 9, 15, 30, or 60 mm, and with a protective height of up to 1,785 mm.

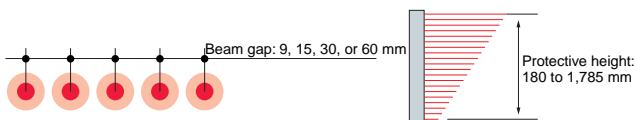

Connector

Two types of connector are available (side connection or bottom connection).

Connects in series for up to 240 beams.

Series Connection Specifications

Up to 3 Scanners can be connected in series to enable sensing with up to 240 beams.



* The response time varies with the length.

Support software for PCs allows functions to be set as desired with programmable I/O.

The statuses of the beams are output in parallel to allow height and area measurement as well as completeness checks.

- The total number of interrupted (or incident) beams can be output.
- Up to two types of status, such as the number of the highest (or lowest) beam that is interrupted (or incident), can be simultaneously output using 16 points of programmable I/O (P-I/O).

Beams can be handled in groups of a size selected by the user. Dropping position inspections and picking checks are possible.

	A	B	C	D
1	A1	B1	C1	D1
2	A2	B2	C2	D2
3	A3	B3	C3	D3
4	A4	B4	C4	D4

- Beams can be divided into as many as 16 groups.

Communications (RS-485/RS-232C) with PLCs (Programmable Controllers) are supported.

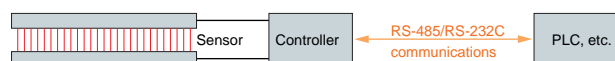

Applications

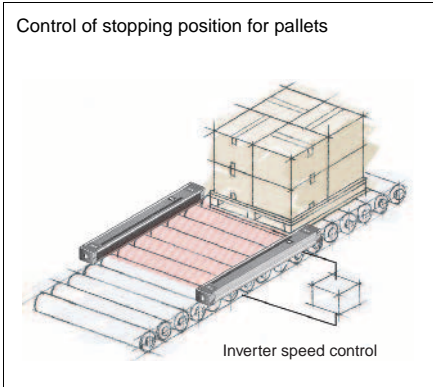
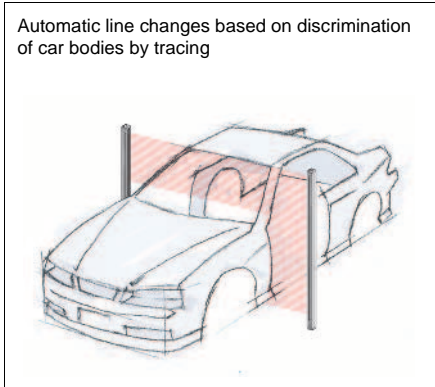
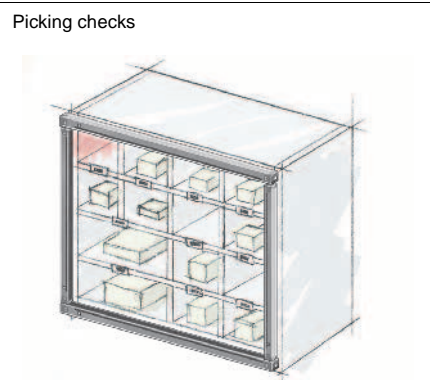
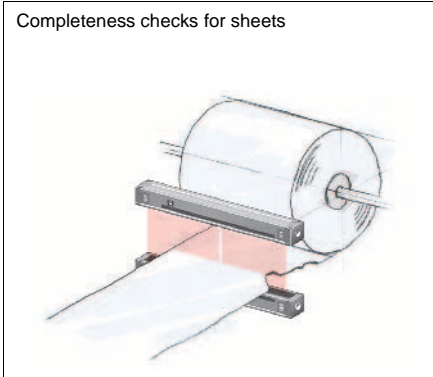
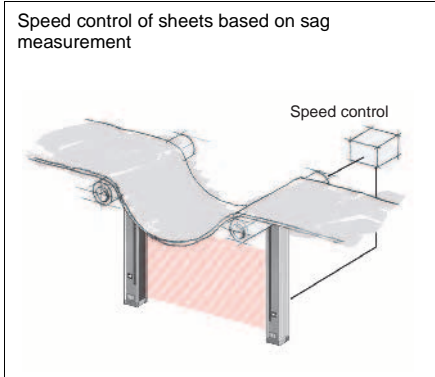
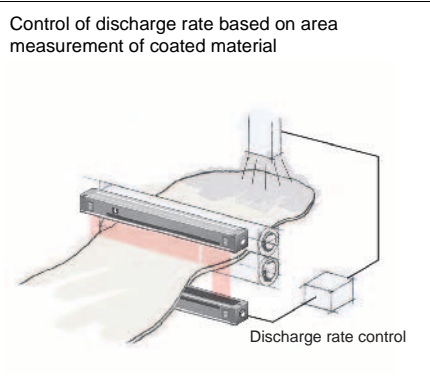

Features

Smarter and easier operation with PC control*, providing the optimum function for your needs.

* "Ascan" (for PCs) function setting support software required for PC integration.



Incident Level Monitoring

Conventional area sensors use ON/OFF control. The Area Scanner facilitates analog monitoring of the incident level and so installation and operating status checks and sensitivity adjustment can be performed simply. There are also features that allow smoother threshold setting.

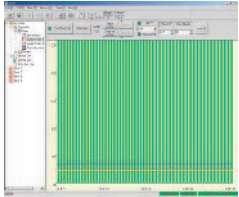

Scan Monitor

It is possible to keep track of ON/OFF data for all beams, together with times. This allows accurate object comparisons and checks based on a variety of settings.

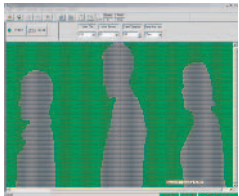

*The screen images shown here may differ from the actual product.

Programmable I/O can be allocated to various measurement processes.

- Measurements, such as the number of beams and the highest beam number, can be processed and the output format can be set (BCD/binary).

Point	Assignment	Format
D00	Invert disable Prohibit #1	On
D01	Invert disable Prohibit #1	On
D02	Invert disable Prohibit #1	On
D03	Invert disable Prohibit #1	On
D04	Invert disable Prohibit #1	On
D05	Invert disable Prohibit #1	On
D06	Invert disable Prohibit #1	On
D07	Invert disable Prohibit #1	On
D08	Invert disable Group1	Blocked beam
D09	Invert disable Group1	Blocked beam
D10	Invert disable Group1	Blocked beam
D11	Invert disable Group1	Blocked beam
D12	Invert disable Group1	Blocked beam
D13	Invert disable Group1	Blocked beam
D14	Invert disable Group1	Blocked beam
D15	Invert disable Simple ON/OFF	Blocked beam CH1

- Beams can be grouped.

- Measurement results can be freely allocated to 16 points of programmable I/O.

- Allocation and setting details can be displayed in list format. The information can also be printed or saved as data.



Main Functions of Ascan Ver. 2.10

Beam Level Graph

The light receiving sensitivity can be displayed as a graph. ON/OFF sensitivity adjustment is possible.

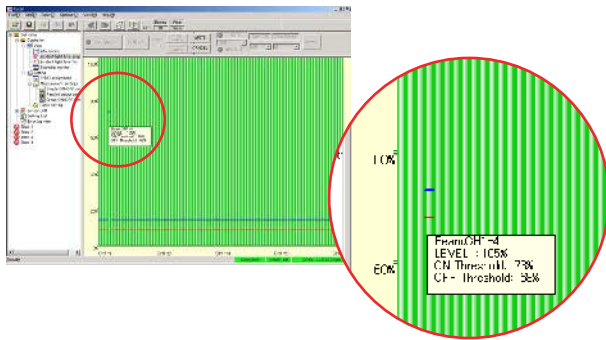

Combined ON/OFF Judgement

Output conditions based on the status of all the beams can be set as required (e.g., ON when 3 or more beams are incident, ON when 2 or more beams are interrupted, etc.)

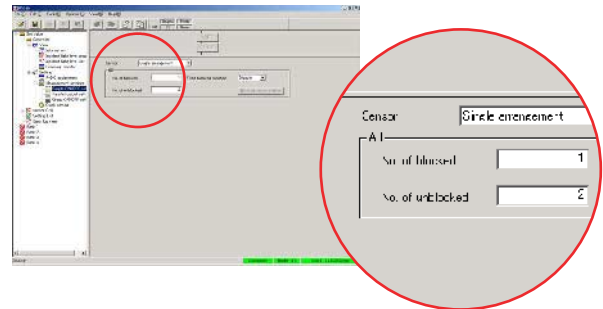

Beam Level List

The light receiving sensitivity can be displayed in digital figures and incident level data can be saved in files.

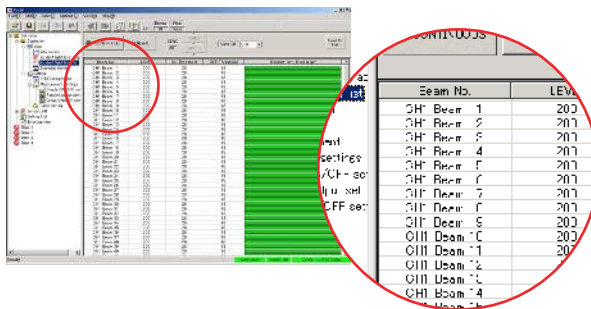

Parallel Output

The output format can be selected as required. For example, it is possible to output the number of the highest incident beam and the total number of interrupted beams.

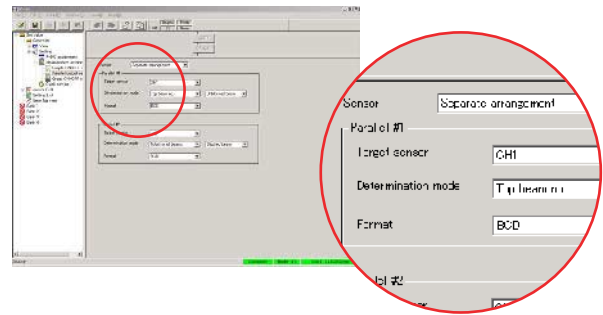

Scan Monitor

The ON/OFF status can be displayed at intervals of a user-set sampling time.

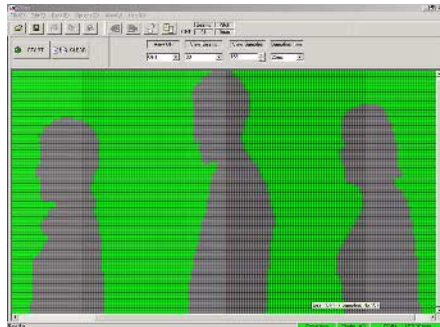

Group Judgement

Beams within an area can be handled as a group.

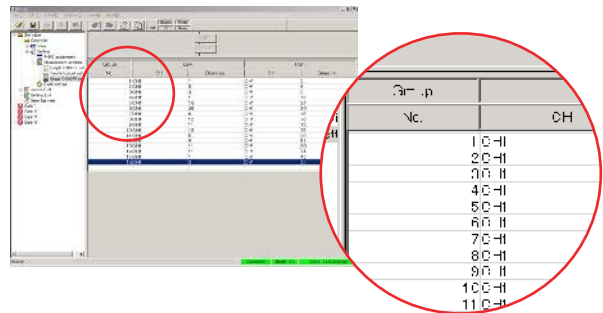

P-I/O (16 Points)

The conditions set for combined ON/OFF judgement, parallel output, and group judgement can be allocated to output as required.

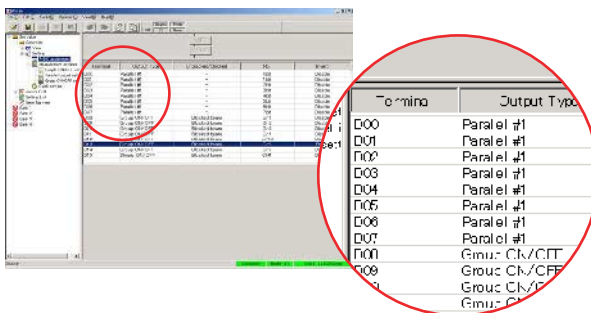

BANK Function

Four banks of settings are possible.

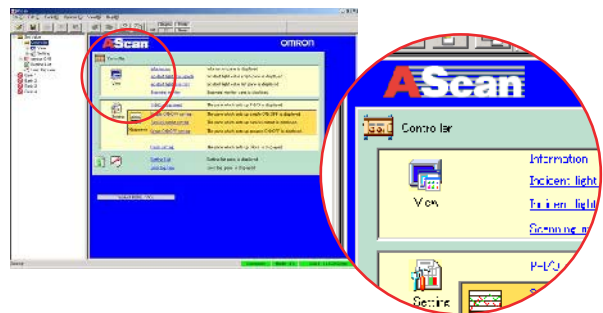



Available Models

Main Units

Sensor

 Infrared

Appearance	Operating range	Beam gap	Number of beams	Protective height	Model	
					PNP output	NPN output
	 0.2 to 7 m	9 mm	21 to 125 (See *1.)	180 to 1,116 mm	F3ZN-S□□□□P09	F3ZN-S□□□□N09
		15 mm	13 to 120	180 to 1,785 mm	F3ZN-S□□□□P15	F3ZN-S□□□□N15
	 0.2 to 10 m	30 mm	7 to 60	180 to 1,770 mm	F3ZN-S□□□□P30	F3ZN-S□□□□N30
		60 mm	4 to 30	240 to 1,740 mm	F3ZN-S□□□□P60	F3ZN-S□□□□N60

*1. Models with a 9-mm beam gap can only be produced for an odd number of beams.

*2. For details on model numbers, refer to *Recommended Area Scanner Models* on page 5.

Controller

Appearance	Output	Model
	PNP	F3ZP-M1P-FLK
	NPN	F3ZP-M1N-FLK

Accessories (Sold Separately)

Double-ended Connector Cable (Set of 2 for Emitter and Receiver)

Appearance	Cable length	Specification	Model	Application
	0.2 m	M12 connector (8 pins)	F39-JCR2B	Series connection or connection to the F3ZP-M1□-FLK
	3 m		F39-JC3B	
	7 m		F39-JC7B	Connection to the F3ZP-M1□-FLK
	10 m		F39-JC10B	
	15 m		F39-JC15B	

Area Scanner Function Setting Support Software (AScan)

Appearance	OS	Model
	Consult your OMRON representative.	(English version) F3ZP-CD100-E
		(Japanese version) F3ZP-CD100

Spatter Protection Cover

A Spatter Protection Cover, the F39-HN, is also available. Consult your OMRON representative for details.

Recommended Area Scanner Models



F3ZN-S□□□□N(P)09 and F3ZN-S□□□□N(P)09-01
(Beam gap: 9 mm)

Model	Protective height	Number of beams
F3ZN-S0180N(P)09(-01)	180 mm	21
F3ZN-S0288N(P)09(-01)	288 mm	33
F3ZN-S0432N(P)09(-01)	432 mm	49
F3ZN-S0576N(P)09(-01)	576 mm	65
F3ZN-S0720N(P)09(-01)	720 mm	81
F3ZN-S0864N(P)09(-01)	864 mm	97
F3ZN-S1008N(P)09(-01)	1,008 mm	113
F3ZN-S1116N(P)09(-01)	1,116 mm	125

F3ZN-S□□□□N(P)15 and F3ZN-S□□□□N(P)15-01
(Beam gap: 15 mm)

Model	Protective height	Number of beams
F3ZN-S0180N(P)15(-01)	180 mm	13
F3ZN-S0390N(P)15(-01)	390 mm	27
F3ZN-S0510N(P)15(-01)	510 mm	35
F3ZN-S0630N(P)15(-01)	630 mm	43
F3ZN-S0750N(P)15(-01)	750 mm	51
F3ZN-S0870N(P)15(-01)	870 mm	59
F3ZN-S0990N(P)15(-01)	990 mm	67
F3ZN-S1110N(P)15(-01)	1,110 mm	75
F3ZN-S1230N(P)15(-01)	1,230 mm	83
F3ZN-S1350N(P)15(-01)	1,350 mm	91
F3ZN-S1470N(P)15(-01)	1,470 mm	99
F3ZN-S1590N(P)15(-01)	1,590 mm	107
F3ZN-S1710N(P)15(-01)	1,710 mm	115
F3ZN-S1785N(P)15(-01)	1,785 mm	120

Connector Type

No extra figures at end of model number	-01 at end of model number
	
(Series connection type)	

F3ZN-S□□□□N(P)30 and F3ZN-S□□□□N(P)30-01
(Beam gap: 30 mm)





Appearance	Protective height	Number of beams
F3ZN-S0180N(P)30(-01)	180 mm	7
F3ZN-S0270N(P)30(-01)	270 mm	10
F3ZN-S0390N(P)30(-01)	390 mm	14
F3ZN-S0510N(P)30(-01)	510 mm	18
F3ZN-S0630N(P)30(-01)	630 mm	22
F3ZN-S0750N(P)30(-01)	750 mm	26
F3ZN-S0870N(P)30(-01)	870 mm	30
F3ZN-S0990N(P)30(-01)	990 mm	34
F3ZN-S1110N(P)30(-01)	1,110 mm	38
F3ZN-S1230N(P)30(-01)	1,230 mm	42
F3ZN-S1350N(P)30(-01)	1,350 mm	46
F3ZN-S1470N(P)30(-01)	1,470 mm	50
F3ZN-S1590N(P)30(-01)	1,590 mm	54
F3ZN-S1710N(P)30(-01)	1,710 mm	58
F3ZN-S1770N(P)30(-01)	1,770 mm	60

F3ZN-S□□□□N(P)60 and F3ZN-S□□□□N(P)60-01
(Beam gap: 60 mm)

Appearance	Protective height	Number of beams
F3ZN-S0240N(P)60(-01)	240 mm	5
F3ZN-S0300N(P)60(-01)	300 mm	6
F3ZN-S0420N(P)60(-01)	420 mm	8
F3ZN-S0540N(P)60(-01)	540 mm	10
F3ZN-S0660N(P)60(-01)	660 mm	12
F3ZN-S0780N(P)60(-01)	780 mm	14
F3ZN-S0900N(P)60(-01)	900 mm	16
F3ZN-S1020N(P)60(-01)	1,020 mm	18
F3ZN-S1140N(P)60(-01)	1,140 mm	20
F3ZN-S1260N(P)60(-01)	1,260 mm	22
F3ZN-S1380N(P)60(-01)	1,380 mm	24
F3ZN-S1500N(P)60(-01)	1,500 mm	26
F3ZN-S1620N(P)60(-01)	1,620 mm	28
F3ZN-S1740N(P)60(-01)	1,740 mm	30

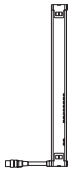
Customized Connectors

The types of connectors shown in the following table can also be produced.

-02 at end of model number	-03 at end of model number	-04 at end of model number	-05 at end of model number
			
(Series connection type)		(Series connection type)	(Series connection type)

Ratings and Performance

Main Units

Common Ratings and Performance Data for F3ZN-S□□□□P□□(-01 to -05) Sensors

Item	Model	F3ZN-S□□□□P09	F3ZN-S□□□□P15	F3ZN-S□□□□P30	F3ZN-S□□□□P60
Operating range		0.2 to 7 m		0.2 to 10 m	
Beam gap		9 mm	15 mm	30 mm	60 mm
Number of beams		21 to 125	13 to 120	7 to 60	4 to 30
Protective height		180 to 1,116 mm	180 to 1,785 mm	180 to 1,770 mm	240 to 1,740 mm
Minimum detectable object size (non-transparent)		14 mm in diameter	25 mm in diameter	40 mm in diameter	70 mm in diameter
Light source (wavelength)		Infrared LED (870 nm)			
Supply voltage		24 VDC ±10%; ripple (p-p): 10% max.			
Current consumption (under no-load conditions)		Emitter: 170 mA max.; Receiver: 120 mA max.			
Control output		PNP:PNP transistor output (load current: 50 mA) Output 1: Light ON Output 2: Dark ON (default)			
External diagnosis input		Open or 0 to 1.5 VDC: inactive (emitting) 9 to 24 VDC: active (emitting OFF), short-circuit current is 3 mA max.			
Indicators	Emitter	Incident level indicators (green): 5 LED indicators that turn ON/OFF according to the amount of incident light. Error indicators (red): 3 LED indicators that turn ON/OFF according to the type of errors that occur. Power indicator (green): Turns ON for normal operation; flashes when errors occur. External diagnosis indicator (orange): Turns ON in response to external diagnosis input.			
	Receiver	Incident level indicators (green): 5 LED indicators that turn ON/OFF according to the amount of incident light. Error indicators (red): 3 LED indicators that turn ON/OFF according to the type of errors that occur. Control output 1 operation indicator (orange): Turns ON when light is incident. Control output 2 operation indicator (orange): Turns ON when light is interrupted (factory setting). Power indicator (green): Turns ON for normal operation; flashes when errors occur. Function indicator (green): Turns ON when option is set.			
Protection		Reverse polarity protection (for power supply) and output short-circuit protection			
Response time		Refer to page 9 for details.			
Ambient light intensity		Light intensity on the receiver surface: Incandescent lamp: 3,000 lx max. Sunlight: 10,000 lx max.			
Ambient temperature		Operating: -10 to 55 °C; Storage: -30 to 70 °C (with no icing or condensation)			
Ambient humidity		Operating/storage: 30% to 95% (with no condensation)			
Insulation resistance		20 MΩ min. (at 500 VDC)			
Dielectric strength		1,000 VAC, 50/60 Hz for 1 min			
Vibration resistance (malfunction)		10 to 55 Hz with a 0.7-mm double amplitude, 20 sweeps each in X, Y, and Z directions			
Shock resistance (malfunction)		100m/s ² , 1,000 times each in X, Y, and Z directions			
Degree of protection		IP65 (IEC)			
Connection method		M12 connector			
Weight (in packaging)		(Protective height + 100) × 2 + 2,100 g			
Materials	Case	Aluminum			
	Front cover	Acrylic (PMMA resin)			
	Cable	Oil-resistant PVC			
Accessories		Top, bottom, and intermediate* mounting brackets, and instruction manual			

* Intermediate mounting brackets are supplied only with the following models:
Models with a total length between 640 and 1,280 mm: One set (i.e., one each for emitter and receiver)
Models with a total length greater than 1,280 mm: Two sets (i.e., two each for emitter and receiver)

Main Units

Common Ratings and Performance Data for F3ZN-S□□□□N□□(-01 to -05) Sensors

Item	Model	F3ZN-S□□□□N09	F3ZN-S□□□□N15	F3ZN-S□□□□N30	F3ZN-S□□□□N60
Operating range		0.2 to 7 m		0.2 to 10 m	
Beam gap		9 mm	15 mm	30 mm	60 mm
Number of beams		21 to 125	13 to 120	7 to 60	4 to 30
Protective height		180 to 1,116 mm	180 to 1,785 mm	180 to 1,770 mm	240 to 1,740 mm
Minimum detectable object size (non-transparent)		14 mm in diameter	25 mm in diameter	40 mm in diameter	70 mm in diameter
Light source (wavelength)		Infrared LED (870 nm)			
Supply voltage		24 VDC ±10%; ripple (p-p): 10% max.			
Current consumption (under no-load conditions)		Emitter: 170 mA max.; Receiver: 120 mA max.			
Control output		NPN:NPN transistor output (load current: 50 mA) Output 1: Light ON Output 2: Dark ON (default)			
External diagnosis input		Open or 9 to 24 VDC: inactive (emitting) 0 to 1.5 VDC: active (emitting OFF), short-circuit current is 3 mA max.			
Indicators	Emitter	Incident level indicators (green): 5 LED indicators that turn ON/OFF according to the amount of incident light. Error indicators (red): 3 LED indicators that turn ON/OFF according to the type of errors that occur. Power indicator (green): Turns ON for normal operation; flashes when errors occur. External diagnosis indicator (orange): Turns ON in response to external diagnosis input.			
	Receiver	Incident level indicators (green): 5 LED indicators that turn ON/OFF according to the amount of incident light. Error indicators (red): 3 LED indicators that turn ON/OFF according to the type of errors that occur. Control output 1 operation indicator (orange): Turns ON when light is incident. Control output 2 operation indicator (orange): Turns ON when light is interrupted (factory setting). Power indicator (green): Turns ON for normal operation; flashes when errors occur. Function indicator (green): Turns ON when option is set.			
Protection		Reverse polarity protection (for power supply) and output short-circuit protection			
Response time		Refer to page 9 for details.			
Ambient light intensity		Light intensity on the receiver surface: Incandescent lamp: 3,000 lx max. Sunlight: 10,000 lx max.			
Ambient temperature		Operating: -10 to 55 °C; Storage: -30 to 70 °C (with no icing or condensation)			
Ambient humidity		Operating/storage: 30% to 95% (with no condensation)			
Insulation resistance		20 MΩ min. (at 500 VDC)			
Dielectric strength		1,000 VAC, 50/60 Hz for 1 min			
Vibration resistance (malfunction)		10 to 55 Hz with a 0.7-mm double amplitude, 20 sweeps each in X, Y, and Z directions			
Shock resistance (malfunction)		100m/s ² , 1,000 times each in X, Y, and Z directions			
Degree of protection		IP65 (IEC)			
Connection method		M12 connector			
Weight (in packaging)		(Protective height + 100) × 2 + 2,100 g			
Materials	Case	Aluminum			
	Front cover	Acrylic (PMMA resin)			
	Cable	Oil-resistant PVC			
Accessories		Top, bottom, and intermediate* mounting brackets, and instruction manual			

* Intermediate mounting brackets are supplied only with the following models:
Models with a total length between 640 and 1,280 mm: One set (i.e., one each for emitter and receiver)
Models with a total length greater than 1,280 mm: Two sets (i.e., two each for emitter and receiver)

Ratings and Performance

Main Units Controller

Item	Model	F3ZP-M1N-FLK	F3ZP-M1P-FLK
Supply voltage		24 VDC ±10%; ripple (p-p): 10% max.	
Current consumption		50 mA max. (not including the Sensor's current consumption and output current)	
Connectable Sensors		F3ZN-S□□□□N□□	F3ZN-S□□□□P□□
Number of connectable Sensors		3 sets of Sensors and Sensor configurations with 240 beams.	
Output (OUT1, OUT2, OUTPUT (OUT3, ERROR, BANK OUT, TCH OUT))		Load supply voltage: 24 VDC max.; NPN open collector output (load current: 50 mA max.)	Load supply voltage: 24 VDC max.; PNP open collector output (load current: 30 mA max.)
Input (TCH, EDI, RESET, BANKIN, BANK1, BANK2)		DC input: Maximum input voltage: 24 V ±10% Operating voltage: ON voltage: 9 V min.; OFF voltage: 1.5 V max. Input current: 3 mA max.	
Program mable I/O ports (D00 to D15)	Output	The purpose depends on the application.	
		Load supply voltage: 24 VDC max.	
	Input	NPN open collector output (load current: 50 mA max.)	PNP open collector output (load current: 30 mA max.)
		DC input; Input voltage: 24 V ±10%; Input current: 3 mA max.	
Operating voltage	ON voltage: 9 V min. OFF voltage: 1.5 V max.	ON voltage: 1.5 V max. OFF voltage: 9 V min.	
Communi-cations functions	Communications ports	RS-232 port (D-sub 9-pin connector) and RS-485 port (terminal block) (Selected with a selector.)	
	Communications protocol	CompoWay/F	
	Unit numbers	00 to 15 (Set with rotary switch.)	
	Baud rate	9,600, 14,400, 19,200, 38,400, 57,600, or 115,200 bps (Selected with switch.)	
	Data configuration	Data bits: 7; Parity: Even; Start bits: 1; Stop bits: 2; No flow control	
Clock function		Year, month, day, hour, minute, second, and day of week	
Indicators		POWER (green), MODE (green), RUN (green), and ERROR (red)	
Protection		Reverse polarity protection (for power supply) and output short-circuit protection	
Response time		Refer to page 9 for details.	
Ambient temperature		Operating: -10 to 55 °C; Storage: -20 to 75 °C (with no icing or condensation)	
Ambient humidity		Operating/storage: 10% to 90% (with no condensation)	
Insulation resistance		20 MΩ min. (at 500 VDC) between all terminals and the case	
Dielectric strength		1,000 VAC, 50/60 Hz for 1 min; Leakage current: 10 mA max.	
Vibration resistance (destruction)		Conforms to IEC 60068-6 10 to 57 Hz with 0.075-mm double amplitude and 57 to 150 Hz with acceleration of 9.8 m/s ² for 80 min each in X, Y, and Z directions (10 sweeps × 8 min per sweep = 80 min)	
Shock resistance (destruction)		Conforms to IEC 60068-27 147 m/s ² , 3 times each in X, Y, and Z directions	
Structure		Built into panel	
Accessories		RS-232C connector (plug, cover) and instruction manual	

Response Times

Detection Output Response Times

The response times vary with the length (protective height) of the Sensor.

Model		Protective height (mm)			
F3ZN-S□□□□N(P)09 (-01 to -05)		0180 to 0441	0450 to 0756	0765 to 1071	1080 to 1116
F3ZN-S□□□□N(P)15/30/60		0180 to 0735	0750 to 1260	1275 to 1785	---
Control output 1	ON→OFF	11 ms	13.5 ms	16 ms	16.5 ms
	OFF→ON	44 ms	54 ms	64 ms	66 ms
Control outputs 2 and 3	ON→OFF	22 ms	27 ms	32 ms	33 ms
	OFF→ON	55 ms	67.5 ms	80 ms	82.5 ms
Programmable I/O (D00 to D15)		33 ms	40.5 ms	48 ms	49.5 ms

Note: The response times for control outputs 2 and 3 given in the above table are for when the output is set to "Light-ON" (i.e., ON if the beam is incident), which is the same setting as control output 1.

Timing Chart for the Period between Workpiece Detection and Output Response

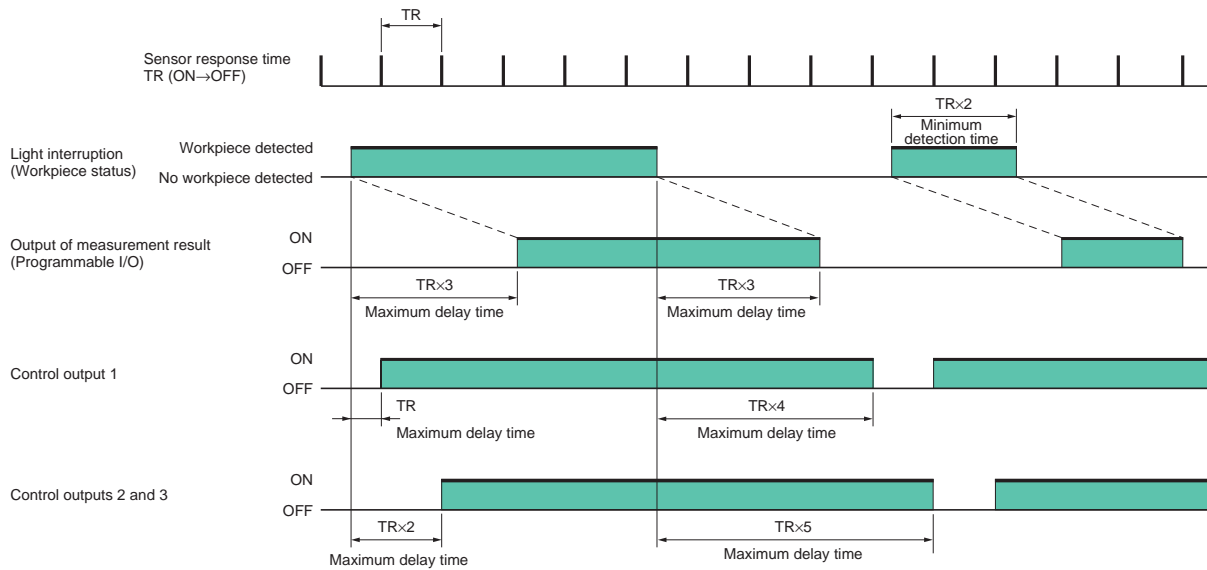

TR: Response time of control output 1 (ON→OFF). (Refer to Detection Output Response Times.)

Minimum detection time: The minimum time in which changes in the interrupted (or incident) state can be detected.

- Minimum detection time for programmable I/O** = $TR \times 2$
- Minimum detection time for control outputs 1, 2, and 3 (interrupted)** = TR
- Minimum detection time for control outputs 1, 2, and 3 (incident)** = $TR \times 3$

Maximum delay time (maximum response time): The maximum time between light interruption (or incidence) and the resulting change in output.

- Maximum delay time for programmable I/O output (D00 to D15)** = $TR \times 3$
- Maximum delay time for control output 1 (interrupted)** = TR
- Maximum delay time for control output 1 (incident)** = $TR \times 4$
- Maximum delay time for control outputs 2 and 3 (interrupted)** = $TR \times 2$
- Maximum delay time for control outputs 2 and 3 (incident)** = $TR \times 5$

Note: Consult your OMRON representative for details on response times when the Sensors are connected in series.

I/O Block Circuit Diagram

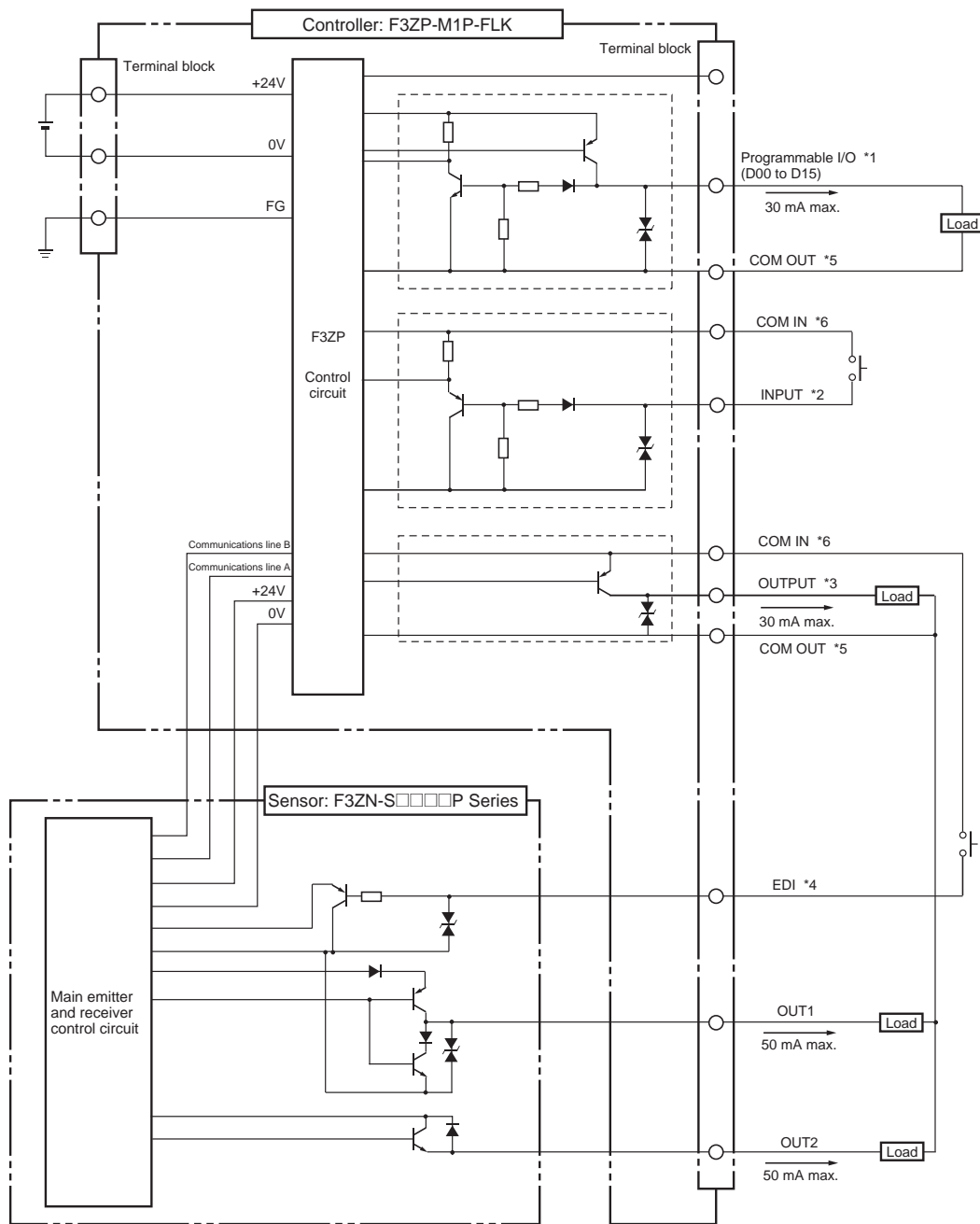

Timing Chart for External Diagnosis Function (Stable Incidence)

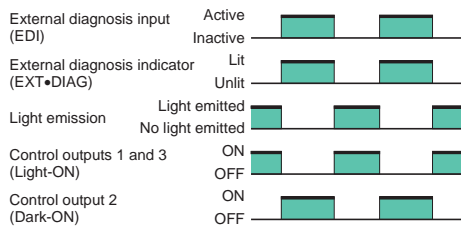

- *1. INPUT is used for RESET and TCH.
- *2. OUTPUT is used for OUT3, ERROR, and TCH OUT.
- *3. EDI is external diagnosis input.
- *4. COM OUT is connected to +24V.
- *5. COM IN is connected to 0V.

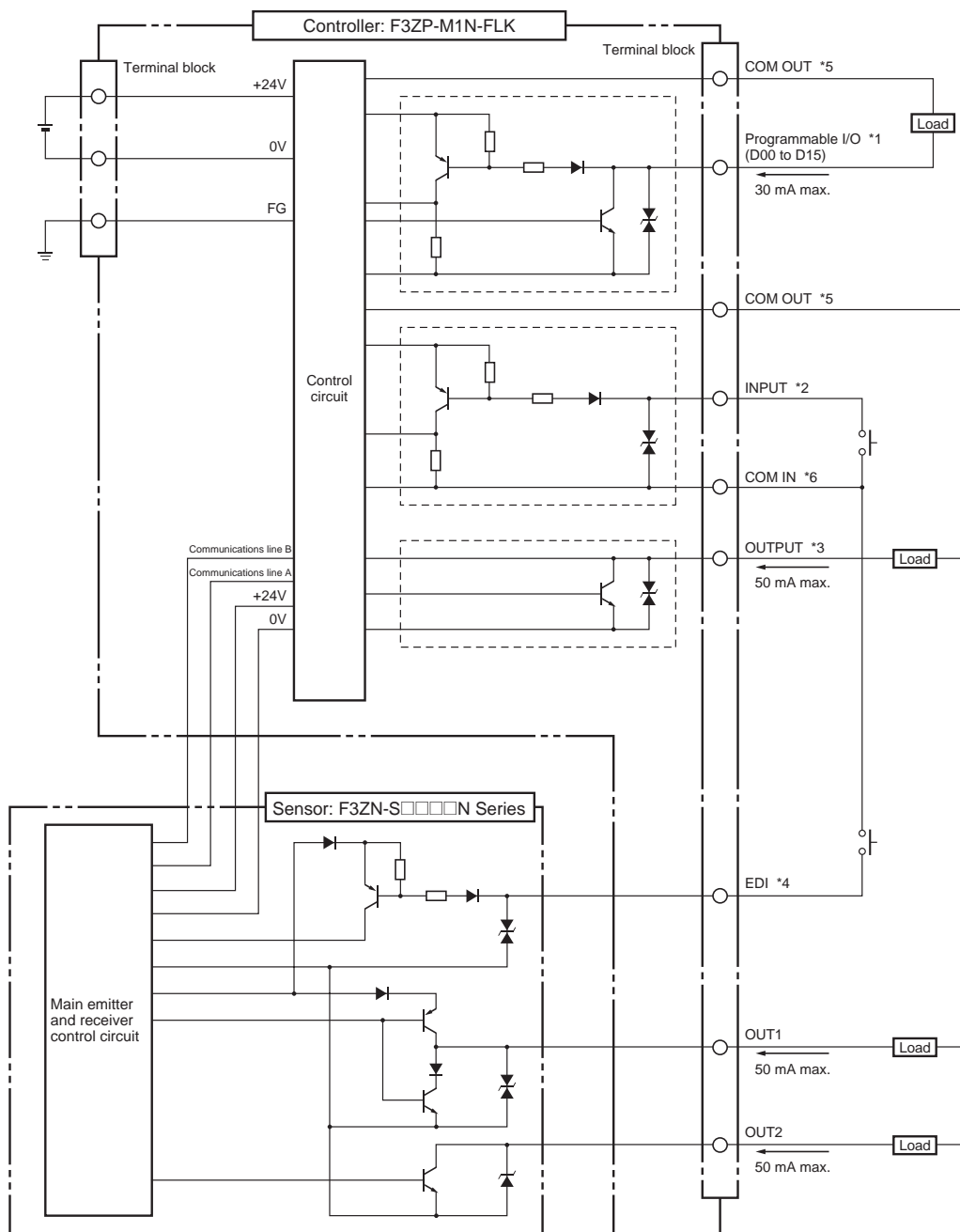

Timing Chart for External Diagnosis Function (Stable Incidence)

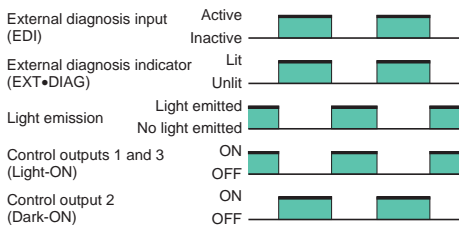

- *6. INPUT is used for RESET and TCH.
- *7. OUTPUT is used for OUT3, ERROR, and TCH OUT.
- *8. EDI is external diagnosis input.
- *9. COM OUT is connected to +24V.
- *10. COM IN is connected to 0V.

Controller Communications Settings

Mode Selection Switch

If necessary, make changes to the communications settings using the mode selection switch. The baud rate is factory-set to 9,600 bps and the unit number is factory-set to 1.

Unit number selection switch
(Unit number: Rotary switch number)

Baud rate selection pins
(Baud rate: Pins 1, 2, and 3 of the DIP switch)

Pin number			Baud rate
1	2	3	
OFF	OFF	OFF	9,600 bps
ON	OFF	OFF	14,400 bps
OFF	ON	OFF	19,200 bps
ON	ON	OFF	38,400 bps
OFF	OFF	ON	57,600 bps
ON	OFF	ON	115,200 bps

Baud rate selection pin
(Communications port: Pin 4 of the DIP switch)

Pin 4	Communications port
OFF	RS-232C
ON	RS-485

Be sure to set pin 9 of the DIP switch to OFF.

This is the termination setting for RS-485 communications. Set to ON if used as the termination point (normally OFF).

Engineering Data (Typical Examples)

Parallel Operating Range

F3ZN-S□□□□N(P)09(-01)

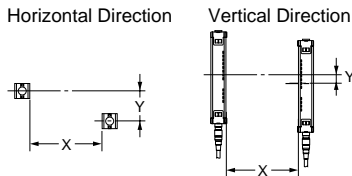
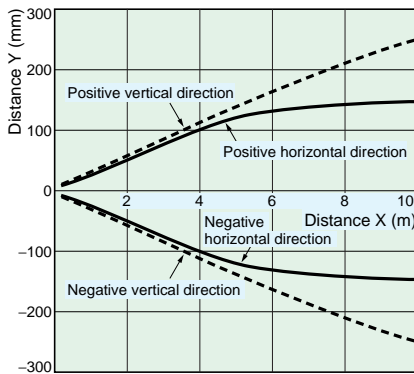

Angular Range (Angle of Elevation)

F3ZN-S□□□□N(P)09(-01)

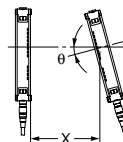
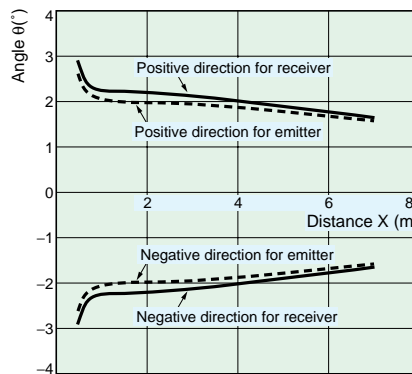

Angular Range (Angle of Rotation)

F3ZN-S□□□□N(P)09(-01)

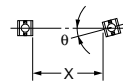
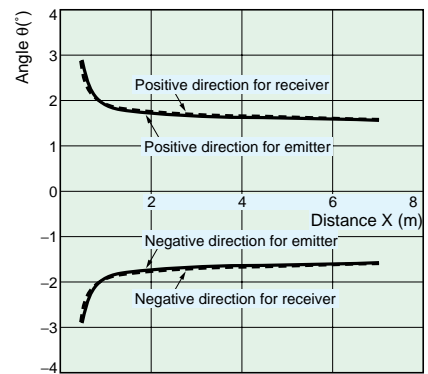

Precautions

Refer to SAOO-201A-E1-S on page TSB-28.

WARNING

Do not use the Scanner as a safety device in pressing machines or as a safety device for protecting the human body in any other kind of installation.



- (1) Do not use the Scanner in environments where flammable or explosive gases are present.
- (2) The Scanner cannot be used as a safety device for protecting the operator's hands or any other part of the body in pressing machines, shears, rolling machines, spinning machines, cotton mill machines, or robots.
- (3) This product is designed for applications such as detecting the entrance of human bodies into the operator area and detecting moving objects. It is not designed for use as a safety device.
- (4) If this product is used in exported equipment in any of the ways 1) to 4) listed below, OMRON shall accept no responsibility for any problems concerning local law or product liability.
 - 1) Application as a safety device for preventing injury resulting from the operator's hands or any other part of the body entering a dangerous area
 - 2) Application in interlocks in machinery or installations
 - 3) Application as a safety device that detects the presence of the operator's hands or any other part of the body in a dangerous area and stops the machinery or installation in which it is incorporated
 - 4) Application as a sensing device in installations for preventing access to dangerous areas by detecting the operator's hands or any other part of the body, and opening/closing a window or door

Caution

When using more than one Scanner installed close together, in order to prevent malfunctions due to mutual interference, be sure to observe the points mentioned under *Preventing Mutual Interference* on page 13.

Application Precautions

In order to ensure safety, be sure to observe the points described below.

• **Wiring**

Operating Environment

- Do not attempt to disassemble, repair, or modify the product.
- Be sure to turn OFF power to the system before installing or replacing the product.

Correct Use

• **Designing the System**

Operation at Power-ON

After turning ON the power, one second must elapse before the Sensor can perform sensing. Therefore, do not use other related devices until at least one second has elapsed after turning the power ON. If the load and the Sensor are connected to different power supplies, be sure to turn ON the power to the Sensor first.

Preventing Mutual Interference

- When using more than one Sensor installed close together, separate them by the distances l_1 or l_2 (at least 1.5 times the distances shown under *Parallel Operating Range* on page 12) in the way shown below.

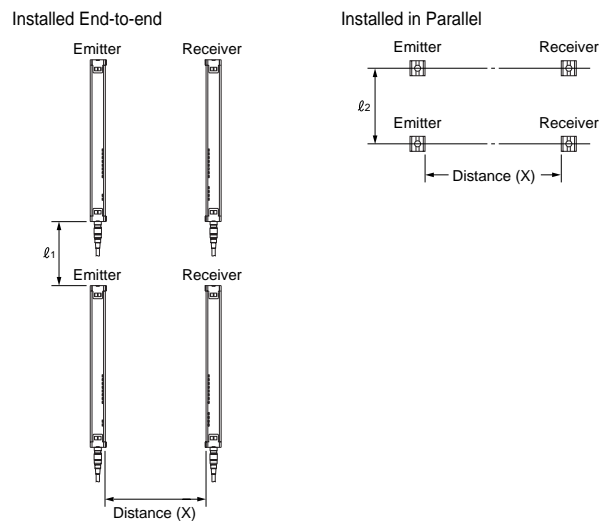

- Install baffles to block out light from other emitters. (See Fig. 1.)

In addition to direct light, light may also be reflected off walls, the floor, and other surfaces. Install the baffles so that all light from other emitters, including reflected light, is blocked. (See Fig. 2.)

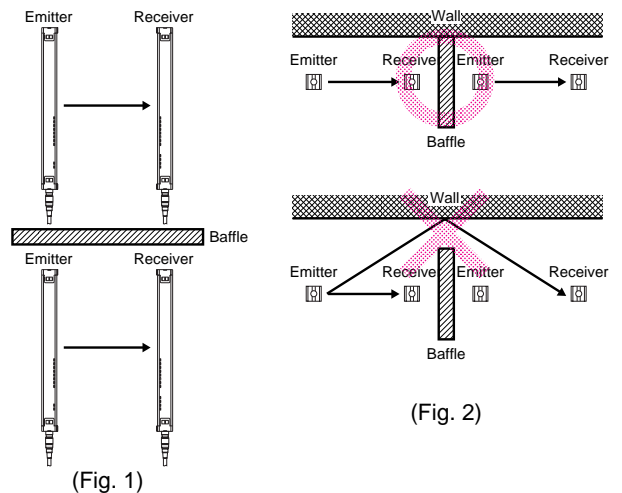

• **Wiring**

Connection

- To extend the connection distance, use lines with a cross-sectional area of at least 0.3 mm², and do not extend to a distance exceeding 100 m. Use a shielded cable, and connect the shield line to the 0-V line.
- Incorrect wiring may result in damage to devices. Ensure that connectors and cables do not come loose by giving careful consideration to the cable length and installation arrangement.

Cables

In configurations where the cable must be bent, allow at least the dimensions shown below. (Cable's minimum bending radius: 36 mm.)

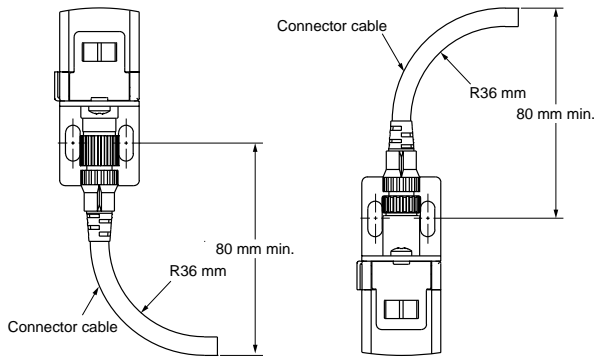

• **Installation**

Installation Precautions

- Install the Sensor so that no beams of strong light, such as sunlight, fluorescent light, or incandescent light can enter at an angle less than the effective aperture angle of the Sensor.
- Do not strike the Sensor with a hammer during installation. Doing so may damage the internal structure.
- Install the Sensor so that the cables on the emitter and receiver point in the same direction. (See below.)

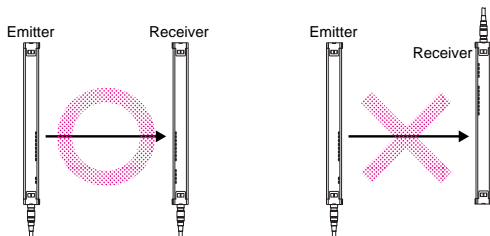

- Secure the Controller using M4 screws.
- Secure the case using a tightening torque of 1.2 N·m max.

Reflection off Walls and Floors

If the Sensor is installed in the way shown below, the beam may not be blocked properly due to the reflection of light off the floor. The same problem can also occur with light reflected off walls. Check that the sensing object can be detected properly before starting actual operation.

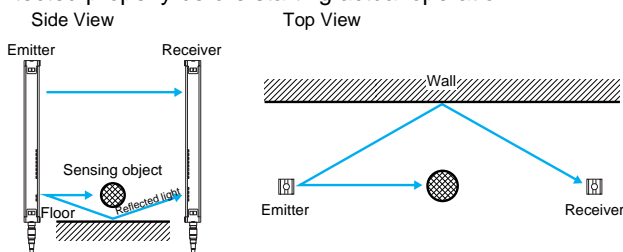

• **Adjustment**

Operation/Stability Indicators

- The indicators operate according to the incident level in the way shown below.
- Set the Scanner so that all the incident level indicators are lit.

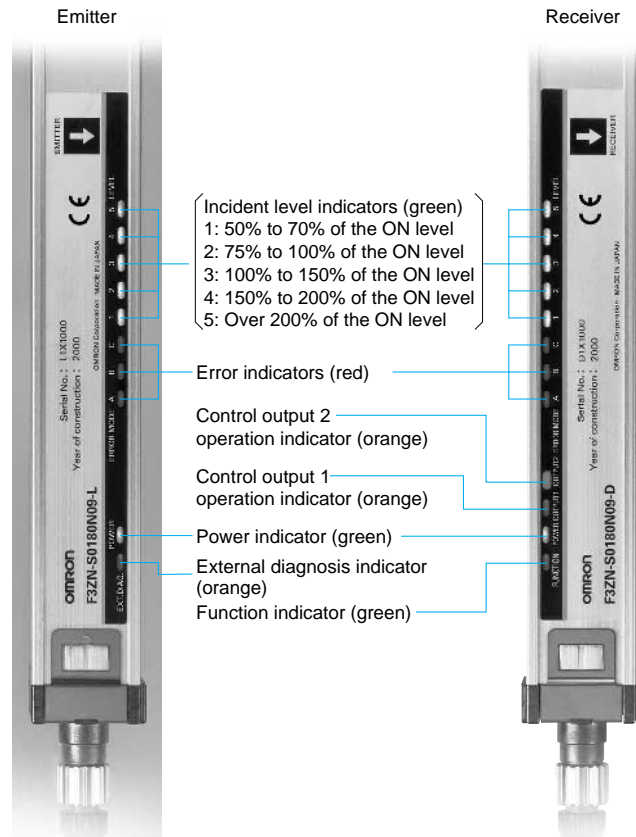

Note: The Sensor's ON/OFF indication and the Controller's ON/OFF status may vary, depending on the settings made by the user.

Dimensions

(Units: mm)

Main Units

Sensor

- F3ZN-S□□□□N(P)□□
- F3ZN-S□□□□N(P)□□-01 (-03, -05)
- F3ZN-S□□□□N(P)□□-02 (-03, -04, -05)

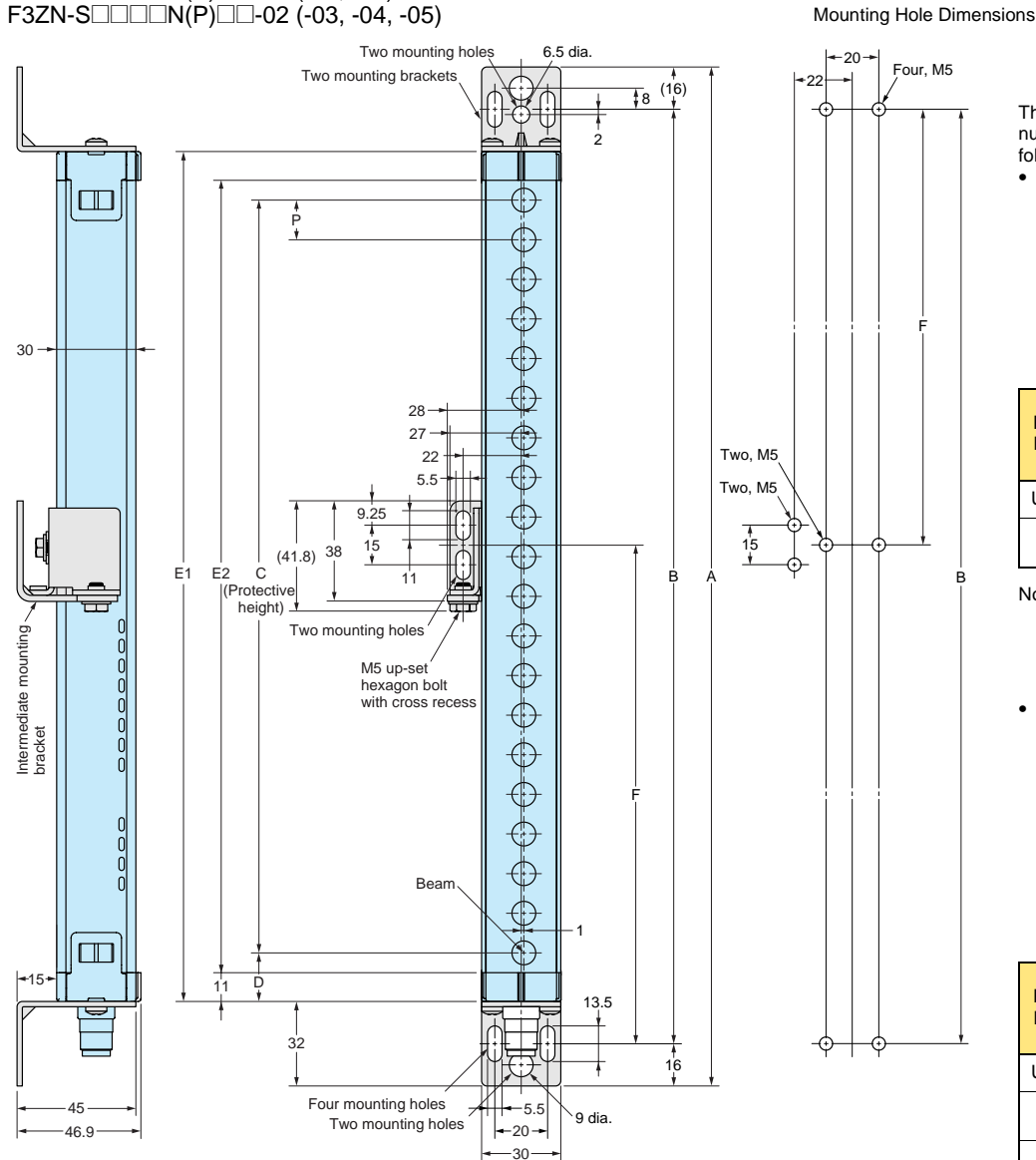

The dimensions for different model numbers can be calculated using the following formulae.

- F3ZN-S□□□□N(P)09
 - Dimension C (protective height) = The 4 digits in the model number
 - Dimension A = C + 95
 - Dimension B = C + 63
 - Dimension D = 15.5
 - Dimension E1 = C + 31
 - Dimension E2 = C + 9
 - Dimension F = See table below.
 - Dimension P = 9

Protective height (C)	Number of intermediate mounting brackets	Dimension F (See note.)
Up to 611	0	---
612 to 1,116	1	F = B/2

Note: When not using the value of F obtained with the above calculation, use a value not exceeding 670 mm.

- F3ZN-S□□□□N(P)15, F3ZN-S□□□□N(P)30, or F3ZN-S□□□□N(P)60
 - Dimension C (protective height) = The 4 digits in the model number
 - Dimension A = C + 101
 - Dimension B = C + 69
 - Dimension D = 18.5
 - Dimension E1 = C + 37
 - Dimension E2 = C + 15
 - Dimension F = See table below.
 - Dimension P = 15

Protective height (C)	Number of intermediate mounting brackets	Dimension F (See note.)
Up to 611	0	---
612 to 1,230	1	F = B/2
1,231 to 1,785	2	F = B/3

Note: When not using the value of F obtained with the above calculation, use a value not exceeding 670 mm.

Note: In the above diagram, the intermediate mounting bracket (refer to page 17) is shown mounted on the left as an example. If the intermediate mounting bracket is mounted on the right, the mounting holes must also be on the right.

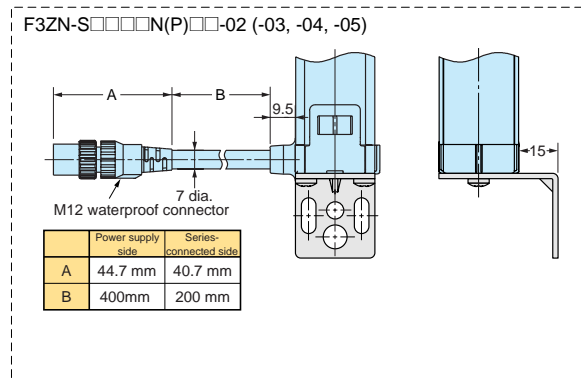
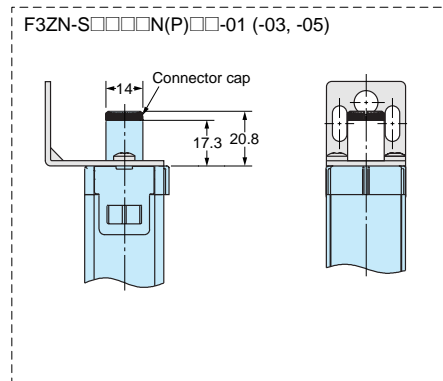

* Consult your OMRON representative for other dimension diagrams.

Controller
 F3ZP-M1N-FLK
 F3ZP-M1P-FLK

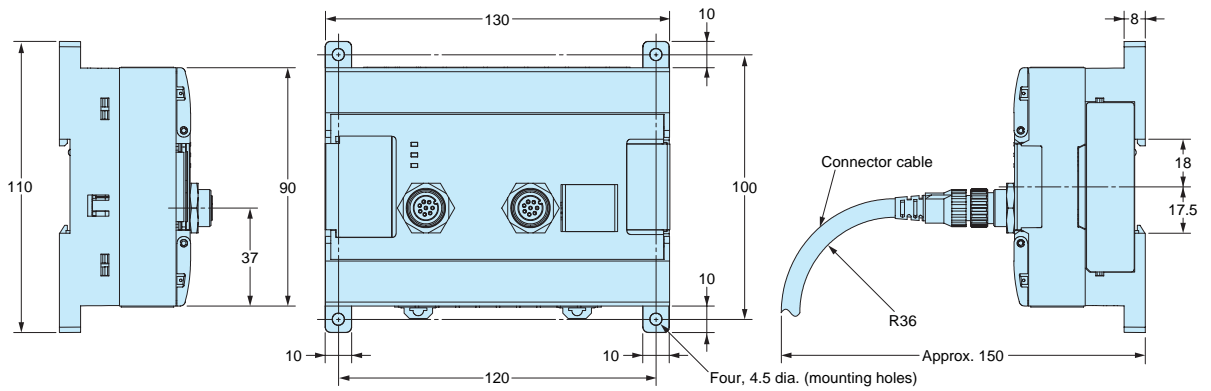
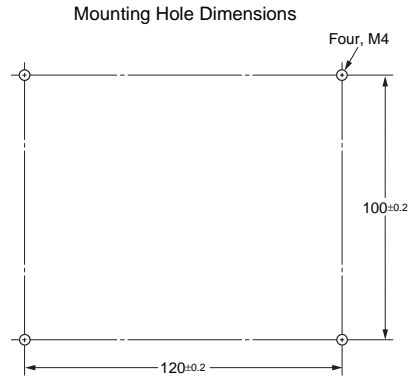
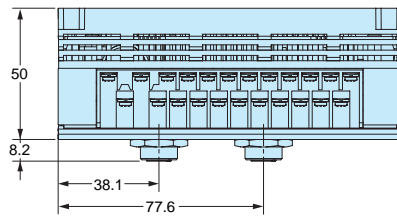
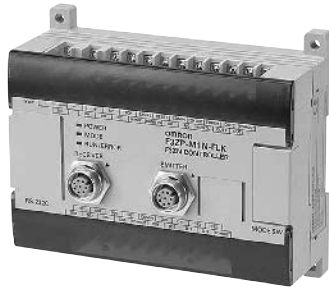

Accessories

Top and Bottom Mounting Brackets

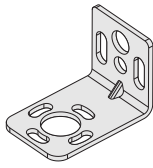

Material: Iron

Note: Provided with the product.

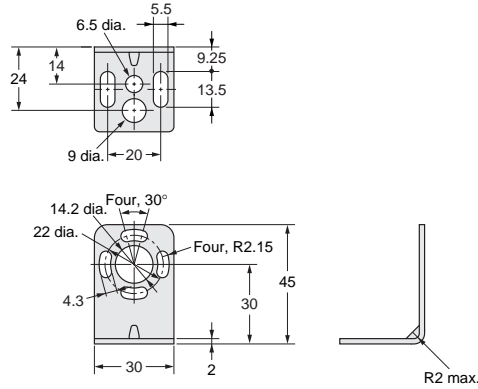

Intermediate Mounting Bracket

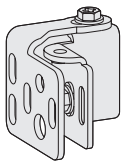

Material: Iron

Note: Provided with the product. The number of brackets required depends on the total length of the Sensor.

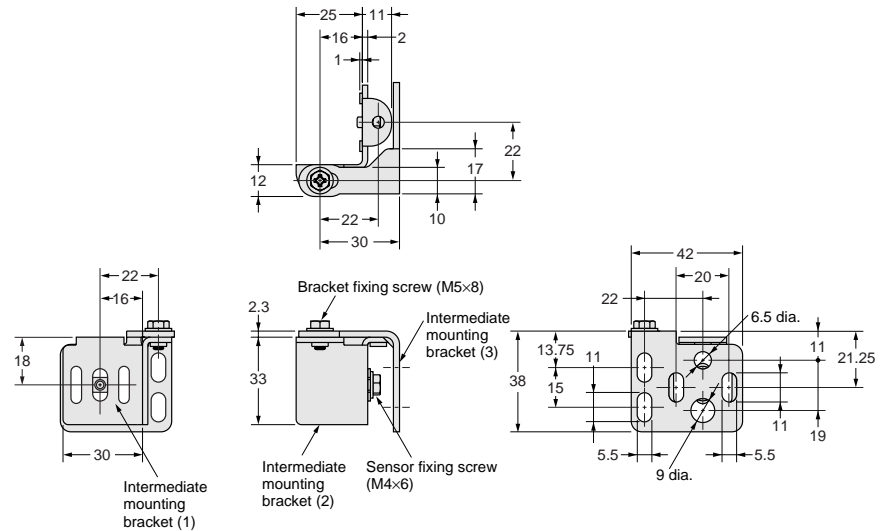

Accessories (Sold Separately)

Double-ended Connector Cable

- F39-JCR2 (L = 0.2 m)
- F39-JC3 (L = 3 m)
- F39-JC7 (L = 7 m)
- F39-JC10B (L = 10 m)
- F39-JC15 (L = 15 m)

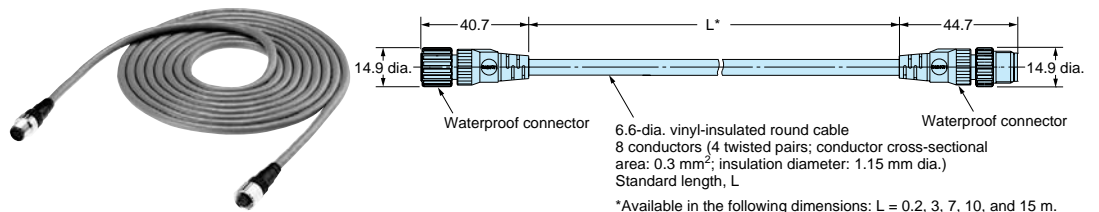

Color:
 Emitter: Gray
 Receiver: Black

*Available in the following dimensions: L = 0.2, 3, 7, 10, and 15 m.

Read and Understand This Catalog

Please read and understand this catalog before purchasing the products. Please consult your OMRON representative if you have any questions or comments.

Warranty and Limitations of Liability

WARRANTY

OMRON's exclusive warranty is that the products are free from defects in materials and workmanship for a period of one year (or other period if specified) from date of sale by OMRON.

OMRON MAKES NO WARRANTY OR REPRESENTATION, EXPRESS OR IMPLIED, REGARDING NON-INFRINGEMENT, MERCHANTABILITY, OR FITNESS FOR PARTICULAR PURPOSE OF THE PRODUCTS. ANY BUYER OR USER ACKNOWLEDGES THAT THE BUYER OR USER ALONE HAS DETERMINED THAT THE PRODUCTS WILL SUITABLY MEET THE REQUIREMENTS OF THEIR INTENDED USE. OMRON DISCLAIMS ALL OTHER WARRANTIES, EXPRESS OR IMPLIED.

LIMITATIONS OF LIABILITY

OMRON SHALL NOT BE RESPONSIBLE FOR SPECIAL, INDIRECT, OR CONSEQUENTIAL DAMAGES, LOSS OF PROFITS, OR COMMERCIAL LOSS IN ANY WAY CONNECTED WITH THE PRODUCTS, WHETHER SUCH CLAIM IS BASED ON CONTRACT, WARRANTY, NEGLIGENCE, OR STRICT LIABILITY.

In no event shall responsibility of OMRON for any act exceed the individual price of the product on which liability is asserted.

IN NO EVENT SHALL OMRON BE RESPONSIBLE FOR WARRANTY, REPAIR, OR OTHER CLAIMS REGARDING THE PRODUCTS UNLESS OMRON'S ANALYSIS CONFIRMS THAT THE PRODUCTS WERE PROPERLY HANDLED, STORED, INSTALLED, AND MAINTAINED AND NOT SUBJECT TO CONTAMINATION, ABUSE, MISUSE, OR INAPPROPRIATE MODIFICATION OR REPAIR.

Application Considerations

SUITABILITY FOR USE

OMRON shall not be responsible for conformity with any standards, codes, or regulations that apply to the combination of products in the customer's application or use of the product.

At the customer's request, OMRON will provide applicable third party certification documents identifying ratings and limitations of use that apply to the products. This information by itself is not sufficient for a complete determination of the suitability of the products in combination with the end product, machine, system, or other application or use.

The following are some examples of applications for which particular attention must be given. This is not intended to be an exhaustive list of all possible uses of the products, nor is it intended to imply that the uses listed may be suitable for the products:

- Outdoor use, uses involving potential chemical contamination or electrical interference, or conditions or uses not described in this catalog.
- Nuclear energy control systems, combustion systems, railroad systems, aviation systems, medical equipment, amusement machines, vehicles, safety equipment, and installations subject to separate industry or government regulations.
- Systems, machines, and equipment that could present a risk to life or property.

Please know and observe all prohibitions of use applicable to the products.

NEVER USE THE PRODUCTS FOR AN APPLICATION INVOLVING SERIOUS RISK TO LIFE OR PROPERTY WITHOUT ENSURING THAT THE SYSTEM AS A WHOLE HAS BEEN DESIGNED TO ADDRESS THE RISKS, AND THAT THE OMRON PRODUCT IS PROPERLY RATED AND INSTALLED FOR THE INTENDED USE WITHIN THE OVERALL EQUIPMENT OR SYSTEM.

Disclaimers

CHANGE IN SPECIFICATIONS

Product specifications and accessories may be changed at any time based on improvements and other reasons.

It is our practice to change model numbers when published ratings or features are changed, or when significant construction changes are made. However, some specifications of the product may be changed without any notice. When in doubt, special model numbers may be assigned to fix or establish key specifications for your application on your request. Please consult with your OMRON representative at any time to confirm actual specifications of purchased product.

DIMENSIONS AND WEIGHTS

Dimensions and weights are nominal and are not to be used for manufacturing purposes, even when tolerances are shown.

ERRORS AND OMISSIONS

The information in this catalog has been carefully checked and is believed to be accurate; however, no responsibility is assumed for clerical, typographical, or proofreading errors, or omissions.

PERFORMANCE DATA

Performance data given in this catalog is provided as a guide for the user in determining suitability and does not constitute a warranty. It may represent the result of OMRON's test conditions, and the users must correlate it to actual application requirements. Actual performance is subject to the OMRON Warranty and Limitations of Liability.

PROGRAMMABLE PRODUCTS

OMRON shall not be responsible for the user's programming of a programmable product, or any consequence thereof.

COPYRIGHT AND COPY PERMISSION

This catalog shall not be copied for sales or promotions without permission.

This catalog is protected by copyright and is intended solely for use in conjunction with the product. Please notify us before copying or reproducing this catalog in any manner, for any other purpose. If copying or transmitting this catalog to another, please copy or transmit it in its entirety.