

項目		規格・性能	
定格電源電圧		DC24V ±10% リップル(p-p)10%以下	
電源投入後立ち上がり時間		5秒以下	
制御回路の保護		出力負荷短絡保護、電源逆接続保護(注1)	
過電圧カテゴリ (IEC60664-1)		出力負荷短絡保護、電源逆接続保護(注1)	
絶縁抵抗		リード線一括 - ケース外部間 100M 以上 (DC500V メガにて)	
耐電圧		リード線一括 - ケース外部間 AC2200V 50/60Hz 1min.	
周囲温度		動作時: -10 ~ +50 (ただし、氷結、結露なきこと、) 保存時: -30 ~ +70 (ただし、氷結、結露なきこと、)	
周囲湿度		動作時: 保存時: 各 35 ~ 85%RH (ただし、氷結、結露なきこと、)	
耐振動		10 ~ 55Hz 振幅 0.7mm X,Y,Z 各方向 20 掃引 (通電)	
耐衝撃		100m/s ² X,Y,Z 各方向 1,000 回 (通電)	
ケース材質		ガラス繊維強化ポリアミド 66(PA-66-FR)	
保護構造		端子台: IP20、本体: IP40(IEC60529)	
入力	非常停止入力	ON : DC15 ~ 24V ±10% OFF: オープンあるいは、0 ~ DC5V 以下	
	リセット入力	内部インピーダンス: 約 5k	
	フィードバック入力		
	補助入力		
DC 半導体出力	外部表示灯出力(注2)	接続可能な表示灯 フィラメントタイプ(白熱ランプ) DC24V、3 ~ 7W	
	補助出力	PNP トランジスタ出力 負荷電流: 25mA 以下、残留電圧: 2V 以下(注3)	
リレー接点出力	主接点(安全出力)数	2a	
	補助接点(補助出力)数	1b	
	定格負荷	抵抗負荷 11/12 端子 (補助接点: 補助出力)	AC250V 50/60Hz DC30V 5A
		23/24 端子 33/34 端子 (主接点: 安全出力)	AC250V 50/60Hz DC30V 3.15A(5A) (注4)
	誘導負荷	AC15: AC240V / 2A cos φ=0.3	
		DC13: DC24V / 1A L/R=48ms	
		最小適用負荷(注5)	DC24V / 5mA(参考値)(注6)
電気的耐久性(注5)		10 万回以上(開閉頻度 1800 回/h)	
機械的耐久性(注5)	1000 万回以上(開閉頻度 36000 回/h)		
安全カテゴリ、パフォーマンスレベル(PL) (EN ISO13849-1)	カテゴリ 4, PL e		
安全度水準 (IEC61508)	SIL3		
定格電流	650mA以下(入出力などの接続機器消費電流を除く)		
応答時間	即断補助出力(AS1 端子)	ON OFF: 35ms 以下 OFF ON: 147ms 以下	
	安全リレー - 出力(23/24 端子/33/34 端子) 補助リレー - 出力(11/12 端子)	応答時間: 45ms 以下 動作時間: 177ms 以下	
オフデレール時間 (R2 モジュール) (23/24 端子/33/34 端子)	0.5 秒 ~ 600 秒 (注7)		
質量	約 0.7kg(本体のみ)		
外形	7 スロット: 157.5(W) × 111(H) × 113(D)		
接続可能な入力機器	非常停止スイッチ(1ch, 2ch 共用) セーフティライカ・テン 2 セット セーフティアスイッチ(1ch, 2ch 共用) 2 セット		

- (注1) 本保護機能が作動した場合は、電源再投入にて復帰してください。
(注2) 外部表示灯を接続しない場合は、EL1 端子 - EL2 端子間に抵抗(1/4W, 4.7k) を接続してください。
右図に示す形状のリード線付抵抗(極性はありせん)を本製品に付属してあります。
(注3) コード延長による電圧降下を除く。
(注4) 安全リレー出力に外部ヒューズを設ける必要があります。安全カテゴリによりヒューズ定格が異なります。
カテゴリ 4, PL e(EN ISO13849-1)で使用する場合
安全リレー出力を接点溶着から保護するために外部にヒューズを設ける必要があります。ヒューズ定格は3.15A以下です。リレー接点に印加できる電流は、ヒューズ定格により制限されて3.15A以下(抵抗負荷)となります。
カテゴリ 3, PL d(EN ISO13849-1)以下で使用する場合
外部に設けるヒューズ定格は5A以下です。リレー接点に印加できる電流は、ヒューズ定格により制限されて5A以下(抵抗負荷)となります。
詳しくは、prEN50156-1 の 10.4.3.4 章を参照してください。
(注5) 内蔵しているリレー単体の性能。耐久性の条件は、周囲温度 +15 ~ +35、周囲湿度 25 ~ 75%RH です。
(注6) 参考値です。これ以下での使用には適しません。一度でも大きい負荷をかけますと微小負荷の開閉ができなくなる可能性があります。
(注7) 出荷時のオフデレール時間は、“0 秒”(即断)に設定されています。(F3SX 用機能設定支援ソフト(形 F3SX-CD、別売)にて設定可能です。)

メインモジュール

表示	色	名称	機能
PW	緑	電源表示灯	通電しているときに点灯します。
ER	赤	エラー表示灯	エラーが発生したときに、点灯または点滅します。 点灯: 非常停止入力間で同期がとれていない 1 回点滅: 非常停止入力間が短絡・配線ミス 2 回点滅: 非常停止入力回路が故障・配線ミス 3 回点滅: Y1, Y2, Y3 端子の配線ミス・断線 4 回点滅: 外部表示灯の故障、表示出力回路の故障 5 回点滅: 安全リレー出力回路の故障、溶着 6 回点滅: 外部機器からのフィードバック信号の異常 常時点滅: ノイズの影響、F3SX 内部回路の故障
RS	緑	リセット入力表示灯	次の場合に点灯します。 ・オートリセット時: Y3 端子が入力 ON のとき ・マニュアルリセット時: Y2 端子が入力 ON のとき
LK	黄	インターロック表示灯	インターロック状態のときに点灯します。
T1	緑	T12 入力表示灯	T12 端子が入力 ON のときに点灯します。
T2	緑	T22 入力表示灯	T22 端子が入力 ON のときに点灯します。
EL	緑	表示灯出力 ON 表示灯	表示灯出力が ON のときに点灯します。
FB	緑	フィードバック入力表示灯	フィードバック入力端子が ON のときに点灯します。

L2 モジュール

表示	色	名称	機能
ER1	赤	エラー表示灯	端子 5 または端子 7 入力異常時に、点灯または点滅します。 点灯: 入力間で同期がとれていない 1 回点滅: 入力間が短絡・配線ミス 2 回点滅: 入力回路が故障・配線ミス
ER2	赤	エラー表示灯	端子 12 または端子 10 入力異常時に、点灯または点滅します。 点灯: 入力間で同期がとれていない 1 回点滅: 入力間が短絡・配線ミス 2 回点滅: 入力回路が故障・配線ミス
D1	緑	端子 5 入力表示灯	端子 5 入力時に点灯します。
D2	緑	端子 7 入力表示灯	端子 7 入力時に点灯します。
D3	緑	端子 12 入力表示灯	端子 12 入力時に点灯します。
D4	緑	端子 10 入力表示灯	端子 10 入力時に点灯します。

D1 モジュール

表示	色	名称	機能
ER1	赤	エラー表示灯	端子 5 または端子 7 入力異常時に、点灯または点滅します。 点灯: 入力間で同期がとれていない 1 回点滅: 入力間が短絡・配線ミス 2 回点滅: 入力回路が故障・配線ミス
ER2	赤	エラー表示灯	端子 12 または端子 10 入力異常時に、点灯または点滅します。 点灯: 入力間で同期がとれていない 1 回点滅: 入力間が短絡・配線ミス 2 回点滅: 入力回路が故障・配線ミス
D1	緑	端子 5 入力表示灯	端子 5 入力時に点灯します。
D2	緑	端子 7 入力表示灯	端子 7 入力時に点灯します。
D3	緑	端子 12 入力表示灯	端子 12 入力時に点灯します。
D4	緑	端子 10 入力表示灯	端子 10 入力時に点灯します。

リレー出力モジュール (R モジュール)

表示	色	名称	機能
EN1	緑	安全リレー出力 ON 表示灯	安全リレー出力 ON のときに点灯します。
EN1	赤	安全リレー出力 OFF 表示灯	安全リレー出力 OFF のときに点灯します。

リレー出力モジュール (R2 モジュール)

表示	色	名称	機能
EN3	緑	安全リレー出力 ON 表示灯	安全リレー出力 ON のときに点灯します。 オフデレール動作中は、下記に示す周期で点滅します。 オフデレール残り時間が 20 秒以上 : 1Hz 周期 オフデレール残り時間が 10 秒以上 : 2Hz 周期 オフデレール残り時間が 5 秒以上 : 3Hz 周期 オフデレール残り時間が 5 秒未満 : 4Hz 周期
EN3	赤	安全リレー出力 OFF 表示灯	安全リレー出力 OFF のときに点灯します。

付属品
抵抗器 (1/4W, 4.7k) …… 1 個
(外部表示灯を接続しない場合は、本付属品を EL1 端子 - EL2 端子間に接続してください)

配線例

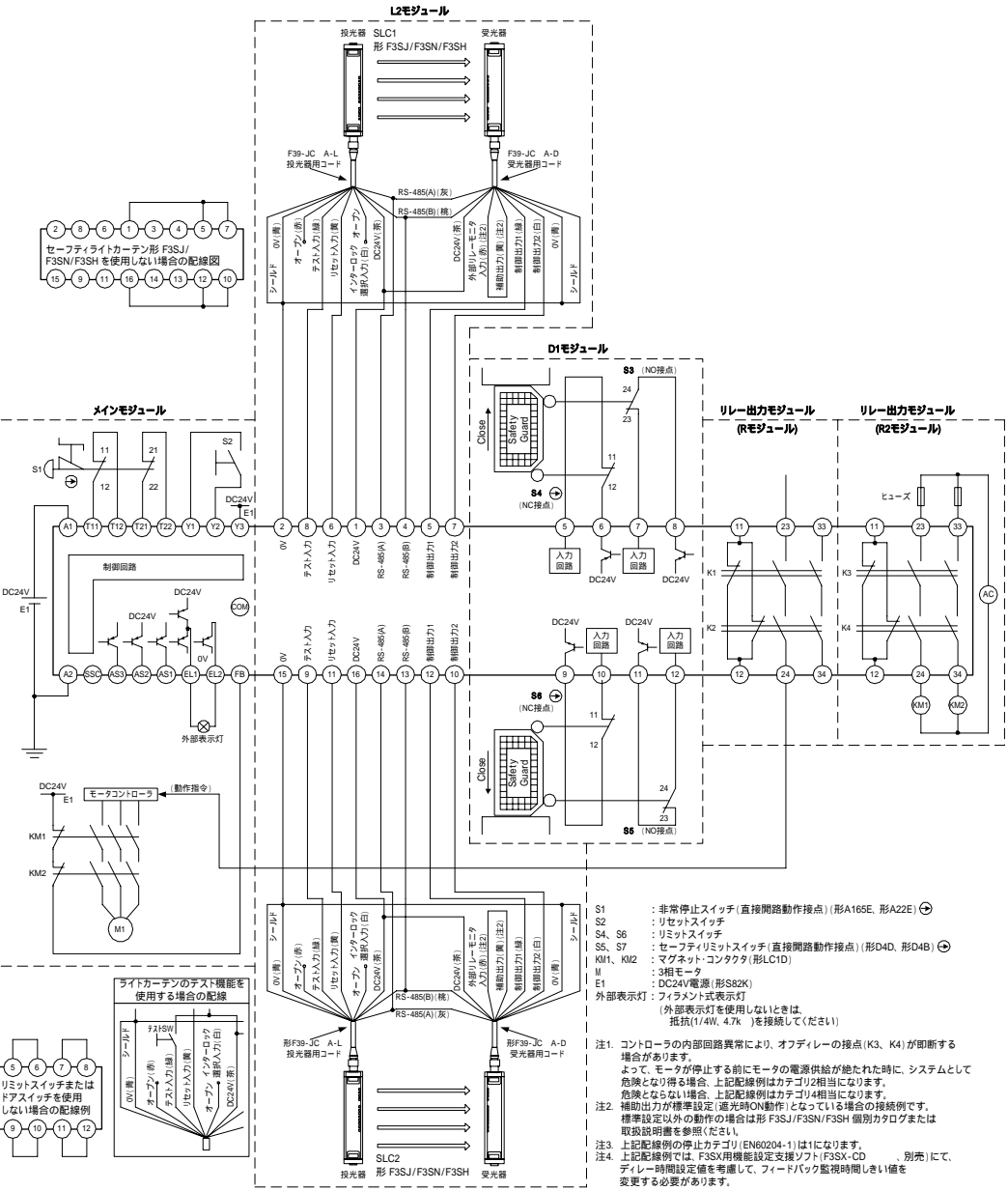

信号名	端子名	動作概要	不使用時の配線
補助出力	AS1	安全状態が否かを出力します。	オープン
	AS2	エラー情報、出力切替回数超過情報、および通電時間超過情報がある場合、出力 ON します。これらの情報が無い場合は出力 OFF です。上位側へのコマンド要求として使用することができます。	オープン
	AS3	電源投入後、F3SX の CPU が初期化され、入出力が正常に制御可能な状態になったときに出力 ON します。ロックアウト時、またはメインモジュールに接続した非常停止スイッチの押し下げ時に、出力 OFF します。	オープン
フィードバック入力	FB	外部装置の状態を監視するため、外部コンタクトの接続など、安全出力と論理が反転した信号を入力します。フィードバック入力信号と、安全出力が同期しているかを監視しており、同期していない場合、または監視期間内にフィードバック信号が入力されない場合にロックアウト状態となります。	使用しない場合は、下図のように配線してください。
始動命令入力	SSC	上位側からの始動命令を入力します。始動命令入力および接続された入力機器の両信号が ON の時に安全出力を ON します。	A1 端子と直接接続してください

(注1) R1/R2 モジュールの場合は、F3SX 用機能設定支援ソフト(形 F3SX-CD、別売)にて、デレール時間設定値を考慮して、フィードバック監視時間しきい値を変更する必要があります。

リセット入力の配線

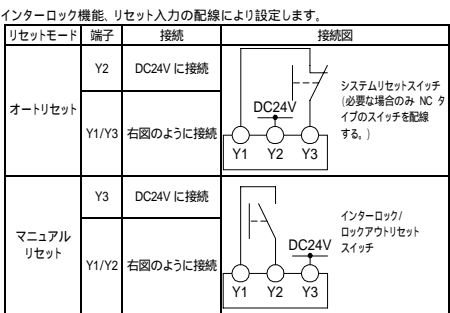

リセット
・Y1 - Y3 間(オートリセット時)、または Y1 - Y2 間(マニュアルリセット時)に接続されたリセットスイッチを押すことで、F3SX のリセットをかけることができます。
・マニュアルリセットがオートリセットかにより、リセット内容および条件が異なります。(次表参照)
・リセットスイッチを 3 秒以上押下げることで、システムリセットがかかります。システムリセットにより、電源を再投入した状態となります。
・システムリセット入力を受付けるのは、安全出力が OFF している場合です。
・システムリセットは、ロックアウトを解除するために使用します。

リセットモード	F3SX の状態	リセット入力時間(リセット押下時間)	
		50ms 入力時間 < 3s	3s 入力時間
オートリセット時	安全出力 ON 状態	-	-
	ロックアウト時	-	システムリセット
マニュアルリセット時	安全出力 OFF 状態	インタ・ロックのリセット	システムリセット
	安全出力 ON 状態	-	-
ロックアウト時	安全出力 ON 状態	-	-
	安全出力 OFF 状態	-	システムリセット

エラー表示と対策

F3SX がエラーを検知した場合、ER の表示灯が点灯、または点滅しエラー内容を知らせます。下表に従って対策を実施してください。

ER 表示灯の動作	内容	原因	対策
点灯	非常停止スイッチの入力同期エラー	非常停止スイッチの接続不良、非常停止スイッチとの配線が正しくない	非常停止スイッチとの配線が正しいか確認する。
1 回点滅	非常停止スイッチ入力間の短絡・配線異常	非常停止スイッチの配線がショートした。	非常停止スイッチ、または配線が正しいか確認する。
2 回点滅	非常停止スイッチ入力端子回路の異常	非常停止スイッチ入力回路の故障、過大なノイズの影響を受けている。	F3SX を交換する。 F3SX 周辺のノイズ環境を確認する。
3 回点滅	リセット入力端子の異常	リセット入力端子の配線が正しくない、リセット入力端子の配線が断線・ショートした。	リセット入力端子の配線が正しいか確認する。 リセット入力端子の配線が正しいか確認する。
4 回点滅	外部表示灯出力端子の異常	外部表示灯の故障、外部表示灯との配線が正しくない。	外部表示灯を交換する。 外部表示灯との配線が正しいか確認する。
5 回点滅	リレー出力端子の異常	リレー出力の故障、過大なノイズの影響を受けている。	F3SX を交換する。 F3SX 周辺のノイズ環境を確認する。
6 回点滅	フィードバック入力端子の異常	コンタクトなどの外部機器との配線が正しくない、コンタクトなどの外部機器の故障。	コンタクトなどの外部機器との配線が正しいか確認する。 コンタクトなどの外部機器を交換する。
常時点滅	ノイズ、または F3SX の故障	過大なノイズの影響を受けている、F3SX の内部回路が故障した。	F3SX 周辺のノイズ環境を確認する。 F3SX を交換する。

L2/D1 モジュール

ER1 表示灯は1系統側のエラー、ER2 表示灯は2系統側のエラーを表します。

ER1 / ER2 表示灯の動作	内容	原因	対策
点灯	入力機器の入力同期エラー	入力機器の接続不良、入力機器との配線が正しくない	入力機器、または配線が正しいか確認する。
1 回点滅	入力機器の入力間の短絡・配線異常	入力機器の配線がショートした。	入力機器との配線が正しいか確認する。
2 回点滅	入力機器の入力端子回路の異常	過大なノイズの影響を受けている、入力機器入力回路の故障。	F3SX 周辺のノイズ環境を確認する。 F3SX を交換する。

Original instructions



Model F3SX-N-L2D1RR2

Safety controller

INSTRUCTION SHEET

Please read and understand this instruction sheet before storing, installing, programming, operating, maintaining, or disposing of the products. Please consult your OMRON representative if you have any questions or comments.

Please refer to the F3SX User's Manual for detailed instructions on usage.

OMRON EUROPE B.V. (Representative in EU)
Wegalaan 67-69, 2132 JD Hoofddorp
The NETHERLANDS

©OMRON Corporation 2003 All Rights Reserved.
6997298-0C

Ratings and Specifications

For the ratings and specifications of Model F3SX Safety Controller, refer to the F3SX User's Manual in CD-ROM attached to the product. Please read the User's Manual and understand the ratings, features, installation procedure, wiring and connection method, etc., before using the F3SX.

Legislation and Standards

The F3SX alone cannot be applied to the "Type Test" pursuant to the Article 44 of the Industrial Safety and Health Law. It is necessary to apply by the entire system including the controller. Accordingly, in order to use F3SX in Japan as the "Safety device for press machine or shearing tool" pursuant to the Article 42 of the abovementioned law, it is necessary to apply for the test by the entire system.

F3SX is the product applicable to European Union (EU) Machinery Directive Annex IV, B, Safety Components, Item 1 and 2.

- 1) EC Declaration of Conformity
OMRON declares that F3SX is in conformity with the requirements of the following EC Directives:
-Machinery Directive 2006/42/EC
-Low Voltage Directive 2006/95/EC
-EMC Directive 2004/108/EC
2) European standards EN61508 (SIL1-3), EN ISO13849-1(Cat.4 PL e), EN61496-1 (Type4 ESPE), EN50178, EN55011, EN60204-1, EN61000-6-2, EN61000-6-4, EN1760, EN574 (Type IIC), EN1088
3) International standards IEC61508 (SIL1-3), IEC61496-1 (Type4 ESPE), IEC60204-1

We have obtained the following certificate of UL for F3SX.
-Listing certificate for the safety standards of USA and Canada.
UL508, UL1998, UL61496-1 (type4 ESPE), CSA C22.2 No.14, CSA C22.2 No.0.8

Suitability for Use

WARRANTY

OMRON's exclusive warranty is that the products are free from defects in materials and workmanship for a period of one year (or other period if specified) from date of sale by OMRON.

OMRON MAKES NO WARRANTY OR REPRESENTATION, EXPRESS OR IMPLIED, REGARDING NON-INFRINGEMENT, MERCHANTABILITY, OR FITNESS FOR PARTICULAR PURPOSE OF THE PRODUCTS. ANY BUYER OR USER ACKNOWLEDGES THAT THE BUYER OR USER ALONE HAS DETERMINED THAT THE PRODUCTS WILL SUITABLY MEET THE REQUIREMENTS OF THEIR INTENDED USE. OMRON DISCLAIMS ALL OTHER WARRANTIES, EXPRESS OR IMPLIED.

LIMITATIONS OF LIABILITY

OMRON SHALL NOT BE RESPONSIBLE FOR SPECIAL, INDIRECT, OR CONSEQUENTIAL DAMAGES, LOSS OF PROFITS OR COMMERCIAL LOSS IN ANY WAY CONNECTED WITH THE PRODUCTS, WHETHER SUCH CLAIM IS BASED ON CONTRACT, WARRANTY, NEGLIGENCE, OR STRICT LIABILITY.

In no event shall the responsibility of OMRON for any act exceed the individual price of the product on which liability is asserted.

IN NO EVENT SHALL OMRON BE RESPONSIBLE FOR WARRANTY, REPAIR, OR OTHER CLAIMS REGARDING THE PRODUCTS UNLESS OMRON'S ANALYSIS CONFIRMS THAT THE PRODUCTS WERE PROPERLY HANDLED, STORED, INSTALLED, AND MAINTAINED AND NOT SUBJECT TO CONTAMINATION, ABUSE, MISUSE, OR INAPPROPRIATE MODIFICATION OR REPAIR.

SUITABILITY FOR USE

OMRON shall not be responsible for conformity with any standards, codes, or regulations that apply to the combination of the product in the customer's application or use of the products.

At the customer's request, OMRON will provide applicable third party certification documents identifying ratings and limitations of use that apply to the products. This information by itself is not sufficient for a complete determination of the suitability of the products in combination with the end product, machine, system, or other application or use.

The following are some examples of applications for which particular attention must be given. This is not intended to be an exhaustive list of all possible uses of the products, nor is it intended to imply that the uses listed may be suitable for the products:

Outdoor use, uses involving potential chemical contamination or electrical interference, or conditions or uses not described in this instruction sheet.

Nuclear energy control systems, combustion systems, railroad systems, aviation systems, medical equipment, amusement machines, vehicles, safety equipment, and installations subject to separate industry or government regulations. Systems, machines, and equipment that could present a risk to life or property.

Please know and observe all prohibitions of use applicable to the products.

NEVER USE THE PRODUCT FOR AN APPLICATION INVOLVING SERIOUS RISK TO LIFE OR PROPERTY WITHOUT ENSURING THAT THE SYSTEM AS A WHOLE HAS BEEN DESIGNED TO ADDRESS THE RISKS, AND THAT THE OMRON PRODUCTS ARE PROPERLY RATED AND INSTALLED FOR THE INTENDED USE WITHIN THE OVERALL EQUIPMENT OR SYSTEM.

CHANGE IN SPECIFICATIONS

Product specifications and accessories may be changed at any time based on improvements and other reasons.

It is our practice to change model numbers when published ratings or features are changed, or when significant construction changes are made. However, some specifications of the products may be changed without any notice. When in doubt, special model numbers may be assigned to fix or establish key specifications for your application on your request. Please consult with your OMRON representative at any time to confirm actual specifications of purchased products.

DIMENSIONS AND WEIGHTS

Dimensions and weights are nominal and are not to be used for manufacturing purposes, even when tolerances are shown.

ERRORS AND OMISSIONS

The information in this document has been carefully checked and is believed to be accurate; however, no responsibility is assumed for clerical, typographical, or proofreading errors, or omissions.

COPYRIGHT AND COPY PERMISSION

This document shall not be copied for sales or promotions without permission.

This document is protected by copyright and is intended solely for use in conjunction with the product. Please notify us before copying or reproducing this document in any manner, for any other purpose. If copying or transmitting this document to another, please copy or transmit it in its entirety.

Precautions on Safety

Meanings of Signal Words



Indicates a potentially hazardous situation which, if not avoided, will result in minor or moderate injury, or may result in serious injury or death. Additionally there may be significant physical damage.



Indicates a potentially hazardous situation which, if not avoided, will occasionally result in minor or moderate injury, or result in physical damage to property.

Meanings of Alert Symbols



Indicates prohibited actions.



Indicates mandatory actions.

Alert Statements



DO NOT disassemble, modify, or attempt to repair the F3SX controller. Doing so may damage the original safety functions.

DO NOT operate the F3SX controller in a hazardous environment, such as an environment that contains flammable or explosive gas. Doing so may cause fire or explosion by electric arc generated in the internal relays or externally connected electromagnetic switches.

DO NOT connect the F3SX power input with a DC power supply or AC power supply exceeding the rated voltage. Also do not make reverse connection for the polarity of power supply. Doing either of these may cause breakdown of device and/or danger such as an electric shock.

DO NOT use the F3SX's communication functions for the purpose of configuring a safety system. Doing so may cause serious danger if any trouble occurs with the wiring or programming of the programmable controller.

DO NOT use the auxiliary input terminals (start command input) for connection with a safety input device for the purpose of configuring a safety system. Doing so may cause serious injury to humans when a trouble occurs with F3SX or the peripheral devices.

Apply neither of a voltage exceeding the rated nor an AC power supply across the auxiliary input terminals (start command input). Doing either of these may cause breakdown of device and/or danger such as an electric shock.

The auxiliary solid-state output (at the AS1, AS2 and AS3 terminals) is not a safety output. Do not use it for the purpose of configuring a safety system. Doing so may cause serious injury to humans when a trouble occurs with F3SX or the peripheral devices.

The external indicator output is not a safety output. Do not use it for the purpose other than indication. (N module built in types)

DC solid state safety output; Do not short-circuit the output lines to the 24V DC line. Doing so will make the output always ON and dangerous. Also, ground the 0V line of the power source so that the output does not become ON when the output line is grounded. (E module built in types)

The single-beam safety sensor input module (B1 module) of F3SX is for the exclusive use with the OMRON Model E3FS-10B4 (Type 2) and E3ZS-T81A(Type 2). Be sure to avoid connecting the module to the single-beam safety sensor other than the specified for the exclusive use. (B1 module built in types)

If the mode selection input line of the single-beam safety sensor receiver is connected to 0V, the output turns ON when light is interrupted (Dark ON), which no longer configures the safety system. Ensure connection of the mode selection input line to 24V DC to make the sensor output ON when light is incident (Light ON). (B1 module built in types)

Never use with a load in excess of the trip capacity (contact voltage, contact current). Doing so may damage the output circuit and cutoff may not be possible.

When transferring a F3SX product to another user, be sure to attach this User's Manual.

When this product is used in a safety system, a "Responsible Person" must strictly conform to the standards, legislations and regulations of the country and the local government under which the system is operated.

A "Responsible Person" who is well aware of and familiar with the machine must implement the installation of the F3SX and confirmation thereafter. And the users must have thorough understanding about the relevant installation requirements, safe distances, control devices and the functions before starting operation.

For the inspection and/or maintenance of the F3SX, a "Responsible Person" must confirm that the work has been properly performed.

In order to prevent hazardous situation, a "Responsible Person" must implement the inspections according to this User's Manual at least once for every six months. Failure to do so may lead to an accident including a serious injury to humans.

Whenever the F3SX does not operate properly, the user shall stop the machine immediately and report it to the "Responsible Person".

In order for F3SX to satisfy EN60204-1, IEC61496-1 and UL508, have the DC power unit comply with all of the following requirements.
• Voltage within the rated (24V DC ± 10%).
• Do not share the power source with other devices or machines. When the power source is shared by multiple devices, consider margins for the total rated current.
• Compliant with the EMC Directive, for Industrial environments.
• Double or reinforced insulation between the primary and secondary circuits.
• Automatic recovery of over-current protection characteristics (voltage drop).
• 20ms or over of the output hold time.
• Satisfies the output characteristics requirements of a class 2 circuit or equivalent limited energy circuit, as stipulated in UL508.
• Compliant with the laws and standards in relation to EMC and other electric device safety in the country or area where this unit is used. (Example: EMC Directive and Low Voltage Directive in EU.)

When using a commercialized switching regulator, be sure to ground FG (frame ground terminal). (If not grounded, it may cause erroneous operations due to the switching noises.)

Use appropriate control devices to materialize the safety functions. Failure to do so may cause deterioration in the safety performances.

Wiring must be done while the power is turned OFF either for F3SX or the devices connected with it. Doing it with the power ON may cause an electric shock. And external devices in connection with this product may behave in an unexpected way.

Ensure that the connections are made properly at the input and output terminals. Failure to ensure this may cause an electric shock or damage the safety functions.

Ensure that sufficient attention is given so that shared causes of faults do not cause the redundant safety circuit to become ineffective.

Set up a protective structure around the applicable machines so that nobody can reach the hazardous area of the machines without passing through the detection zone. If any works should be carried out in such hazardous area, set the sensors that always detect whole or a part of human bodies. Failure to do so causes the detection errors of human body and will lead to a serious injury.

Measure the maximum stop time with the actual machine configurations and periodically confirm that the stop time remains unchanged.

Never fail to secure the safety distances to the hazardous areas around the machine.

The reset switch must be installed in a place where the entire dangerous zone can be viewed, and in a way that the switch cannot be operated from the dangerous zone.

In order to maintain the safety functions, put the product in the state of output-OFF (the emergency-stop state) once every 24 hours.

Do not use F3SX for the machines that cannot be stopped immediately by the electric control at an emergency. Such machines cannot stop before the human body reaches the hazardous area and will cause a serious injury.

With regard to the relay output, install a fuse in serial with the output contacts. (Relay output module built in types)

Be sure to align the devices so as to prevent mutual interference when using multiple safety light curtains, multi-beam safety sensors or single-beam safety sensors. Failure to do so may cause non-detectable conditions and a serious injury to humans.

Regarding setting to F3SX by using the function set-up software for model F3SX (Model F3SXCD, sold separately), keep the set contents in the history. (Configurable types)

After changing any settings to F3SX by using the function set-up software for model F3SX (Model F3SXCD, sold separately), be sure to carry out the "Function test" and keep the test results in the history. (Configurable types)

DC solid-state safety output; Be sure to configure the safety system by using two channels. Only with one channel to be used, the safety functions of the system will be degraded. It may cause serious injury to humans when a trouble occurs. (E module built in types)

DC solid-state safety output; Connect a load across the output terminal and the 0V line (PNP output). If it is connected between the output terminal and the 24V DC line by mistake, the output may turn ON when an emergency-stop occurs and cause a dangerous situation. (E module built in types)

CAUTION

The safety category is determined by the entire safety control system. Design and use it in accordance with all the related standards. Consultation with an independent certification organization is recommended.

The life duration of the relays varies depending on the switching conditions or loads, etc. Use the relays within an appropriate switching times, after confirming the limit of switching times with the actual devices under the actual conditions.

If the DIN rail is too short for the width of F3SX, the product may drop out of the rail by vibration. Use end plate (Model PFP-M, sold separately), to fix F3SX on the DIN rail where necessary.

Use F3SX in an enclosure rated at least IP54 (IEC60529).

For ventilation, allow for 5mm or more on both sides of the F3SX and 50mm or more above and beneath.

Stranded wire should be processed with insulation-covered bar terminal (DIN46228-4 standard compatible type) at its ends before using for connection. Conforming wire (when using recommended bar terminals): 0.34 to 1.5mm² AWG22 to 16

Be careful not to catch a finger in the connector when installing it.

Connect firmly at the time of main body mounting and connect the cable connectors.

Allow some leeway for the wires and do not tighten the wires when wiring connection cables to F3SX, and confirm that any cable may not block the movements of workers or objects.

For the external indicator, use a filament-type lamp for the externally connected indicator. With an LED type indicator, the perfect detection of a trouble is not available. (N module built in types)

Precautions for Safe Use

Please observe the following precautions for safe use of the products.

- (1) Read this manual thoroughly to understand before using the product.
(2) Loads must satisfy all the conditions below:
Are not short-circuited.
Are not provided with the voltage higher than the rating.
Are not used with current higher than the rating.
(3) Provide the control circuit (24V DC circuit) of F3SX with double or reinforced insulation for protection from an electric shock.
(4) F3SX belongs to the over-voltage category II. Connect F3SX to the power distribution system of the over-voltage category II.
(5) Ground the minus terminal of 24V DC for the D-class earthing (through the earthing resistance of 100Ω max.).
(6) Put the product in the state of output-OFF (the emergency-stop state) once every 24 hours.
(7) Do not disassemble, repair or modify F3SX.
(8) Be sure to dispose of the F3SX as industrial waste.

Precautions for Correct Use

Please observe the following precautions to prevent operation failure, malfunctions, or undesirable effects on product performance.

- (1) Installation environment:
-Do not use F3SX at altitudes over 1,000 meters.
-Do not install the F3SX in the following environments:
•Areas with high-humidity where condensation is likely to occur;
•In the atmosphere with smoke or microparticles which may cause quality deterioration;
•In the atmosphere of corrosive, inflammable or explosive gases;
•Areas exposed to vibration or shock levels higher than specification provisions;
•Areas where the product may come in direct contact with water, oil, chemicals;
-Do not use radio equipment, such as cellular phones, walkie-talkies or transceivers which generate radio waves, near the F3SX.
-Protect the output circuit with a surge absorber when an inductive load is connected to the output.
-For ventilation and wiring, allow for 5mm on both sides of the F3SX, and 50mm or more above and beneath.
(2) Wiring and mounting
-Do not operate the control system until 5 seconds or more after turning ON the power of the F3SX.
-Do not have the input/output lines, such as that for sensor, share the same conduit with the high voltage or power electric lines.
-When replacing the metal connectors with other types such as resin connectors, use ones in the structure with the protection grade IP54 or higher.
-Wire correctly after confirming the signal names of all the terminals.
-Perform wiring between the input and output with a wiring length of 100m or less. When regulations specify that the wiring of a connected device must be 100m or less, perform wiring according to those regulations.
(3) Maintenance
-When cleaning, avoid using thinner, benzene or acetone.
(4) Standards
-The safety category is determined by the entire safety control system. Design and use it in accordance with all the related standards. Consultation with an independent certification organization is recommended.
-The customer is requested to make compliant with the applicable standards for the entire system.
(5) This is a class A product. In residential areas it may cause radio interference. In which case the Responsible Person may be required to take adequate measures to reduce interference.

Control Devices to Be Connected

The following signal words are used in this instruction sheet.

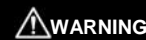

In order to maintain the total safety functions, use appropriate device for connection with the product. Failure to do so may cause degradation of the safety functions.

Table with 2 columns: Control device, Requirements. Lists various control devices like Emergency-stop switch, Door interlock switch, Two-hand control switch, Light curtain, Single-beam safety sensor, Relay, Electromagnetic breaker, and Other control devices with their specific requirements.



OMRON Corporation
Shiohji Horikawa, Shimogyo-ku, Kyoto, 600-8530 JAPAN
Tel: (81)75-344-7093 / Fax: (81)75-344-8197

OMRON EUROPE B.V
Wegalaan 67-69, NL-2132 JD Hoofddorp
THE NETHERLANDS
Tel: (31)-2356-81-300 / FAX: (31)-2356-81-388

Rating and Performance

Item		Rating and Performance		
Rated power voltage		DC24V ± 10% with ripple (p-p) of 10% or less		
Rise time at turning power on		5 seconds or less		
Protection for control circuit		Protection from short-circuiting of output load, and protection from reverse connection of power supply. (Note 1)		
Over-voltage category (IEC60664-1)		II		
Insulation resistance		Collective lead wire from all terminals - external enclosure: 100MΩ or more (by DC500V megger)		
Withstand voltage		Collective lead wire from all terminals - external enclosure: AC2200V, 50/60Hz for 1 min.		
Ambient temperature		Operating: -10 to +50 (not freezing or condensation) Storage: -30 to +70 (not freezing or condensation)		
Ambient humidity		Operating and storage: 35 to 85%RH each (not freezing or condensation)		
Vibration resistance		10 to 55Hz double amplitude of 0.7mm each in X, Y and Z direction, 20 sweeps (with power on)		
Shock resistance		100m/s ² each in X, Y and Z direction, 1,000 times (with power on)		
Enclosure materials		Glass fiber reinforced polyamide 66 (PA-66-FR)		
Protection structure		Terminal block: IP20, Main body: IP40 (IEC60529)		
Input	Emergency-stop input	ON : DC15 to 24V ± 10% OFF : Open or 0 to DC5V		
	Reset input	Internal impedance: Approximately 5kΩ		
	Feedback input			
	Auxiliary input			
DC solid-state output	External indicator output (Note 2)	External indicator which can be connected Filament type indicator DC24V, 3 to 7W		
	Auxiliary output	PNP transistor output Load current : 25mA max., Residual voltage : 2V max (Note 3)		
Relay contact output	Number of main contacts (safety outputs)		2 of NO	
	Number of auxiliary contacts (auxiliary outputs)		1 of NC	
	Rated load	Resistive load (Auxiliary contacts)	AC250V 50/60Hz DC30V 5A	
		Inductive load (Main contacts)	AC250V 50/60Hz DC30V 3.15A (5A) (Note 4)	
	Minimum applicable load (Note 5)		DC24V / 5mA (reference value) (Note 6)	
	Electrical endurance (Note 5)		100,000 times or more (open/close frequency of 1,800 times/h)	
	Mechanical endurance (Note 5)		10,000,000 times or more (open/close frequency of 36,000 times/h)	
Category, Performance level (PL) (EN ISO13849-1)		Cat.4, PL e		
Safety integrity level (IEC61508)		SIL3		
Rated current		650mA or less (except current consumption for the connected input/output devices)		
Response time	Instant breaking auxiliary output (AS1 terminal)	ON→OFF : 35ms or less OFF→ON : 147ms or less		
	Safety relay output (23/24 terminal, 33/34 terminal)	Response time : 45ms or less Operating time : 177ms or less		
	Auxiliary relay output (11/12 terminal)	Response time : 45ms or less Operating time : 177ms or less		
OFF-delay time (R2 Module) (23/24 terminal, 33/34 terminal)		0.5 to 600 seconds (Note 7)		
Weight		Approximately 0.7kg (main body only)		
External shape		7 slots : 157.5(W) x 111(H) x 113(D)		
Connectable input devices		Emergency-stop switch (common to Ch.1 and Ch.2) Safety light curtain 2 sets Safety door switch (common to Ch.1 and Ch.2) 2 sets		

- (Note 1) When this protection function operates, recover by turning the main power ON again.
- (Note 2) If no external indicator is connected, connect a resistor (4.7kΩ, 1/4W) between the EL1 and EL2 terminals. The resistor with lead wires (non-polar) shown in the right figure is attached to this product.
- (Note 3) Not including voltage drops in the extended wire.
- (Note 4) An external fuse must be inserted into the safety relay output. The fuse rating depends on the safety category.
- (1) For the use of the Category 4, PL e (EN ISO13849-1)
An external fuse must be inserted to protect the safety relay output contacts from welding. The fuse rating is 3.15A or less than 3.15A. The current that can be applied to the safety relay contacts is limited by the fuse rating and it is 3.15A or less than 3.15A (resistive load).
- (2) Use under the Category 3, PL d (EN ISO13849-1)
The external fuse rating is 5A or less than 5A. The current that can be applied to the safety relay contacts is limited by the fuse rating and it is 5A or less than 5A (resistive load). However, in this case, the safety relay output cannot be protected from welding.
- (Note 5) Performance of the built-in relay itself. * The values for endurance are those at ambient temperatures between +15 and +35°C and ambient humidities between 25 to 75%RH.
- (Note 6) Reference value. Use with less value is not appropriate. Note that, if loaded once with a higher value, the contacts may become unable to open/close for a small load.
- (Note 7) The OFF-delay time is set at 0 seconds (instant shut-off) at the delivery. (A setup with the function set-up software for model F3SX (Model F3SX-CD, sold separately) for F3SX is possible.)

Main Module

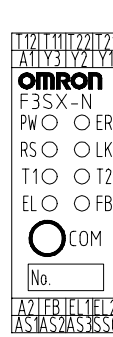

(LED Indicator)

Indication	Color	Name	Functions
PW	Green	Power indicator	Lights up while power is ON.
ER	Red	Error indicator	Lights up or flashes when an error occurs. Lighting up : No synchronization between emergency-stop inputs. 1-time flashing : Short-circuiting or mis-wiring between emergency-stop inputs. 2-time flashing : Trouble or mis-wiring around emergency-stop input circuit. 3-time flashing : Mis-wiring or break around Y1, Y2 or Y3 terminal. 4-time flashing : Trouble in external indicator or around the circuit for indicator output. 5-time flashing : Trouble or welding around safety relay output circuit. 6-time flashing : Error in feedback signals from an external devices. Continuously flashing : Affected by noises or trouble around the internal circuit of F3SX.
RS	Green	Reset input indicator	Lights up at the time of: • Auto resetting: Y3 terminal input is ON. • Manual resetting: Y2 terminal input is ON.
LK	Yellow	Interlock indicator	Lights up in interlock states.
T1	Green	T12 input indicator	Lights up when input is ON at T12 terminal.
T2	Green	T22 input indicator	Lights up when input is ON at T22 terminal.
EL	Green	Indicator output ON indicator	Lights up when indicator output is ON.
FB	Green	Feedback input indicator	Lights up when feedback input terminal is ON.

L2 Module

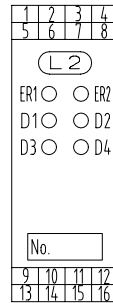

LED Indicator

Indication	Color	Name	Functions
ER1	Red	Error indicator	Lights up or flashes when Terminal 5 or Terminal 7 input error occurs. Light-up : Not synchronized between two terminal inputs 1 flash : Short circuit or wrong wiring between two terminal inputs 2 flashes : Failure or wrong wiring of input circuit
ER2	Red	Error indicator	Lights up or flashes when Terminal 12 or Terminal 10 input error occurs. Light-up : Not synchronized between two terminal inputs 1 flash : Short circuit or wrong wiring between two terminal inputs 2 flashes : Failure or wrong wiring of input circuit
D1	Green	Terminal 5 input indicator	Lights up for Terminal 5 input.
D2	Green	Terminal 7 input indicator	Lights up for Terminal 7 input.
D3	Green	Terminal 12 input indicator	Lights up for Terminal 12 input.
D4	Green	Terminal 10 input indicator	Lights up for Terminal 10 input.

D1 Module

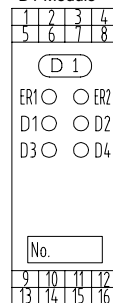

LED Indicator

Indication	Color	Name	Functions
ER1	Red	Error indicator	Lights up or flashes when Terminal 5 or Terminal 7 input error occurs. Light-up : Not synchronized between two terminal inputs 1 flash : Short circuit or wrong wiring between two terminal inputs 2 flashes : Failure or wrong wiring of input circuit
ER2	Red	Error indicator	Lights up or flashes when Terminal 12 or Terminal 10 input error occurs. Light-up : Not synchronized between two terminal inputs 1 flash : Short circuit or wrong wiring between two terminal inputs 2 flashes : Failure or wrong wiring of input circuit
D1	Green	Terminal 5 input indicator	Lights up for Terminal 5 input.
D2	Green	Terminal 7 input indicator	Lights up for Terminal 7 input.
D3	Green	Terminal 12 input indicator	Lights up for Terminal 12 input.
D4	Green	Terminal 10 input indicator	Lights up for Terminal 10 input.

Relay Output Module (R Module)

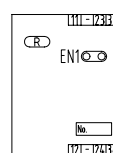

LED Indicator

Indication	Color	Name	Functions
EN1	Green	Safety relay output ON indicator	Lights up when safety relay output is ON.
EN1	Red	Safety relay output OFF indicator	Lights up when safety relay output is OFF.

Relay Output Module (R2 Module)

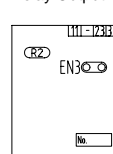

LED Indicator

Indication	Color	Name	Functions
EN3	Green	Safety relay output ON indicator	Lights up when safety relay output is ON. During the OFF-delay operation, it flashes in the cycles shown below. Residual OFF-delay time is 20 seconds or more: 1Hz cycle Residual OFF-delay time is 10 seconds or more: 2Hz cycle Residual OFF-delay time is 5 seconds or more: 3Hz cycle Residual OFF-delay time is less than 5 seconds: 4Hz cycle
EN3	Red	Safety relay output OFF indicator	Lights up when safety relay output is OFF.

Example of wiring

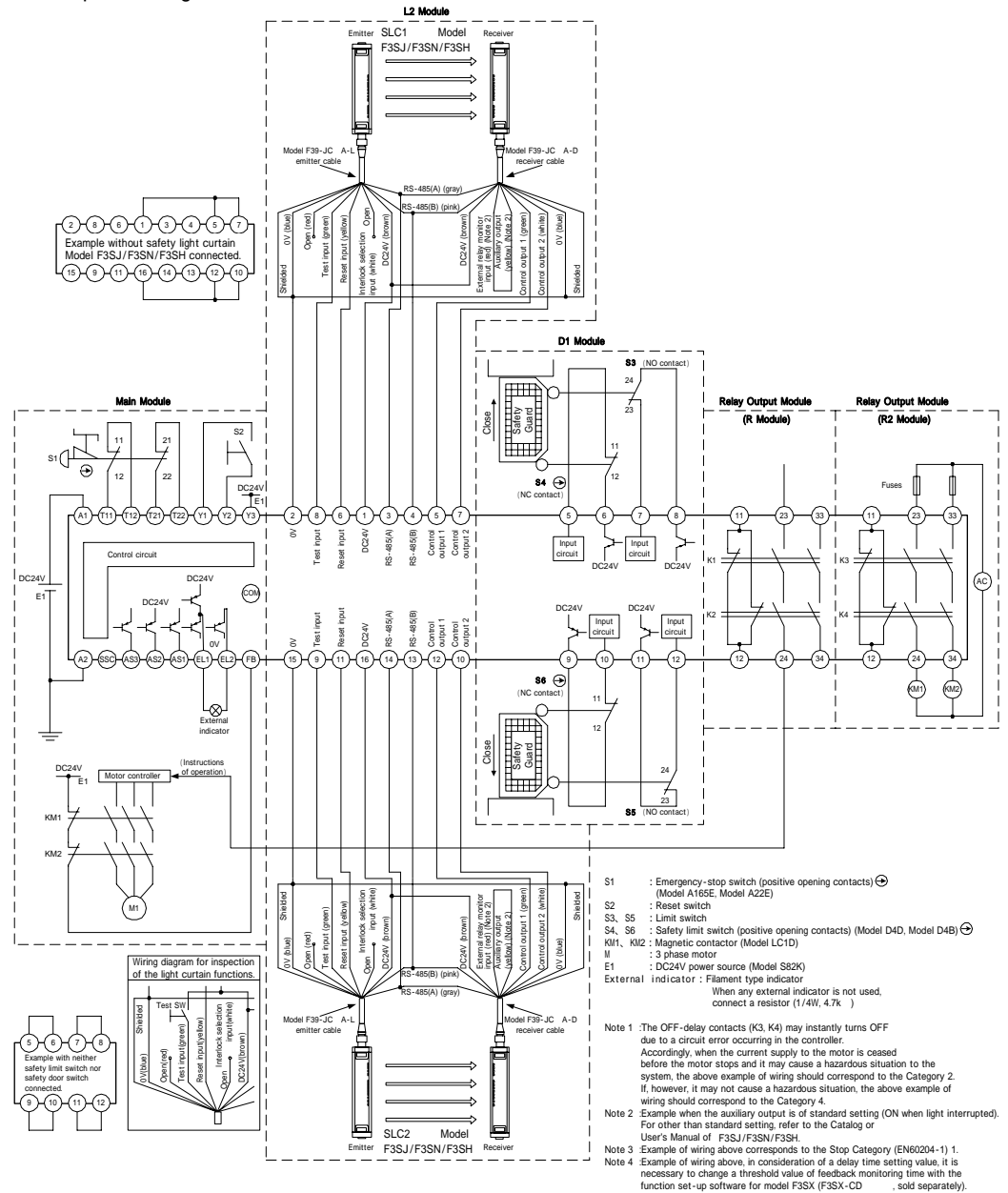

Signal name	Terminal name	Operations	Wiring when not used	
Auxiliary output	Instant breaking auxiliary output	AS1	Output the signals indicating whether the state is safe or not.	Open
	Information trigger	AS2	Turns output ON when error data, excessive frequency data of output switching and excessive power-ON time data are available. When these data does not exist, the output is turning OFF. Can be used as requests to the host side for a command.	Open
	Standby output	AS3	When F3SX CPU has been initialized and the input and output have turned into normally controllable state, the output is turning ON. The output is OFF when the emergency-stop switch, connected to the main module, is pressed or the F3SX is lock-out.	Open
Feedback input	FB	In order to monitor the status of external devices, feeds back the input signal that is logically reversal to the safety output, such as the NC contact of the external contactor. Meanwhile monitoring whether the feedback input signal and safety output are synchronous, the device is brought in the lock-out state when they do not synchronize or the feedback signal is not input during the monitoring time.	When not connected, wire as shown in the figure below.	
		Inputs the start command received from the host side. Turns the safety output ON when the start command input and input signal of the connected device are both ON.	Connect directly to the A1 terminal.	

(Note 1) When the R1/R2 module is used, in consideration of a delay time setting value, it is necessary to change a threshold value of feedback monitoring time with the function set-up software for model F3SX (F3SX-CD, sold separately).

Wiring for reset inputs

Interlock functions are set by the reset inputs wiring.

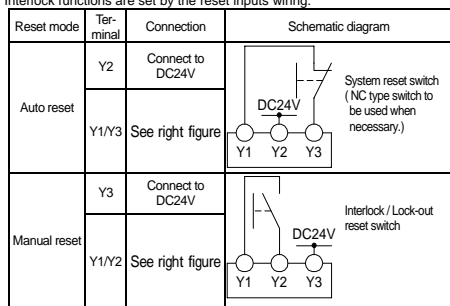

Reset

- F3SX can be reset by pressing the reset switch connected between Y1 and Y3 (for auto reset) or Y1 and Y2 (for manual reset).
- The details and conditions of reset vary depending on whether it is manual reset or auto reset.
- Pressing the reset switch for 3 seconds or longer enables the system reset. By system reset, it will be in the state where the power supply was re-switched on.
- The system-reset input can be accepted in which the safety output is OFF.
- System reset is used in order to cancel a lock-out.

Reset mode	State of F3SX	Time duration of reset input (while reset switch is pressed)	50ms ≤ input time < 3s	3s ≤ input time
Auto reset	Safety output ON state	-	-	-
	At lock-out	-	-	System-reset
Manual reset	Safety output OFF state	Reset of interlock	-	-
	Safety output ON state	-	-	System-reset
-	At lock-out	-	-	System-reset

Error indications and measures to be taken

When F3SX detects an error, indicator of ER lights up, or flashes to notify the error contents. Take appropriate measures according to the table below.

ER indication	Error	Assumed causes	Measures to be taken
Lighting up	Synchronization error of emergency-stop switch inputs.	Defects in emergency-stop switch contacts. Or improper wiring with emergency-stop switch.	Confirm emergency-stop switch or its wiring.
1-time flashing	Short-circuiting or wiring error among emergency-stop switch inputs.	Short-circuiting around emergency-stop switch wiring.	Confirm wiring with emergency-stop switch.
2-time flashing	Error around circuit of emergency-stop switch terminal.	Trouble with emergency-stop switch input circuit. Affected by noises of excess level.	Replace F3SX. Confirm noise environment surrounding F3SX.
3-time flashing	Error around reset input terminal.	Improper wiring with reset input terminal. Short-circuiting or wire break around reset input terminal.	Confirm wiring with reset input terminal. Replace F3SX.
4-time flashing	Error around external indicator output terminal.	Trouble with external indicator. Improper wiring with external indicator.	Replace external indicator. Confirm wiring with external indicator.
5-time flashing	Error around relay output terminal.	Trouble with relay output. Affected by noises of excess level.	Replace F3SX. Confirm noise environment surrounding F3SX.
6-time flashing	Error around feedback input terminal.	Improper wiring with external device such as contactor. Trouble with external device such as contactor.	Confirm wiring with external device such as contactor. Replace the external device such as contactor.
Continuously flashing	Disturbance by noises or trouble with F3SX.	Affected by noises of excess level. Trouble with F3SX internal circuit.	Confirm noise environment surrounding F3SX. Replace F3SX.

■ L2/D1 module
ER1 indication represents error occurring in the Ch.1, while ER2 indication represents error occurring in the Ch.2 side.

ER1/ER2 indication	Error	Assumed causes	Measures to be taken
Lighting up	Synchronization error around inputs of input device.	Defects in input device contacts. Or improper wiring with input device.	Confirm input device or its wiring.
1-time flashing	Short-circuiting or wiring error among input device.	Short-circuiting around input device.	Confirm wiring with input device.
2-time flashing	Error around input terminal circuit of input device.	Affected by noises of excess level. Trouble with input circuit of input device.	Confirm noise environment surrounding F3SX. Replace F3SX.

Attachment

Resistor (4.7kΩ, 1/4W) ---- 1 pc.
(Connect this attachment between the EL1 and EL2 terminals when connecting no external indicator.)

