

Vision Sensor FZ Series

FZ4-60_-10/FZ4-65_-10/FZ4-H60_-10/FZ4-H65_-10
 FZ4-70_-10/FZ4-75_-10/FZ4-H70_-10/FZ4-H75_-10
 FZ4-110_-10/FZ4-115_-10/FZ4-H110_-10/FZ4-H115_-10
 FZD-50_-10/FZD-55_-10

INSTRUCTION MANUAL (SETUP)

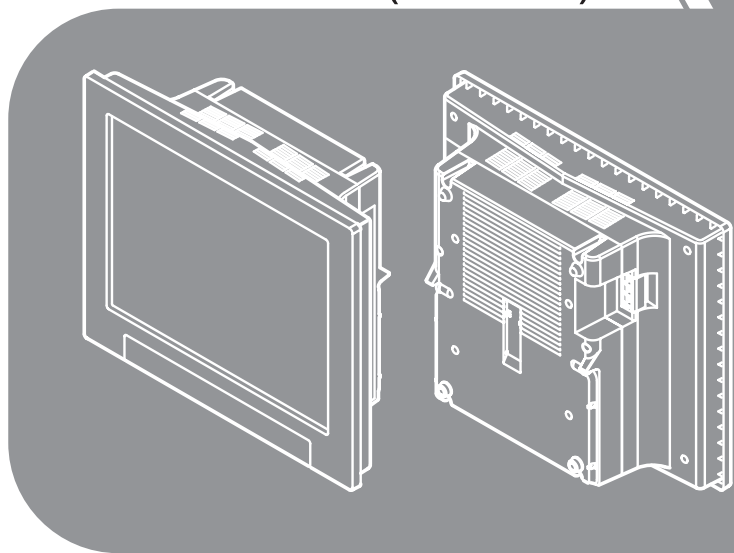

Thank you for selecting the FZ Series Vision Sensor.
 This manual explains how to use the FZ Series Vision Sensor.

When using the FZ Series Vision Sensor, make sure to observe the following:

- The FZ Series Vision Sensor must be operated by personnel knowledgeable in electrical engineering.
- To ensure correct use, please read this manual thoroughly to deepen your understanding of the product.
- Please keep this manual in a safe place so that it can be referred to whenever necessary.

* The meaning of “_” in model is described below.

0:NPN I/O type 5:PNP I/O type

TRACEABILITY INFORMATION:

Representative in EU:

Omron Europe B.V.

Wegalaan 67-69 2132 JD Hoofddorp, The Netherlands

Manufacturer:

Omron Corporation,

Shiokoji Horikawa, Shimogyo-ku, Kyoto 600-8530 JAPAN

Ayabe Factory

3-2 Narutani, Nakayama-cho, Ayabe-shi, Kyoto 623-0105 JAPAN

The following notice applies only to products that carry the CE mark:

Notice:

This is a class A product. In residential areas it may cause radio interference, in which case the user may be required to take adequate measures to reduce interference.



READ AND UNDERSTAND THIS DOCUMENT

Please read and understand this document before using the products. Please consult your OMRON representative if you have any questions or comments.

WARRANTY

OMRON's exclusive warranty is that the products are free from defects in materials and workmanship for a period of one year (or other period if specified) from date of sale by OMRON.

OMRON MAKES NO WARRANTY OR REPRESENTATION, EXPRESS OR IMPLIED, REGARDING NON-INFRINGEMENT, MERCHANTABILITY, OR FITNESS FOR PARTICULAR PURPOSE OF THE PRODUCTS. ANY BUYER OR USER ACKNOWLEDGES THAT THE BUYER OR USER ALONE HAS DETERMINED THAT THE PRODUCTS WILL SUITABLY MEET THE REQUIREMENTS OF THEIR INTENDED USE. OMRON DISCLAIMS ALL OTHER WARRANTIES, EXPRESS OR IMPLIED.

LIMITATIONS OF LIABILITY

OMRON SHALL NOT BE RESPONSIBLE FOR SPECIAL, INDIRECT, OR CONSEQUENTIAL DAMAGES, LOSS OF PROFITS OR COMMERCIAL LOSS IN ANY WAY CONNECTED WITH THE PRODUCTS, WHETHER SUCH CLAIM IS BASED ON CONTRACT, WARRANTY, NEGLIGENCE, OR STRICT LIABILITY.

In no event shall responsibility of OMRON for any act exceed the individual price of the product on which liability is asserted.

IN NO EVENT SHALL OMRON BE RESPONSIBLE FOR WARRANTY, REPAIR, OR OTHER CLAIMS REGARDING THE PRODUCTS UNLESS OMRON'S ANALYSIS CONFIRMS THAT THE PRODUCTS WERE PROPERLY HANDLED, STORED, INSTALLED, AND MAINTAINED AND NOT SUBJECT TO CONTAMINATION, ABUSE, MISUSE, OR INAPPROPRIATE MODIFICATION OR REPAIR.

SUITABILITY FOR USE

THE PRODUCTS CONTAINED IN THIS DOCUMENT ARE NOT SAFETY RATED. THEY ARE NOT DESIGNED OR RATED FOR ENSURING SAFETY OF PERSONS, AND SHOULD NOT BE RELIED UPON AS A SAFETY COMPONENT OR PROTECTIVE DEVICE FOR SUCH PURPOSES. Please refer to separate catalogs for OMRON's safety rated products.

OMRON shall not be responsible for conformity with any standards, codes, or regulations that apply to the combination of products in the customer's application or use of the product.

At the customer's request, OMRON will provide applicable third party certification documents identifying ratings and limitations of use that apply to the products. This information by itself is not sufficient for a complete determination of the suitability of the products in combination with the end product, machine, system, or other application or use.

The following are some examples of applications for which particular attention must be given. This is not intended to be an exhaustive list of all possible uses of the products, nor is it intended to imply that the uses listed may be suitable for the products:

- Outdoor use, uses involving potential chemical contamination or electrical interference, or conditions or uses not described in this document.
- Nuclear energy control systems, combustion systems, railroad systems, aviation systems, medical equipment, amusement machines, vehicles, safety equipment, and installations subject to separate industry or government regulations.
- Systems, machines, and equipment that could present a risk to life or property.

Please know and observe all prohibitions of use applicable to the products. NEVER USE THE PRODUCTS FOR AN APPLICATION INVOLVING SERIOUS RISK TO LIFE OR PROPERTY WITHOUT ENSURING THAT THE SYSTEM AS A WHOLE HAS BEEN DESIGNED TO ADDRESS THE RISKS, AND THAT THE OMRON PRODUCT IS PROPERLY RATED AND INSTALLED FOR THE INTENDED USE WITHIN THE OVERALL EQUIPMENT OR SYSTEM.

Meanings of Signal Words

The following signal words are used in this manual.



WARNING

Indicates a potentially hazardous situation which, if not avoided, will result in minor or moderate injury, or may result in serious injury or death. Additionally there may be significant property damage.



CAUTION

Indicates a potentially hazardous situation which, if not avoided, may result in minor or moderate injury or in property damage.

Meanings of Alert Symbols

The following alert symbols are used in this manual.



Indicates general prohibitions for which there is no specific symbol.



Indicates the possibility of electric shock under specific conditions.



Indicates the possibility of explosion under specific conditions.



Indicates the possibility of laser radiation.



Indicates the possibility of injury by high temperature under specific conditions.

Alert statements in this Manual

The following alert statements apply to the products in this manual. Each alert statement also appears at the locations needed in this manual to attract your attention.

⚠ WARNING

This product must be used according to the instruction manual. Failure to observe this may result in impairment of functions and performance of the product.

This product is not designed or rated for ensuring safety of persons. Do not use it for such purposes.

Do not open the cover. Doing so may result in electric shock from internally used high voltages.

A lithium battery is built into the Controller and may occasionally combust, explode, or burn if not treated properly. Dispose of the Controller as industrial waste, and never disassemble, apply pressure that would deform, heat to 100°C or higher, or incinerate the Controller.

Since this product emits a visible light that may have an adverse affect on the eyes, do not stare directly into the light emitted from the LED. If a specular object is used, take care not to allow reflected light enter your eyes.

⚠ CAUTION

Danger of burns

Do not touch the case while the LED is ON or just after power is turned OFF, since it remains extremely hot.

Precautions for Safe Use

● Installation Environment

- Do not use the product in areas where flammable or explosive gases are present.
- Install the product so that air can flow freely through its cooling vents.
- Do not install the product close to high-voltage devices and power devices in order to secure the safety of operation and maintenance.
- Make sure to tighten all installation screws securely.

● Power Supply and Wiring

- Make sure to use the product with the power supply voltage specified by this manual.
- Use a power supply cable and crimp terminals of the specified size. Do not simply connect the twisted ends of the wires directly to the terminal block.
 - Applicable wire size: 1.31 to 2.63 mm² - Crimp terminals 8.5 mm max.
 - Terminal screw: M4 8.5 mm max.
- Keep the power supply wires as short as possible (Max. 10 m).
- Use a DC power supply with safety measures against high-voltage spikes (safety extra low-voltage circuits on the secondary side).
- Ground the product's ground terminal to less than 100 Ω.
- Use a grounding point that is as close as possible and keep the ground wire as short as possible.
- Wire the Controller to the ground with a separate ground wire. To avoid grounding problems, do not share the ground wire with any other devices or wire the ground to the building's steel framing.
- Before turning on the power supply, confirm that the wiring is correct again.

● Other

- Use only the camera and cables designed specifically for the product. Failure to observe this may result in malfunction or damage of the product.
- Always turn OFF the Controller's power before connecting or disconnecting a camera or cable.
- Do not attempt to dismantle, repair, or modify the product.
- Should you notice any abnormalities, immediately stop use, turn OFF the power supply, and contact your OMRON representative.
- Do not touch fluorescent or halogen lights while the power is ON or immediately after the power is turned OFF.
- Dispose of this product as industrial waste

● Regulations and Standards

The Controller complies with the following standards.

EC Directive 2004/108/EC

EN standard EN61326-1

CSA Standard CSA C22.2 No.61010-1

● Regulation of KC marking

A 급 기기 (업무용 방송통신기자재)
이 기기는 업무용(A급) 전자파적합기기로서 판매자
또는 사용자는 이 점을 주의하시기 바라며, 가정외의
지역에서 사용하는 것을 목적으로 합니다.

● Ground

- The controller power circuit is not insulated from its internal circuit.
- When grounding the 24 V DC power supply's positive terminal, do not ground the controller's FG terminal or the PLC's FG terminal. 【①, ②】
Since the PC's shell and the SG (0V) are connected inside the PC, current would run through the route shown in the figure below and cause burnout.
- As in the case with a PC, you can safely ground the controller's FG terminal without a problem when there is no possibility that the SG (0V) and the FG will short-circuit. For information about the PLC wiring, check the specifications of your PLC before wiring.
- Be sure to use a pedestal when connecting a camera to the controller. 【③】
As the shell of the camera is the SG (0V), it can cause short-circuiting between the SG (0V) and the FG if a pedestal is not used.
- To avoid receiving an electric shock when grounding a positive terminal, do not touch the SG (0V) (camera, power supply terminal).
- When mounting a box-shaped controller (FZ4-65_-10/FZ4-H65_-10/FZ4-75_-10/FZ4-H75_-10/FZ4-115_-10/FZ4-H115_-10/FZD-55_-10) at its base, it will short-circuit to the FG of your device since the bottom surface is connected to the SG (0V). In order to avoid this, we provide insulating spacers. Please consult your OMRON representative for information.

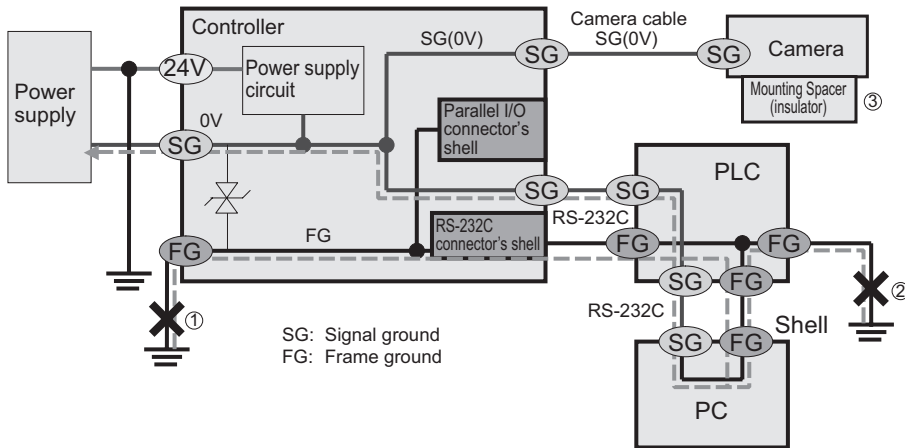

Precautions for Correct Use

● Installation and Storage Sites

Install and store the product in a location that meets the following conditions:

- Surrounding temperature of 0 to +50°C (-20 to +65°C in storage)
- No rapid changes in temperature (place where dew does not form)
- Relative humidity of between 35 to 85 %
- No presence of corrosive or flammable gases
- Place free of dust, salts and iron particles
- Place free of vibration and shock
- Place out of direct sunlight
- Place where it will not come into contact with water, oils or chemicals

● Orientation of Product

To improve heat dissipation, install the product in the following orientation only.

● Ambient Temperature

- Maintain a minimum clearance of 50 mm above and below the controller to improve air circulation. A minimum clearance of 10 mm between other devices must also be maintained on the right and left sides of the product. However, if the adjacent devices do not generate heat, provide at least 50 mm of clearance from the top of the Controller. For the clearance at the bottom and sides, follow the mounting method.
- Do not install the product immediately above significant heat sources, such as heaters, transformers, or large-capacity resistors.
- Do not let the ambient temperature exceed 50 °C (122 °F).
- Provide a forced-air fan cooling or air conditioning if the ambient temperature is near 50 °C (122 °F) so that the ambient temperature never exceeds 50 °C (122 °F).

● LCD integrated type

Do not install in this orientation.

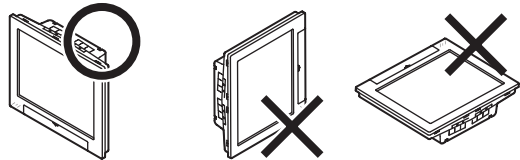

● Box type

To reserve ventilation path, the feet must be mounted to the side panel that is positioned at the base.

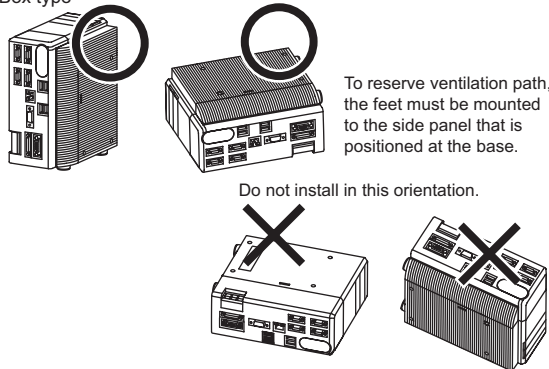

● **Noise Resistance**

- Do not install the product in a cabinet containing high-voltage equipment.
- Do not install the product within 200 mm of power cables.

● **Component Installation and Handling**

• **Touching Signal Lines**

To prevent damage from static electricity, use a wrist strap or another device for preventing electrostatic discharges when touching terminals or signal lines in connectors.

• **Handling a USB Memory**

To remove a USB memory, make sure that data is not being read or written to it.

The LED on the USB memory flashes while data is being read or written, so make sure that it is lit steadily before removing the memory.

• **Turning OFF the Power**

Do not turn OFF the power while a message is being displayed indicating that processing is being performed. Data in memory will be corrupted, and the product may not operate correctly the next time it is started.

• **Using the RESET Signal**

Do not use the RESET input immediately after power is turned ON. When using the RESET input to synchronize startup timing, wait at least 15 second after the Controller's power supply is turned ON before turning ON the RESET signal.

- The LCD panel used for the LCD-integrated type (FZ4-60_-10/FZ4-H60_-10/FZ4-70_-10/FZ4-H70_-10/FZ4-110_-10/FZ4-H110_-10/FZD-50_-10) has been made using precision technology, and sometimes a few pixels are missing in the panel. This is due to the structure of the LCD panel, and is not a malfunction.

● **Maintenance**

Turn OFF the power and take safety precautions before conducting inspections. Electrical shock can result from attempting safety inspections with the power turned ON.

- Clean the lens with a lens-cleaning cloth or air brush.
- Lightly wipe off dirt with a soft cloth.
- Dirt on the CCD must be removed using an air brush.
- Do not use thinners or benzene.

● **Communication with High-order Device**

After confirming that this product is started up, communicate with the high-order device.

When this product has started up, an indefinite signal may be output from the high-order interface.

To avoid this problem, clear the receiving buffer of your device at initial operations.

■ **Confirming Package Contents**

- Controller Qty.: 1
- Instruction Manual (this manual) Qty.: 1
- Mounting bracket (for panel) Qty.: 6 * Supplied with the LCD integrated type only.
- Touch pen Qty.: 1 * Supplied with the LCD integrated type only (provided inside the controller).

■ **U.S. California Notice:**

This product contains a lithium battery for which the following notice applies :Perchlorate Material - special handling may apply. See www.dtsc.ca.gov/hazardouswaste/perchlorate

■ **Mercury content**

LCD-integrated controllers (FZ4-60_-10/FZ4-H60_-10/FZ4-70_-10/FZ4-H70_-10/FZ4-110_-10/FZ4-H110_-10/FZD-50_-10) contain mercury in the fluorescent tube.

Observe local ordinances and regulations regarding disposal.

Basic Configuration Controller FZ4

* Items indicated with an asterisk are dedicated items, and cannot be substituted.

* **Controller**

Use the monitor to check images and display the condition-setting menus. The Controller performs the image processing specified by the user settings and outputs the measurement results.

LCD integrated type FZ4-600-10/FZ4-605-10
 FZ4-H600-10/FZ4-H605-10
 FZ4-700-10/FZ4-705-10
 FZ4-H700-10/FZ4-H705-10
 FZ4-1100-10/FZ4-1105-10
 FZ4-H1100-10/FZ4-H1105-10

Front view

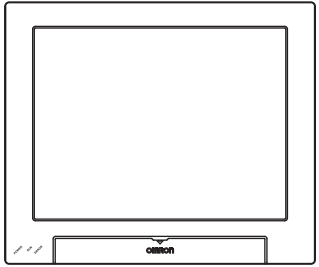

Right-side view

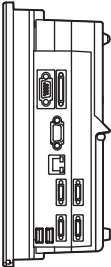

Touch pen (standard accessory)

* **Controller**

The Controller performs the image processing specified by the user settings and outputs the measurement results.

Box type FZ4-650-10/FZ4-655-10
 FZ4-H650-10/FZ4-H655-10
 FZ4-750-10/FZ4-755-10
 FZ4-H750-10/FZ4-H755-10
 FZ4-1150-10/FZ4-1155-10
 FZ4-H1150-10/FZ4-H1155-10

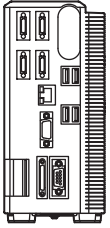

* **LCD monitor**

Use the monitor to check images and display the condition-setting menus.

FZ-M08 (8.4-inch)

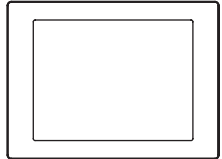

* **Monitor cable**

FZ-VM (2 m, 5 m)

* **Camera cable**

Camera cable
 FZ-VS (2 m, 5 m, 10 m)
 Bend resistant camera cable
 FZ-VSB (2 m, 5 m, 10 m)
 Right-angle camera cable
 FZ-VSL (2 m, 5 m, 10 m)
 Long-distance camera cable
 FZ-VS2 (15m)
 Long-distance Right-angle camera cable
 FZ-VSL2 (15m)

* **Camera**

Detects workpieces as images.

Intelligent camera
 FZ-SLC15/FZ-SLC100

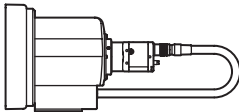

Automatic focus camera
 FZ-SZC15/FZ-SZC100

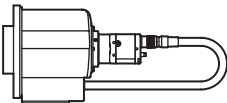

Standalone camera
 FZ-SC/FZ-S/FZ-SC2M
 FZ-S2M/FZ-SC5M/FZ-S5M
 FZ-SC5M2/FZ-S5M2/FZ-SFC
 FZ-SF/FZ-SPC/FZ-SP
 FZ-SHC/FZ-SH

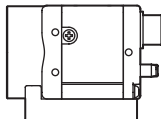

Intelligent compact camera
 FZ-SQ010F/FZ-SQ050F
 FZ-SQ100F/FZ-SQ100N

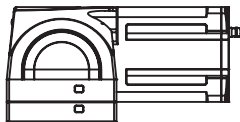

Power Supply

Recommended Model
 By OMRON Corporation
 S8VS-18024

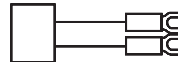

Peripheral Device

* USB memory
 FZ-MEM1G

Input Device

Mouse, track ball
 (Commercially available USB devices)

Basic Configuration Controller FZD

* Items indicated with an asterisk are dedicated items, and cannot be substituted.

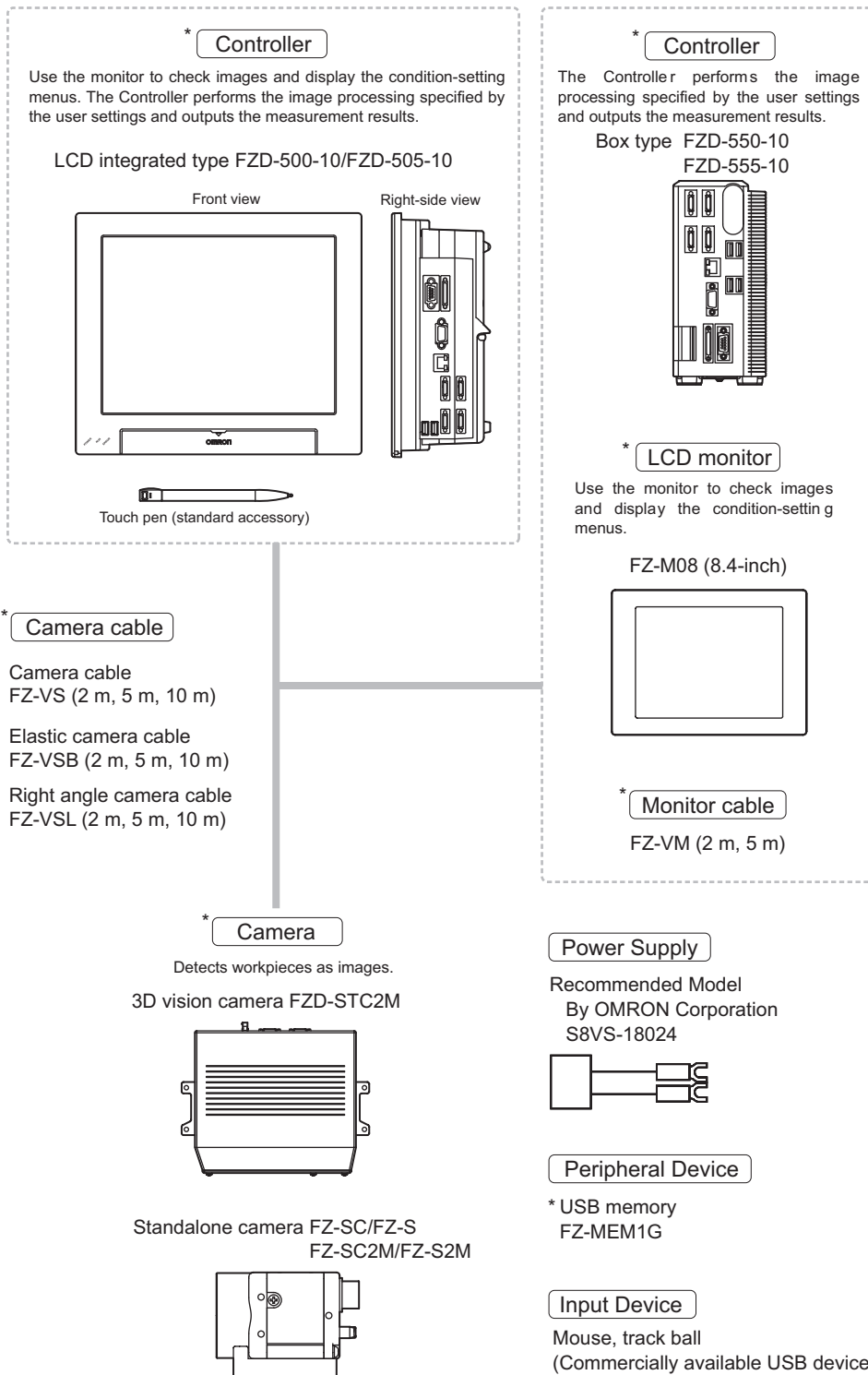

■ Component Names and Functions

- LCD integrated type FZ4-600-10/FZ4-605-10/FZ4-H600-10/FZ4-H605-10
FZ4-700-10/FZ4-705-10/FZ4-H700-10/FZ4-H705-10
FZ4-1100-10/FZ4-1105-10/FZ4-H1100-10/FZ4-H1105-10
FZD-500-10/FZD-505-10

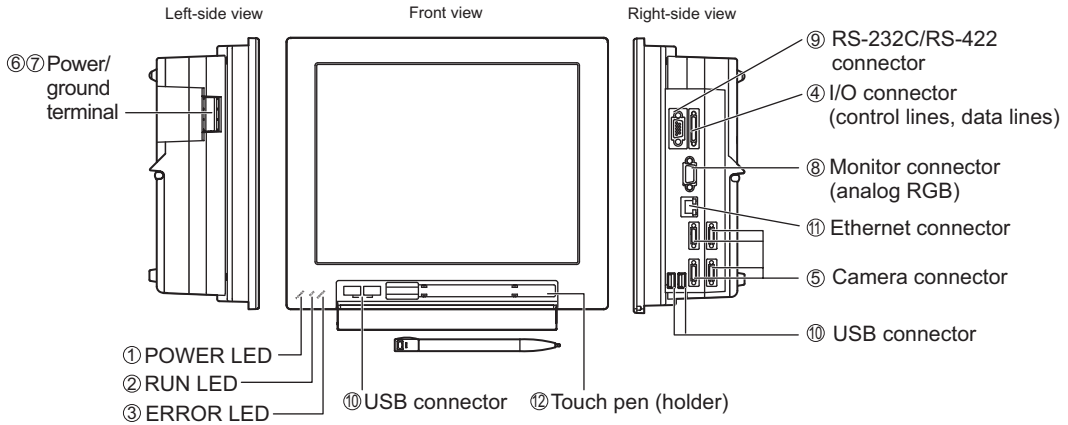

- Box type FZ4-650-10/FZ4-655-10/FZ4-H650-10/FZ4-H655-10
FZ4-750-10/FZ4-755-10/FZ4-H750-10/FZ4-H755-10
FZ4-1150-10/FZ4-1155-10/FZ4-H1150-10/FZ4-H1155-10
FZD-550-10/FZD-555-10

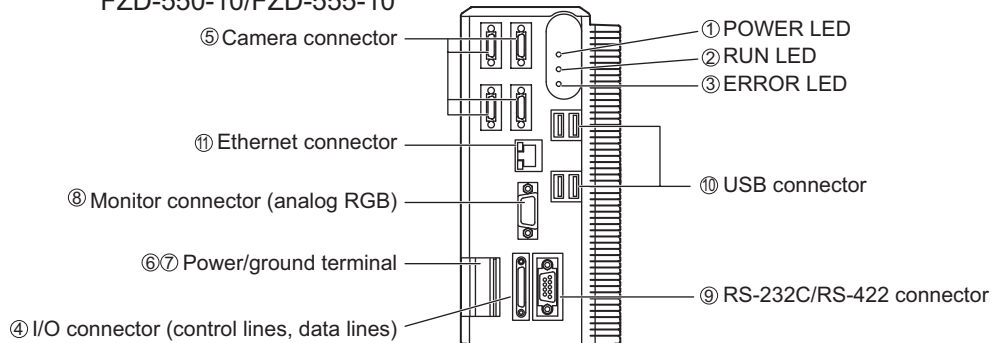

- ① Lit while power is ON.
- ② Lit while the controller is in Run Mode.
- ③ Lit when an error has occurred.
- ④ Connect the controller to external devices such as a sync sensor and PLC.
- ⑤ Connect cameras.
- ⑥ Connect a DC power supply. Wire the power supply unit independently of other devices. After wiring, replace the terminal cover.

Power Supply and Wiring p.3

- ⑦ Connect the ground wire. Make sure that the controller is grounded with a separate ground wire.
- ⑧ Connect a monitor.
- ⑨ Connect an external device such as a personal computer or PLC.
- ⑩ Connect a track ball, mouse and USB memory. A total of four USB ports are provided and any of them can be used. However, when connecting two or more USB memories, do not connect them to adjacent ports. Doing so may cause the USB memories to come into contact, resulting in malfunction or damage.

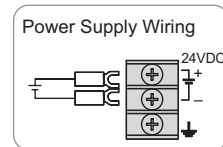

- The following items can be connected to USB ports. • Commercially available track ball and mouse • USB memory
- Never insert/remove USB devices during measurement. Doing so may affect measurement time.

- ⑪ Connect the controller to a personal computer.
- ⑫ A touch pen is stored. (Provided with the LCD integrated type only)



- The touch pen must be stored so that the pen tip faces to the right when viewed toward the controller.
- To remove the touch pen, push the left side (handle) of the pen to the rear. The pen's right side (pen tip) will pop out, so hold and remove the pen.

Parallel Interface

NPN I/O type FZ4-600-10/FZ4-650-10/FZ4-H600-10/FZ4-H650-10/FZ4-700-10/FZ4-750-10/FZ4-H700-10
FZ4-H750-10/FZ4-1100-10/FZ4-1150-10/FZ4-H1100-10/FZ4-H1150-10/FZD-500-10/FZD-550-10

Internal Specifications

[Input] signals: RESET, DI0 to DI7, DSA0, DSA1

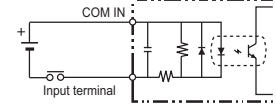
Input voltage	12 to 24 V DC ±10 %
ON current *1	5 mA min.
ON voltage *1	8.8 V min.
OFF current *2	0.5 mA max.
OFF voltage *2	1.1V max.
ON delay	5 ms max.
OFF delay	0.7 ms max.
Internal circuit	

*1 ON current/ON voltage

This refers to the current or voltage values needed to shift from the OFF → ON state. The ON voltage value is the potential difference between each of the input terminals and COM IN.

*2 OFF current/OFF voltage

This refers to the current or voltage values needed to shift from the ON → OFF state. The OFF voltage value is the potential difference between each of the input terminals and COM IN.

[Output] signals: BUSY0, RUN/BUSY1, OR0 to 1, GATE0 to 1, ERROR, DO0 to 15, READY0 to 1

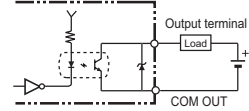
Output voltage	12 to 24 V DC ±10 %
Load current	45 mA max.
ON residual voltage	2 V max.
OFF leakage current	0.2 mA max.
Internal circuit	

I/O Connector

No.	Signal name	Wire color	Mark (red)	Function	No.	Signal name	Wire color	Mark (blk)	Function
A1	COMIN	Orange	■	Common for input signals	B1	RESET	Orange	■	Controller restart
A2	ENCRIG_A1 (*2)	Gray	■	Encoder trigger input (Phase A)	B2	ENCRIG_A0	Gray	■	Encoder trigger input(Phase A)
A3	ENCRIG_B1 (*2)	White	■	Encoder trigger input (Phase B)	B3	ENCRIG_B0	White	■	Encoder trigger input(Phase B)
A4	STEP1 (*2)/ ENCRIG_Z1 (*2)	Yellow	■	Measurement trigger input/ Encoder trigger input (Phase Z)	B4	STEP0/ ENCRIG_Z0	Yellow	■	Measurement trigger input/Encoder trigger input(Phase Z)
A5	DSA1 (*2)	Pink	■	Data send request signal	B5	DSA0	Pink	■	Data send request signal
A6	DI1	Orange	■	Command inputs	B6	DI0	Orange	■	Command inputs
A7	DI3	Gray	■		B7	DI2	Gray	■	
A8	DI5	White	■		B8	DI4	White	■	
A9	DI7	Yellow	■		B9	DI6	Yellow	■	
A10	STGOUT1	Pink	■	Strobe trigger output (*1)	B10	STGOUT0	Pink	■	Strobe trigger output (*1)
A11	STGOUT3	Orange	■	Strobe trigger output (*1)	B11	STGOUT2	Orange	■	Strobe trigger output (*1)
A12	ERROR	Gray	■	ON when there is an error.	B12	RUN/BUSY1 (*2)	Gray	■	ON while in Run mode/ON during processing
A13	COMOUT1	White	■	Common for control signals	B13	BUSY0	White	■	ON during processing
A14	GATE1 (*2)	Yellow	■	ON for the set output time	B14	GATE0	Yellow	■	ON for the set output time
A15	OR1 (*2)	Pink	■	Overall judgment result	B15	OR0	Pink	■	Overall judgment result
A16	READY1 (*2)	Orange	■	ON when image input is allowed	B16	READY0	Orange	■	ON when image input is allowed
A17	COMOUT2	Gray	■	Common for output signals	B17	DO0	Gray	■	Data output
A18	DO1	White	■	Data output	B18	DO2	White	■	
A19	DO3	Yellow	■		B19	DO4	Yellow	■	
A20	DO5	Pink	■		B20	DO6	Pink	■	
A21	DO7	Orange	■		B21	DO8	Orange	■	
A22	DO9	Gray	■		B22	DO10	Gray	■	
A23	DO11	White	■		B23	DO12	White	■	
A24	DO13	Yellow	■		B24	DO14	Yellow	■	
A25	COMOUT3	Pink	■	Common for output signals	B25	DO15	Pink	■	

*Handling the output common terminals

COMOUT1: STGOUT0 to 3, RUN/BUSY1, ERROR, BUSY0, OR0 to 1, GATE0 to 1 COMOUT2: READY0 to 1, DO0 to 7 COMOUT3: DO8 to 15

*1 This is a signal that is used when the strobe device is connected to the Controller.

*2 This signal is only available in the Random trigger mode.

[Input] signals: STEP0/ENCRIG_Z0, STEP1/ENCRIG_Z1,
ENCRIG_A0 to 1, ENCRIG_B0 to 1

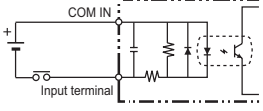
Input voltage	12 to 24 V DC ±10 %
ON current *1	5 mA min.
ON voltage *1	8.8 V min.
OFF current *2	0.5 mA max.
OFF voltage *2	0.8 V max.
ON delay	0.1 ms max.
OFF delay	0.1 ms max.
Internal circuit	

[Output] signals: When STGOUT0-3 are used,
connect the COM IN terminal.

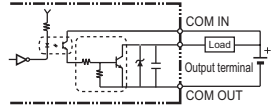
Output voltage	12 to 24 V DC ±10 %
Load current	45 mA max.
ON residual voltage	2 V max.
OFF leakage current	0.2 mA max.
Internal circuit	

■ Parallel Interface

PNP I/O type FZ4-605-10/FZ4-655-10/FZ4-H605-10/FZ4-H655-10/FZ4-705-10/FZ4-755-10/FZ4-H705-10
FZ4-H755-10/FZ4-1105-10/FZ4-1155-10/FZ4-H1105-10/FZ4-H1155-10/FZD-505-10/FZD-555-10

● Internal Specifications

[Input] signals: RESET, DI0 to DI7, DSA0, DSA1

Input voltage	12 to 24 V DC $\pm 10\%$
ON current *1	5 mA min.
ON voltage *1	8.8 V min.
OFF current *2	0.5 mA max.
OFF voltage *2	1.1 V max.
ON delay	5 ms max.
OFF delay	0.7 ms max.
Internal circuit	

[Input] signals: STEP0/ENCTRIG_Z0, STEP1/ENCTRIG_Z1, ENCTRIG_A0 to 1, ENCTRIG_B0 to 1

Input voltage	12 to 24 V DC $\pm 10\%$
ON current *1	5 mA min.
ON voltage *1	8.8 V min.
OFF current *2	0.5 mA max.
OFF voltage *2	0.8 V max.
ON delay	0.1 ms max.
OFF delay	0.1 ms max.
Internal circuit	

*1 ON current/ON voltage

This refers to the current or voltage values needed to shift from the OFF \rightarrow ON state. The ON voltage value is the potential difference between each of the input terminals and COM IN.

*2 OFF current/OFF voltage

This refers to the current or voltage values needed to shift from the ON \rightarrow OFF state. The OFF voltage value is the potential difference between each of the input terminals and COM IN.

[Output] signals: BUSY0, RUN/BUSY1, OR0 to 1, GATE0 to 1, ERROR, DO0 to 15, READY0 to 1

Output voltage	12 to 24 V DC $\pm 10\%$
Load current	45 mA max.
ON residual voltage	2 V max.
OFF leakage current	0.2 mA max.
Internal circuit	

[Output] signals: When STGOUT0-3 are used, connect the COM IN terminal.

Output voltage	12 to 24 V DC $\pm 10\%$
Load current	45 mA max.
ON residual voltage	2 V max.
OFF leakage current	0.2 mA max.
Internal circuit	

● I/O Connector

No.	Signal name	Wire color	Mark (red)	Function	No.	Signal name	Wire color	Mark (blk)	Function
<p>I/O Connector wiring is the same as NPN I/O type.</p>									

●Connector

Connect the optional parallel I/O cable (FZ-VP or FZ-VPX).

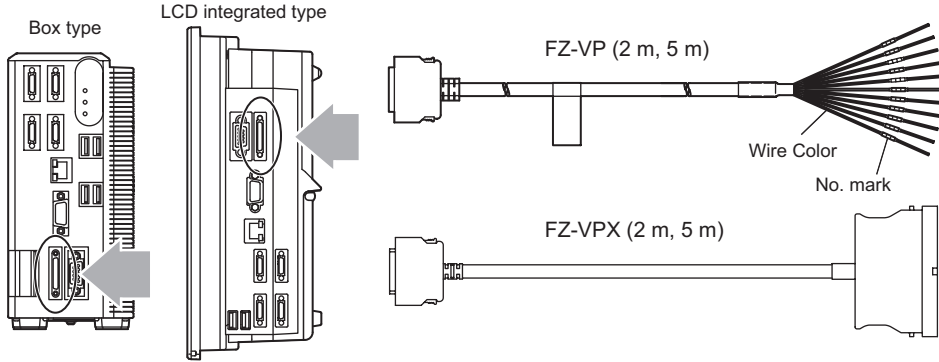

■Serial Interface

●Connector

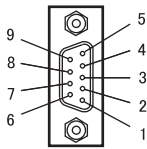

Pin No.	Signal name	Function
1	SDB(+)	For RS-422
2	SD/SDA(-)	For RS-232C/RS-422
3	RD/RDA(-)	For RS-232C/RS-422
4	RDB(+)	For RS-422
5	NC	Not connected
6	NC	Not connected
7	NC	Not connected
8	NC	Not connected
9	GND	Signal ground

Use a compatible connector.

• Recommended items

	Manufacturer	Model
Plug	OMRON Corporation	XM3A-0921
Hood	OMRON Corporation	XM2S-0911

●Wiring

The maximum cable length is 15 m.

• RS-232C

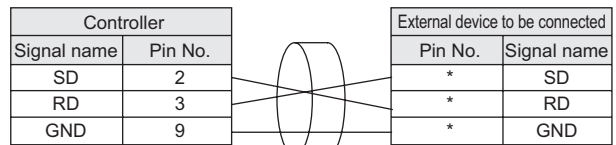

RS/CS control cannot be used.

Use a shielded cable.

• RS-422

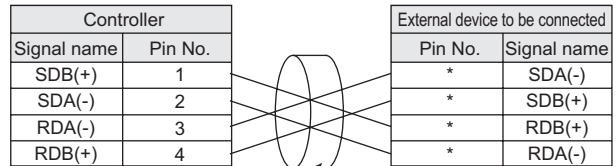

Use a shielded cable.



Pin numbers will depend on the external device being connected. Refer to the manual for the personal computer or PLC being connected.

●Connection Method

Align the connector with the socket and press it straight into place, then fix it with the screws on both sides of the connector.



Turn OFF the power supply before connecting or disconnecting a Cable. Peripheral devices may be damaged if the cable is connected or disconnected with the power ON.

LCD integrated type

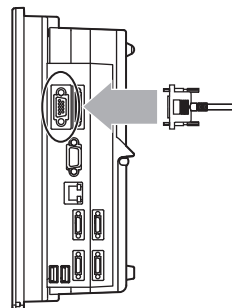

Box type

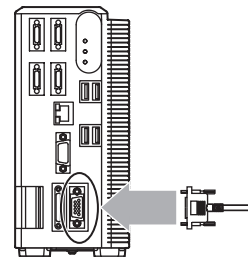

Mounting

● LCD integrated type

• Panel mounting

- ① Make a mount hole on the panel.
Panel thickness range: 1.6 to 4.8 mm
Panel material: Metal (iron, aluminum or stainless)

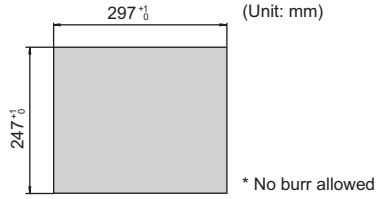

- ② Insert the LCD integrated controller into the hole, from the front panel.

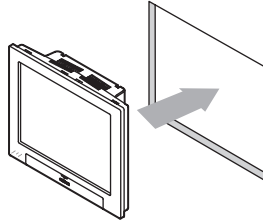

- ③ Use the bracket (supplied with the product) to secure the controller and the panel.

Tightening torque: 0.5 to 0.6 Nm

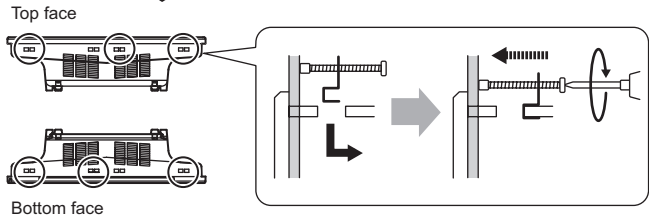

- Mounting the controller to the optional desktop stand.

The controller can be placed on a desk by attaching the optional desktop stand (FZ-DS) to the rear of the controller.

* For details, refer to the instruction manual of the desktop stand.

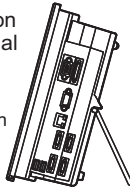

- Mounting the controller to the optional VESA attachment unit.

VESA-compatible mounting of the controller is possible by attaching the optional VESA attachment unit (FZ-VESA) to the rear of the controller.

* For details, refer to the instruction manual of the VESA attachment

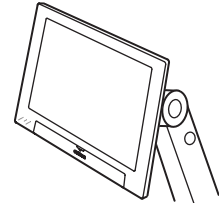

● Box type

• Side mounting

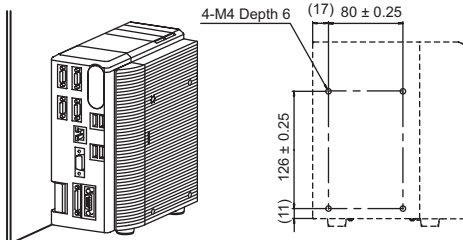

• Bottom mounting

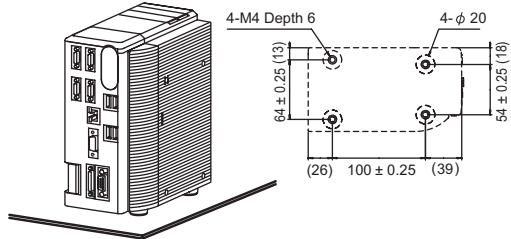

* When mounting the controller on its bottom, it must be fixed without removing the feet to reserve ventilation path.

■ Controller External Dimensions

- LCD integrated type FZ4-600-10/FZ4-605-10/FZ4-H600-10/FZ4-H605-10
FZ4-700-10/FZ4-705-10/FZ4-H700-10/FZ4-H705-10
FZ4-1100-10/FZ4-1105-10/FZ4-H1100-10/FZ4-H1105-10
FZD-500-10/FZD-505-10

(Unit: mm)

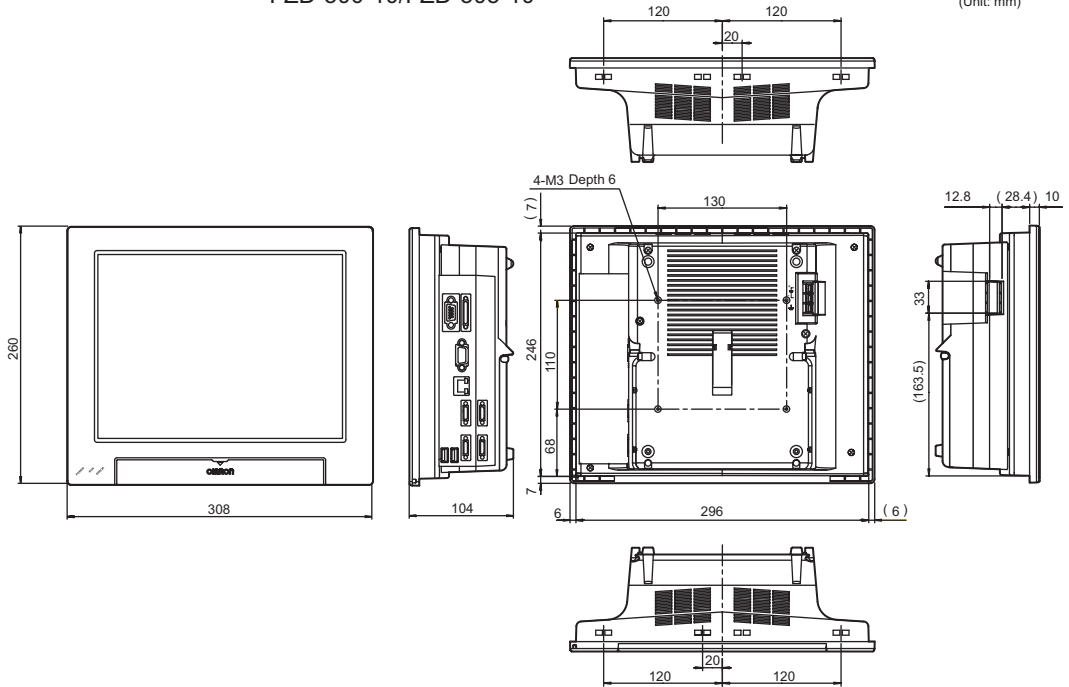

- Box type FZ4-650-10/FZ4-655-10/FZ4-H650-10/FZ4-H655-10
FZ4-750-10/FZ4-755-10/FZ4-H750-10/FZ4-H755-10
FZ4-1150-10/FZ4-1155-10/FZ4-H1150-10/FZ4-H1155-10
FZD-550-10/FZD-555-10

(Unit: mm)

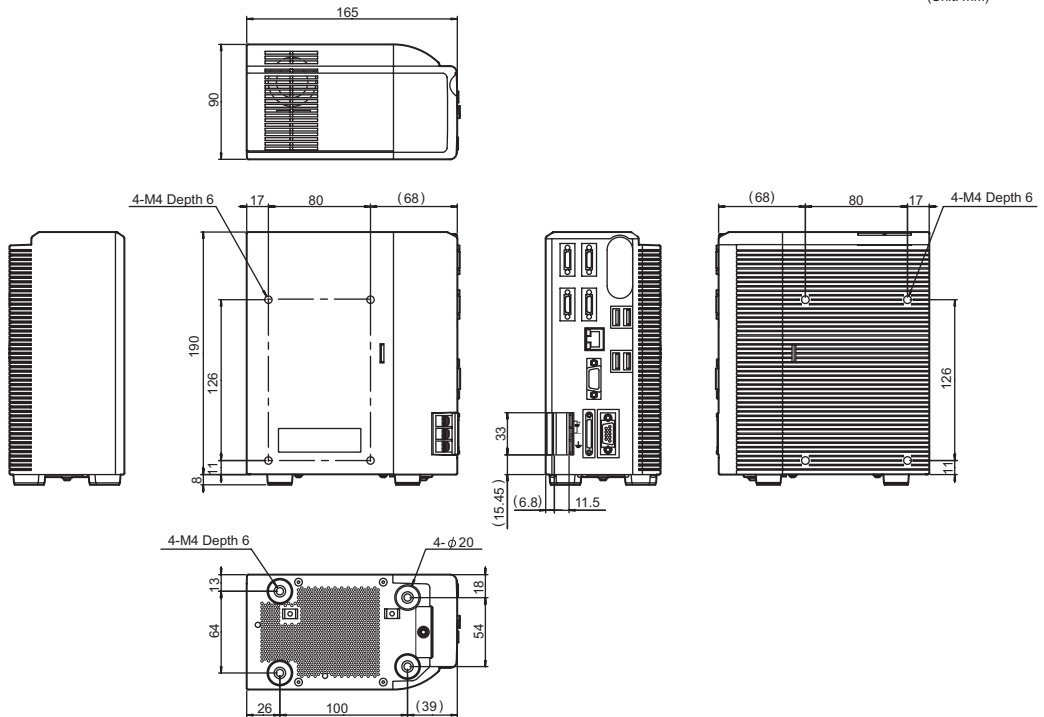

Controller Specifications

Operation	LCD integrated type: Touch pen, mouse etc. BOX type: Mouse or similar device
Serial communications	RS-232C/422: 1 channel
Network communications	Ethernet 100BASE-TX/10BASE-T
EtherNet/IP communication (Exclude FZD)	Use Ethernet port. Transmission speed : 100Mbps(100BASE-TX)
Parallel I/O	17 inputs (RESET, STEP0/ENCTRIG_Z0, STEP1/ENCTRIG_Z1, DSA0 to 1, ENCTRIG_A0 to 1, ENCTRIG_B0 to 1, DI0 to 7) 29 outputs (RUN/BUSY1, BUSY0, GATE0 to 1, OR0 to 1, READY0 to 1, ERROR, STGOUT0 to 3, DO0 to 15)
Monitor interface	LCD integrated type: Integrated Controller and 12.1 inch TFT color LCD (Resolution: XGA 1024×768) BOX type: Analog RGB video output 1 channel (Resolution: XGA 1024×768)
USB interface	4 channels (supports USB1.1 and 2.0)
Power supply voltage	24 V DC (20.4 to 26.4 V DC)
Current consumption (At Power supply voltage 24 V DC)	Consumption of current varies depending on the type of camera connected. When FZ-S_/FZ-S_2M/FZ-S_5M_ is connected: Approx. 4.9 A max. When FZ-SP_/FZ-SF_/FZ-SH_ is connected: Approx. 4.9 A max. When FZ-SLC___/FZ-SZC___ is connected: Approx. 7.5 A max. When FZD-STC2M is connected: Approx. 4.9 A max. When FZ-SQ___ is connected: Approx. 7.5 A max.
Insulation resistance	Between the group of external DC terminals and the ground terminal: 20M Ω min. (DC100V megger, with internal surge absorber removed)
Dielectric strength	Between the group of external DC terminals and the ground terminal: 1,000 VAC, 50/60 Hz
Leakage current	10 mA max.
Noise resistance	2 kV, pulse rise: 5 ns Pulse width: 50 ns Burst continuing time: 15 ms Cycle: 300 ms
Vibration resistance	10 to 150 Hz, one-side amplitude 0.1 mm (Max. acceleration 15m/s ²) 10 times for 8 minutes for each three direction
Shock resistance	150 m/s ² ; 3 times each in 6 directions
Ambient temperature range	Operating: 0 to +50 °C (with no icing or condensation) Ambient temperature specifiable. The cooling fan speed can be switched according to the setting. 0 to +45 °C: Low speed, 0 to +50 °C: High speed Storage: -20 to +65 °C (with no icing or condensation)
Ambient humidity range	Operating and storage: 35 % to 85 % (no condensation)
Ambient environment	No corrosive gases
Ground	D-type ground (ground resistance 100 Ω or less) * conventional class 3 ground
Degree of protection	IEC60529 IP20
Environmental conditions (according to IEC61010-1)	Indoor use Maximum altitude of 2,000 m Supply voltage fluctuations of +10 %, -15 % of the rated voltage Installation category I Pollution degree 2
Case materials	ABS
Weight	LCD integrated type: Approx. 3.4 kg Box type: Approx. 1.9 kg

OMRON Corporation Industrial Automation Company
Tokyo, JAPAN

Contact: www.ia.omron.com

Regional Headquarters

OMRON EUROPE B.V.

Sensor Business Unit

Carl-Benz-Str. 4, D-71154 Nufringen, Germany
Tel: (49) 7032-811-0/Fax: (49) 7032-811-199

OMRON ASIA PACIFIC PTE. LTD.

No. 438A Alexandra Road # 05-05/08 (Lobby 2),
Alexandra Technopark,
Singapore 119967
Tel: (65) 6835-3011/Fax: (65) 6835-2711

OMRON ELECTRONICS LLC

One Commerce Drive Schaumburg,
IL 60173-5302 U.S.A.
Tel: (1) 847-843-7900/Fax: (1) 847-843-7787

OMRON (CHINA) CO., LTD.

Room 2211, Bank of China Tower,
200 Yin Cheng Zhong Road,
PuDong New Area, Shanghai, 200120, China
Tel: (86) 21-5037-2222/Fax: (86) 21-5037-2200

Authorized Distributor:

In the interest of product improvement,
specifications are subject to change without notice.