

# F350-U007E

## Rotation Positioning Software 1

### Operation Manual

*Produced March 1997*





## **OMRON Product References**

All OMRON products are capitalized in this manual. The word “Unit” is also capitalized when it refers to an OMRON product, regardless of whether or not it appears in the proper name of the product.

## **Visual Aids**

The following headings appear in the left column of the manual to help you locate different types of information.

**Important** Indicates information of importance that, if not heeded, could result in damage to the product, malfunction, or incorrect operation.

**Note** Indicates information of particular interest for efficient and convenient operation of the product.

**1, 2, 3...** 1. Indicates lists of one sort or another, such as procedures, checklists, etc.

### **© OMRON, 1997**

All rights reserved. No part of this publication may be reproduced, stored in a retrieval system, or transmitted, in any form, or by any means, mechanical, electronic, photocopying, recording, or otherwise, without the prior written permission of OMRON.

No patent liability is assumed with respect to the use of the information contained herein. Moreover, because OMRON is constantly striving to improve its high-quality products, the information contained in this manual is subject to change without notice. Every precaution has been taken in the preparation of this manual. Nevertheless, OMRON assumes no responsibility for errors or omissions. Neither is any liability assumed for damages resulting from the use of the information contained in this publication.

## **Symbols**

The following symbols appear at the bottom of each page in *Section 4 Functions and their Operation* and indicate the measurement items that apply to a particular menu operation.

**Rotation Positioning**

Indicates information for using rotation positioning.

**Position Compensation**

Indicates information for using position compensation.

## **Menu Item Notation**

Menu items are sometimes abbreviated on the menu bar due to space limitations. In this manual, the non-abbreviated form of the menu items are used and, if an abbreviation is displayed on the menu bar, the characters that are actually displayed are underlined. If no characters are underlined, then the menu item is not abbreviated on the display.

For example, "O.Position compensation" appears on the menu display as "O.Posi cmp" and is given in this manual as "O.Position compensation"

# TABLE OF CONTENTS

<b>SECTION 1</b>	
<b>Introduction</b> .....	<b>1</b>
1-1 Before Using this Manual .....	2
1-2 Applicable Manuals .....	3
1-3 Features .....	4
<b>SECTION 2</b>	
<b>Preparation for Operation</b> .....	<b>7</b>
2-1 System Configuration .....	8
2-2 Starting and Quitting an Application Program .....	10
2-3 Basic Menu Operation .....	14
<b>SECTION 3</b>	
<b>Using the Menus</b> .....	<b>21</b>
3-1 Rotation Positioning .....	22
<b>SECTION 4</b>	
<b>Functions and their Operations</b> .....	<b>31</b>
<b>■ Settings</b>	
4-1 S.Scene .....	33
4-2 D.Display .....	36
4-3 U.Process .....	38
4-4 C.Camera .....	43
<b>■ Rotation Positioning</b>	
4-5 P.Rotation Positioning .....	60
4-6 M.Measure/O.Measure Monitor .....	85
<b>■ Position Compensation</b>	
4-7 P.Position Compensation .....	90
4-8 M.Measure/O.Measure Monitor .....	121
<b>■ Measurements</b>	
4-9 M.Measure/M.Measure .....	124
<b>■ System</b>	
4-10 Y.System .....	137
<b>SECTION 5</b>	
<b>Troubleshooting</b> .....	<b>143</b>
<b>Appendices</b>	
A Menu Hierarchy Diagrams .....	147
B Scene Data Size .....	151
<b>Index</b> .....	<b>153</b>
<b>Revision History</b> .....	<b>157</b>

## ***About this Manual:***

This manual describes the operation of the F350-U007E Rotation Positioning Software 1 and includes the sections described below. The F350-U007E Rotation Positioning Software 1 is a software package used with the F350 Visual Inspection System.

Please read this manual carefully and be sure you understand the information provided before attempting to operate the F350-U007E Rotation Positioning Software 1.

**Section 1** provides a general introduction to the F350-U007E Rotation Positioning Software 1.

**Section 2** describes the system configuration, starting and quitting the software, and basic menu operations.

**Section 3** explains the functions and operations in order of the F350-U007E Rotation Positioning Software 1, using typical inspections as examples.

**Section 4** provides detailed explanations of the functions and their usage.

**Section 5** provides a list of error messages, and the causes and remedies for them.

The **Appendices** provide a menu hierarchy diagram for the software and methods for calculating scene data sizes.



**WARNING** Failure to read and understand the information provided in this manual may result in personal injury or death, damage to the product, or product failure. Please read each section in its entirety and be sure you understand the information provided in the section and related sections before attempting any of the procedures or operations given.

# SECTION 1

## Introduction

This section provides a general introduction to the F350 Rotation Positioning Software 1.

1-1	Before Using this Manual .....	2
1-2	Applicable Manuals .....	3
1-3	Features .....	4

## **1-1 Before Using this Manual**

### **Copyright**

The copyright of this software (the stored and written contents of the system memory card and operation manual) belongs to OMRON Corporation.

### **Copying and Modifications**

This software may not be copied in whole or in part, except for the purposes of storage or for changes or modifications for the customer's own use.

This software may be changed or modified only for the customer's own use. OMRON, however, accepts no responsibility for problems or damages arising from customer changes or modifications to the software.

### **Handling the System Memory Card**

Do not leave the system memory card in dusty or wet locations as this may cause connection errors. To prevent destruction of system program data or deformation of the card, avoid high temperatures, high humidity, and direct sunlight. Also, do not bend, scratch or apply shock to the card.



## 1-2 Applicable Manuals

The manuals used with the F350 Visual Inspection System are shown in the following table. Manuals are listed according to the steps involved in setting up and operating a system.

The following three manuals are used with the F350 Visual Inspection System. The first and last manual are used with all systems. The second manual depends on the applications software that is being used.

- F350 Setup Menu Operation Manual: Included with the F350-C12E/C41E IMP Unit.
- F350 Application Software Operation Manual: Included with the Application Software (F350-U□□□E).
- F350 OVL Reference Manual: Included with F350-L12E OVL Unit.

Procedure		Manual	
		Application Program	OVL program
System design	Consider the lighting, I/O devices, and so on, and determine the system configuration. Design the system carefully, taking into account variations in conditions and the objects that are to be inspected/read.	F350-series Data Sheet	
Assembly/Installation	Install the F350 Visual Inspection System by assembling the hardware and wiring the power supply and peripheral devices.	F350 Setup Menu Operation Manual	
Software settings	Start up the software and make the settings for the F350 Visual Inspection System and the settings for starting the software, communicating with I/O devices, and so on.	Make the settings using the Setup Menu, which is standard with F350-C12E/C41E IMP Unit. (Refer to the F350 Setup Menu Operation Manual.)	Mount the F350-L12E OVL Unit and program using OVL, a specialized BASIC programming language. (Refer to the F350 OVL Reference Manual.)
Inspection/Reading condition settings	Start up the software and make the inspection/reading settings. Set the criteria for determining the inspection/read area and the acceptability of the inspected products.	Make the settings using the F350-U□□□E Application Program. Do actual testing according to the conditions that have been set. (Refer to the relevant F350 operation manual.)	Mount the F350-L12E OVL Unit and program using OVL, a specialized BASIC programming language. Do actual testing according to the conditions that have been set. (Refer to the F350 OVL Reference Manual.)
Testing/Inspection/Reading	Do actual testing for the conditions that have been set. If adjustments are required, change the settings.		
Maintenance	Carry out periodic inspections. This is essential in order to maintain the F350 Visual Inspection System in optimum operating conditions.	F350 Setup Menu Operation Manual	

## 1-3 Features

Rotation Positioning Software 1 allows high accuracy positioning of printed circuit boards and products.

- Positioning is possible using any of the following configurations: 1 camera/1 model, 1 camera/2 models or 2 cameras/1 model per camera. High accuracy positioning is possible by dividing the field of view.
- The two-model pairing function enables high-speed position detection, which includes rotation, even for circular parts.
- Positions can be detected in subpixel units using unique gray processing.
- Measured results can be retrieved in real coordinates using a calibration setting.
- High-accuracy positioning is possible using distortion compensation (to correct lense distortion).

Detection of the angle of rotation of a CD.

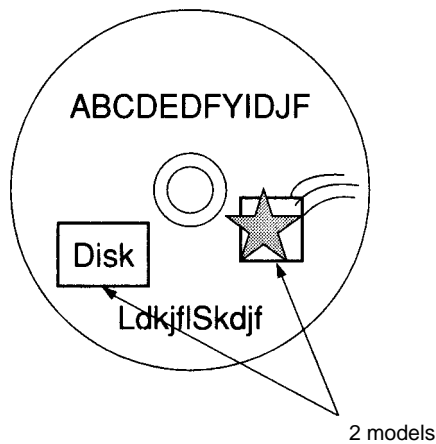

Positioning a wheel

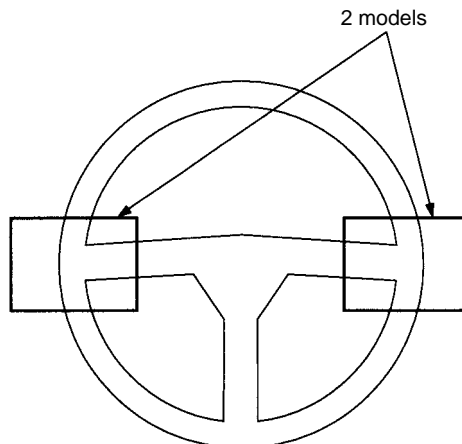

Positioning bare chips

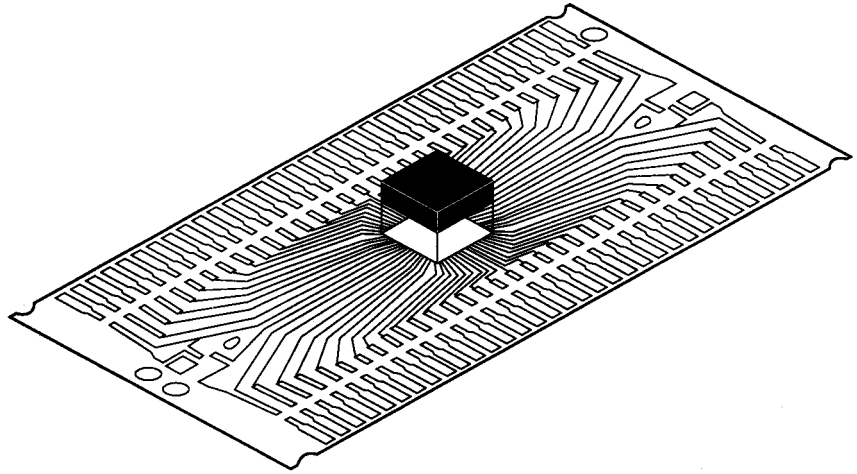

Two-camera positioning

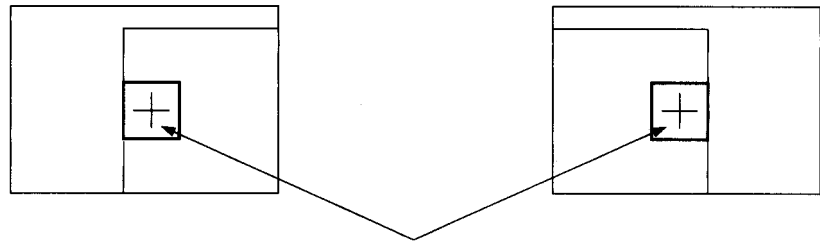

Positioning is executed from two fields of vision and the displacement in the center of gravity and the inclination are output.

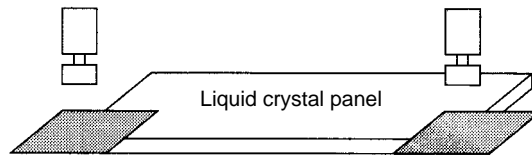

# SECTION 2

## Preparation for Operation

This section describes the system configuration, starting and quitting the Application Program, and basic menu operation.

- 2-1 System Configuration ..... 8
- 2-2 Starting and Quitting an Application Program ..... 10
  - 2-2-1 Starting ..... 10
  - 2-2-2 Quitting ..... 13
- 2-3 Basic Menu Operation ..... 14
  - 2-3-1 About the Console ..... 14
  - 2-3-2 Key to the Screens ..... 15
  - 2-3-3 Selecting a Menu ..... 15
  - 2-3-4 Inputting Settings ..... 16
  - 2-3-5 Inputting Numbers ..... 17
  - 2-3-6 Inputting Characters ..... 18

## 2-1 System Configuration

The numbers of cameras and the types of I/O devices that can be used depends on the application software. Check that the system is correctly configured for the application software.

### Basic System Configuration (Must be used.)

**F300-P2,  
★ F300-P2E  
Power Supply Unit**  
Supplies power to the entire system.

(Important: The F200-P Power Supply Unit cannot be mounted because its capacity is too small.)



★ **F350-C12E,  
F350-C41E IMP Unit**  
Processes images.

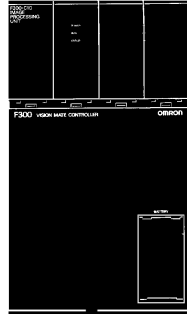

★ **F300-FM2 MMI Unit**  
Provides Memory Card functions and menu operations via a Video Monitor and Console.

★ **F300-KP Console**    **F300-M09 Video Monitor (100 VAC)**

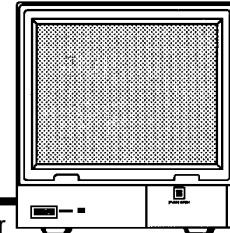
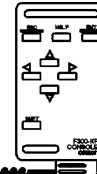

★ **F309-VM Monitor Cable**

★ **F300-B32 (3 slots)**

★ **F300-B52 (5 slots)**

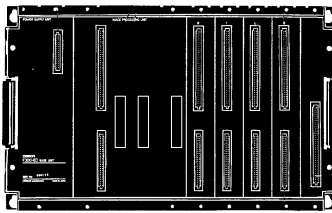

or

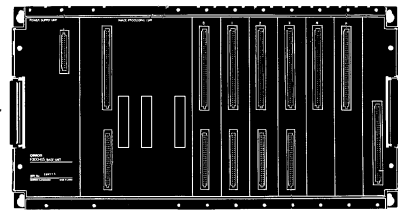

### Camera I/F Units (use four maximum)



**F300-A20 Normal Camera I/F Unit**  
For measuring stationary objects or moving objects using a strobe.



★ **F300-A22S Normal Simultaneously Camera I/F Unit**  
For measuring stationary objects or moving objects using a strobe, and for measuring two places simultaneously using two cameras.



**F300-A20R Shutter Camera I/F Unit**  
For measuring objects moving at high speed.



★ **F300-A22RS Shutter Simultaneously Camera I/F Unit**  
For measuring objects moving at high speed, and for measuring two places simultaneously using two cameras.



**F300-A23RS Frame Shutter Camera I/F Unit**  
This I/F Unit is used exclusively with the F300-S4R. For measuring objects moving at high speed, and for measuring two places simultaneously using two cameras.

★ **F309-VSR2 Camera Cable**

★ **F309-VSR2 Camera Cable**

★ **F309-VSR2 Camera Cable**

**F200-S Camera**

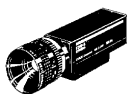

★ **F300-S Camera**

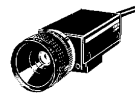

★ **F300-S2R Shutter Camera**



**F300-S3DR Shutter Camera**



**F300-S4R Frame Shutter Camera**



· Lens

· Light

### Cameras (use eight maximum) Only one F200-S Camera can be used.

- Important**
1. An incorrect image may be read if different types of cameras and I/F Units are used together. Do not mix different types of cameras and I/F Units.
  2. Strobes cannot be used when an F200-S Camera is used for inspection.

Some of the products listed may not be available overseas. Please contact your nearest OMRON sales office by referring to the addresses provided at the back of this manual.

**Note** A star (★) before a model number indicates conformance to the EC Directives. Use only these Units when constructing a system that must conform to EC Directives. Refer to Appendix A in the Setup Manual for a complete list of the Units that conform to EC Directives.

**F350-U007E Rotation Positioning Software 1**  
Rotation positioning program

**Peripheral Devices**

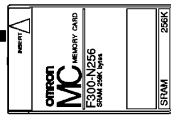

★ **F300-N256/N512/N2M Memory Card**  
Use to store scene data. In addition, a Memory Card is required to back up scene data when using multiple scenes with an F350-C12E IMP Unit.

**I/F Units (Use one that matches the peripheral devices connected.)**



★ **F300-E2 RS-232C I/F Unit**  
Used to input instructions through the RS-232C interfaces provided on this Unit. All input operations must be performed from the measurement screen.



★ **F300-D2 Terminal Block Unit**  
Used to input instructions and output measurement results through the terminal block provided on this Unit. All input and output operations must be performed from the measurement screen.



★ **F300-DC2 Parallel I/O Unit**  
Used to input instructions and output measurement results through the parallel I/O interface provided on this Unit. All input and output operations must be performed from the measurement screen.



**F300-FS Strobe I/F Unit**  
Use to take images while using a strobe light.

**Note**  
Either one or two Strobe I/F Units can be mounted. All connected strobe lights flash while the application software is being operated. For details regarding strobe flash timing, refer to 4-2-1 *Selecting the Image Display Method*.



★ **F300-G Dummy Unit**  
Use to insert into empty slots to protect and connectors and maintain external strength and appearance.

★ F309-VR  
RS-232C Cable

**IBM PC/AT or compatible**

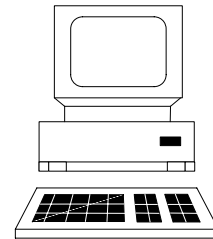

**C200H or CQM1 Programmable Controller**

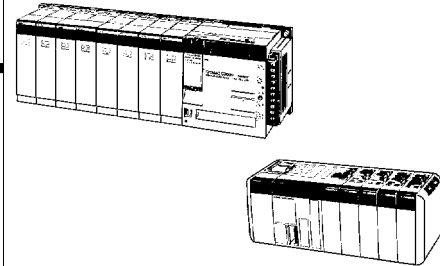

**Synchronization Sensor**

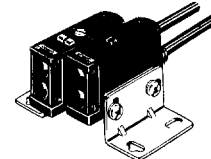

**3Z4S-LT DSX-240 Strobe Device (100 VAC)**

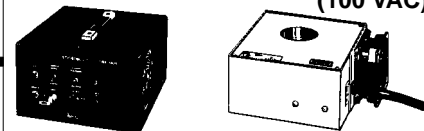

F309-VFS  
Strobe Cable

## 2-2 Starting and Quitting an Application Program

### 2-2-1 Starting

The application program contains two different measurement items: Position compensation, Rotation positioning.

Once the application program has been started, you will need to set the order in which to execute measurement items and the conditions for executing each.

Measurement item	Description
Position compensation	The position of the measured object can be compensated so that the measurement location does not fall outside of the search region.
Rotation positioning	Positioning of measurement objects can be executed according to the rotation angles and position of marks. Measured results are output to an RS-232C Unit or a Parallel I/O Unit.

The Setup Menu is used to install and run an Application Program. Operate the Setup Menu by referring to 3-1 *Starting the Setup Menu* in the *F350 Setup Menu Operation Manual*.

When an Application Program is installed, any previously installed software and data are deleted from memory. In addition, when an F350-C41E IMP Unit is used, all of the data saved to the RAM disk is deleted. Save this data in advance, if it is required. Refer to 5.3 *B.Backup* in the *F350 Setup Menu Operation Manual*.

#### Procedure

- 1, 2, 3...
1. Select "I.Installation."
  2. Select "M.Application program (memory card)." The Application Program directory will be displayed.

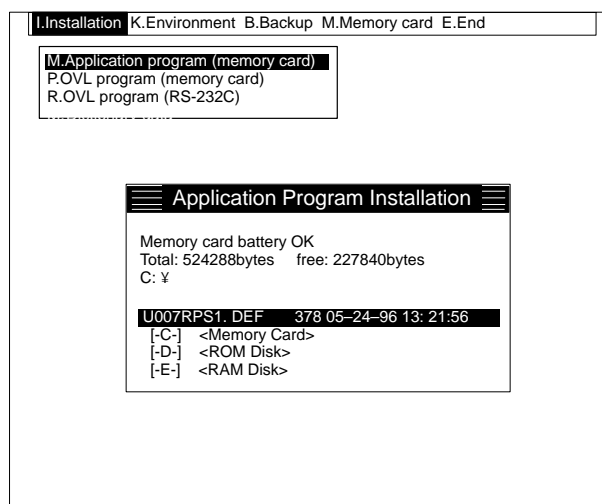

3. Select the filename. A confirmation message will be displayed.

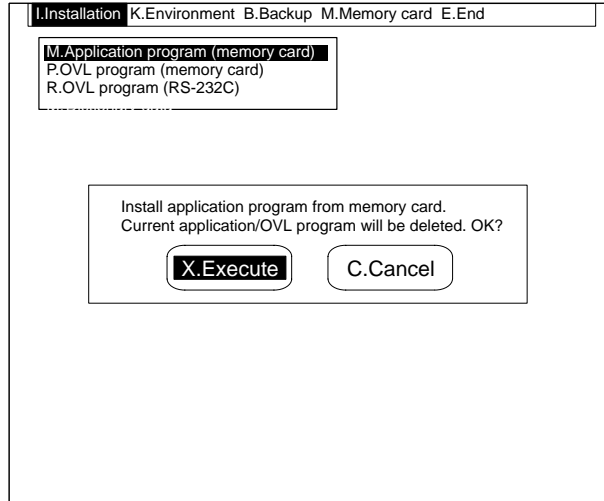

4. Select "X.Execute." The Application Program will be installed. A confirmation message will be displayed when installation is complete.

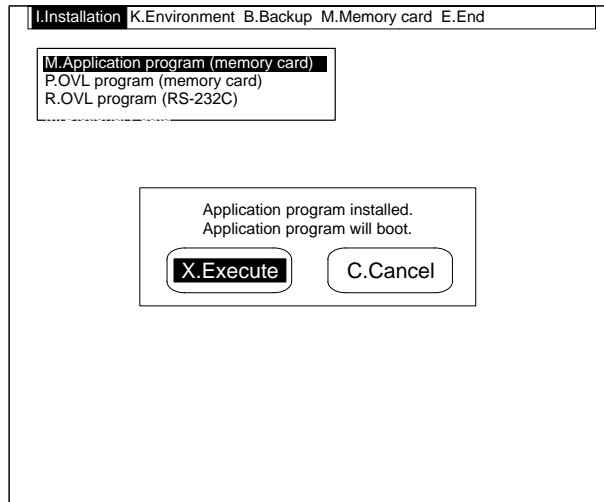



- 5. Select "X.Execute." The Application Program will be started. Set the measurement items to be installed to ON and select "E.End."

The Initial Screen is shown below.

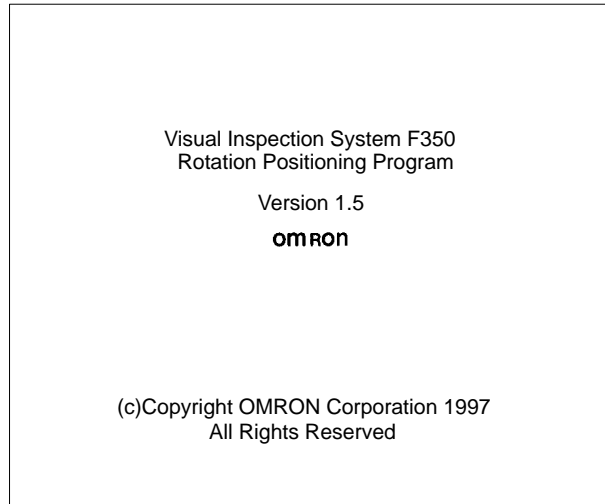

If the F350-C41E is being used, a message will be displayed to confirm whether the RAM disk is to be initialized. Select "O.OK."

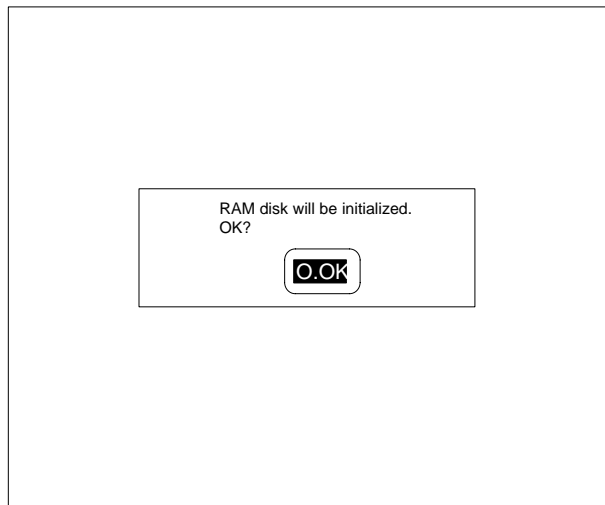

6. The Application Program Basic Screen and the image from the connected camera 0 will be displayed.

Adjust the image focus.

If multiple cameras are connected, select the image from the camera to be adjusted. Refer to *4-4-1 Selecting the Camera Number*.

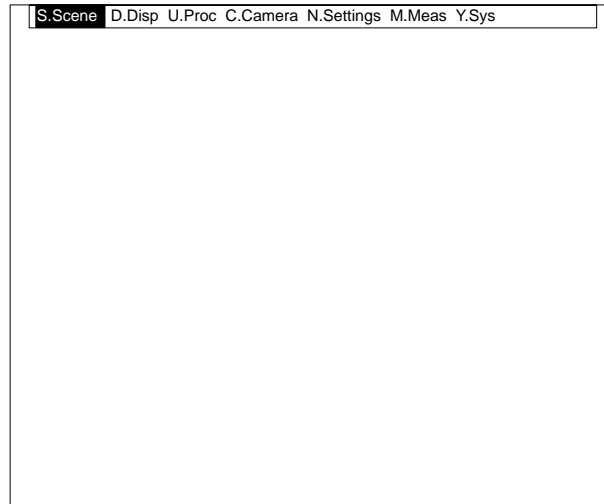

**Important** Do not turn off the power during installation. If power is turned off during these operations, memory contents will be destroyed and the F350 will malfunction when it is turned on again.

Once installed, the Application Program will run each time the power is turned on. Select "K.Environment" and "M.Initial Mode" in the Setup Menu to change the program which runs initially. Refer to *5-2-1 Designating Startup Operations: M.Initial mode* in the *F350 Setup Menu Operation Manual*.

## 2-2-2 Quitting

**Important** Do not turn off the power during the following operations. If power is turned off during these operations, memory contents will be destroyed and the F350 will malfunction when it is turned on again.

- While data is being saved, loaded, or copied.
- While the orange memory card access indicator on the MMI Unit is lit.
- While the model is being registered.

### Procedure

- 1, 2, 3...**
1. Turn off the F350 power.
  2. Turn off the video monitor power.
- Data settings are stored when the F350 is turned off.

- Note**
- 1) The Setup Menu and OVL system cannot be started from the Application Program. Quit the Application Program before starting the Setup Menu or OVL system.
  - 2) To run the Setup Menu, turn on the power while holding down the Enter Key. Refer to *3-1 Starting the Setup Menu* in the *F350 Setup Menu Operation Manual*.
  - 3) To start the OVL system, run the Setup Menu, change the "K.Environment/ M.Initial Mode" to "OVL prompt," and restart the F350. Refer to *2-2-1 Starting Up* in the *F350 OVL Reference Manual*.

## 2-3 Basic Menu Operation

The Application Program is operated from the Console.

### 2-3-1 About the Console

The names of the various Console parts and their functions are described below. Only the basic key functions are described here. Some of them are assigned special functions in some of the menus. Special key functions are described on the comment line of the screen.

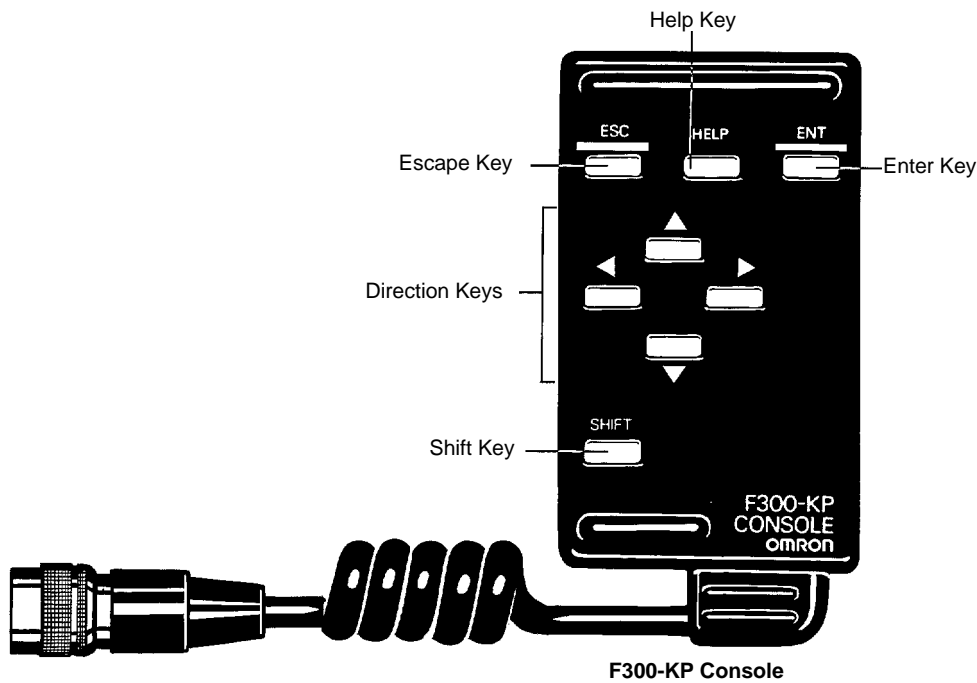

Marking	Name	Function
ESC	Escape Key	Interrupts processing and displays the previous menu level.
HELP	Help Key	Assigned a different function for each menu.
ENT	Enter Key	Executes the function at the cursor position. If a menu is displayed, the next menu level at the cursor position will be displayed. Sets input data when settings are being made.
▲ ▼	Direction Keys	Move the cursor up and down. In numerical input mode, the Direction Keys increase or decrease a number by 1.
▶ ◀		Move the cursor left and right.
SHIFT	Shift Key	Has no effect when pressed alone but changes the function of other keys pressed simultaneously. The menus assign functions to combinations of the Shift Key with other keys.
Example: SHIFT+ESC		Displays the extended menu, if any exists.

### 2-3-2 Key to the Screens

The menus and their functions are described below.

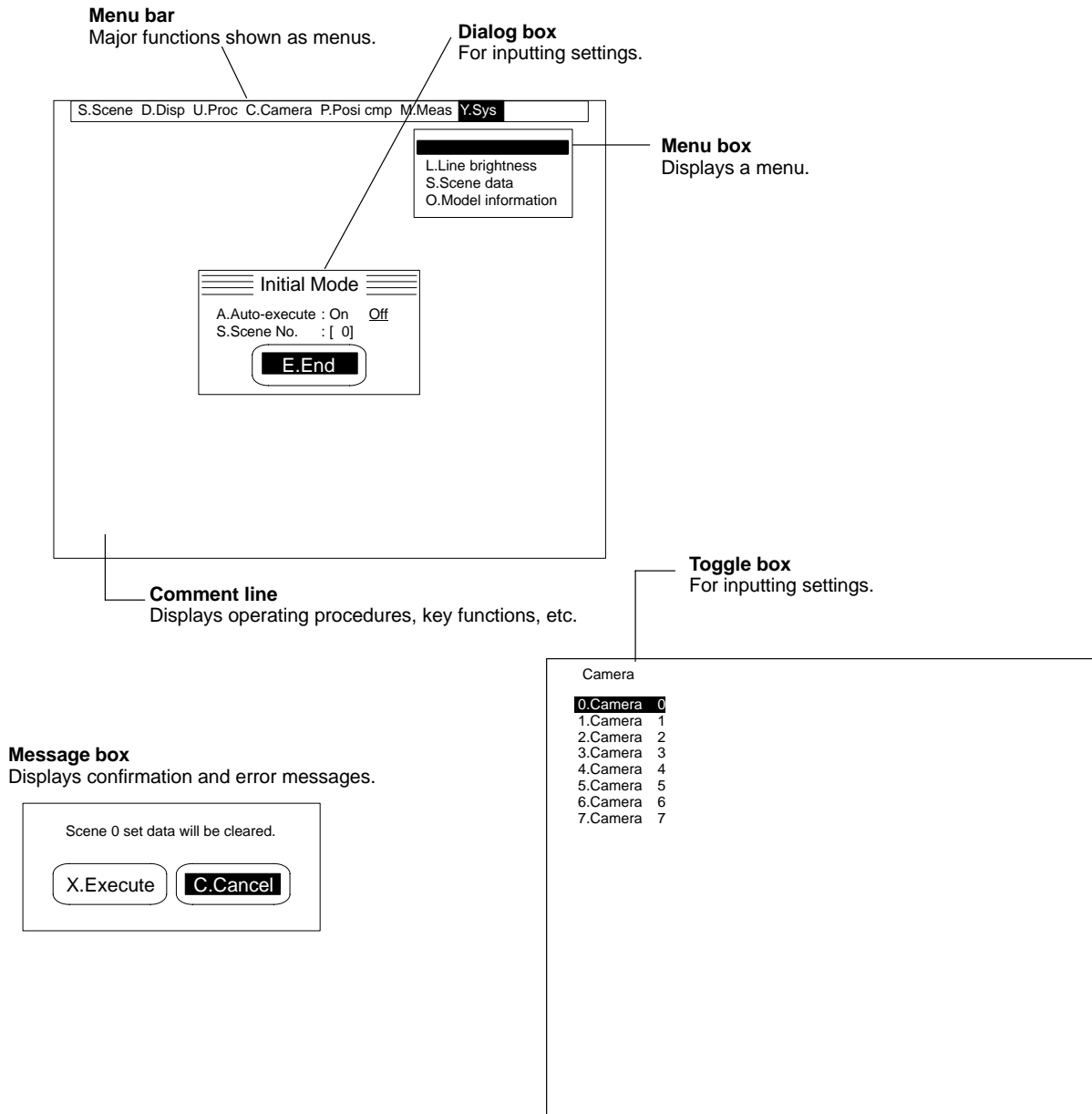

### 2-3-3 Selecting a Menu

The Application Program is hierarchical and it is necessary to select related menus to set data. Select the appropriate menu for operations such as setting data or executing measurements. Refer to the menu hierarchical diagram in *Appendix A* to determine the overall menu hierarchy.

**Procedure**

- 1, 2, 3... 1. Move the cursor to the required menu item and press the Enter Key. The next level in the menu hierarchy will be displayed. Repeat the procedure to move down another level.

2. Press the Escape Key. The previous level in the menu hierarchy will be displayed. Press the Escape Key again to move up another level.

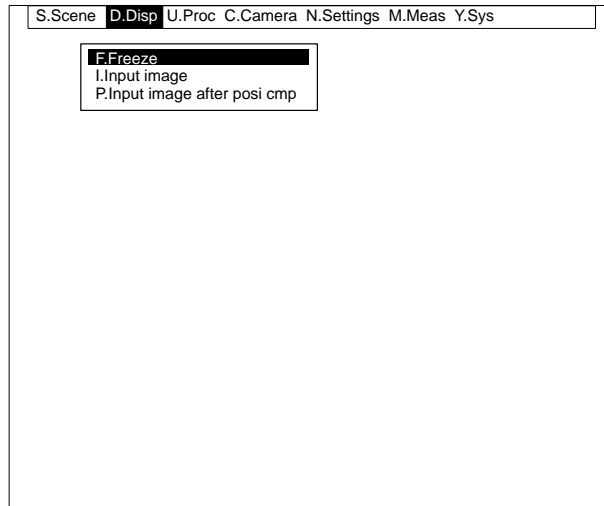

### 2-3-4 Inputting Settings

Dialog boxes and toggle boxes are both used on data setting screens. Dialog boxes allow multiple data settings to be made simultaneously when “E.End” is selected. Toggle boxes, however, allow one setting to be selected from several possibilities.

All settings are set to default values at the factory. Change the settings as required.

#### Settings in Dialog Boxes

The current settings are underlined when a dialog box is displayed.

#### Procedure

- 1, 2, 3... 1. Press the Up/Down Keys to move the cursor to the setting to be changed. The cursor will move to the current setting.

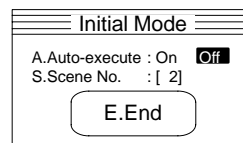

2. Press the Right/Left Keys to move the cursor to the required data setting.

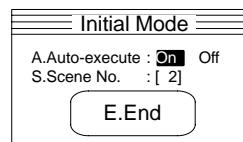

3. Move the cursor to “E.End” and press the Enter Key. The selected setting will be input into the system.

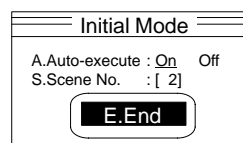

**Settings in Toggle Boxes**

The cursor will be at the current data setting when a toggle box is displayed.

**Procedure**

- 1, 2, 3... 1. Move the cursor to the required new data setting and press the Enter Key. The selected setting will be input into the system.

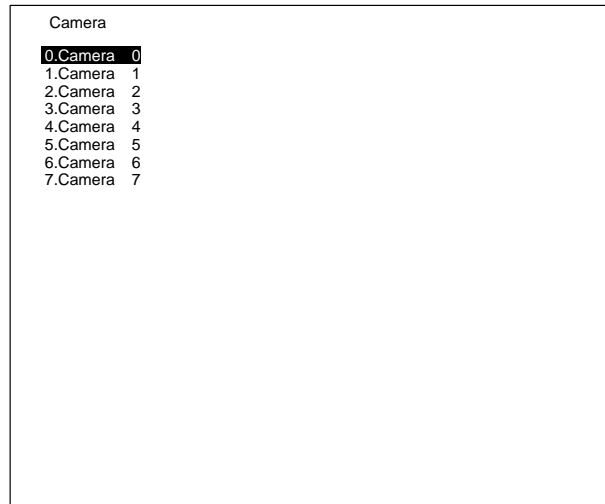

**2-3-5 Inputting Numbers**

The method for inputting numbers to set scene numbers and evaluation criteria is described below. All settings are set to default values at the factory. Change the settings as required.

**Procedure**

- 1, 2, 3... 1. Move the cursor to the item for which a number is to be input and press the Enter Key. The number input mode will be entered.

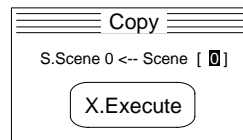

2. Move the cursor to the digit to be changed.

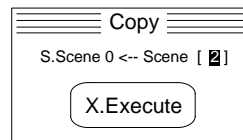

3. Press the Up/Down Keys to increase or decrease the number.

**Entering a Minus Sign (-)**

Move the cursor to the extreme left position and press the Up/Down Keys to display the minus sign.

Repeat steps 2 and 3 above to input multiple values.

4. Press the Enter Key. The value will be input into the system.

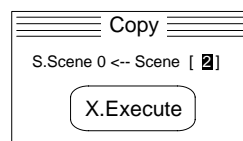

A convenient method exists for fine adjustment of a number. Move the cursor to the number to be changed and press the Direction Keys shown in the following table.

Key	Action
▶	Increases the least-significant digit by one.
◀	Decreases the least-significant digit by one.

### 2-3-6 Inputting Characters

The method for inputting characters for file names or scene comments is described below. Characters can be input by selecting them from the following character table.

A	B	C	D	E	F	G	H	I	J	K	L	M
N	O	P	Q	R	S	T	U	V	W	X	Y	Z
0	1	2	3	4	5	6	7	8	9	-	-	
!	#	\$	%	&	'	(	)	^	'			
DEL	BS	INS	←→	END								

The displays other than characters have the functions described below.

Display	Action
DEL	Deletes the character at the cursor position.
BS	Deletes the character immediately to the left of the cursor position.
INS	Toggles between insert and overwrite modes. The initial setting is overwrite.
←	Moves the cursor to the left.
→	Moves the cursor to the right.
END	Ends the character input operation.

#### Procedure

- 1, 2, 3...
1. Move the cursor to the item for which a character is to be input and press the Enter Key. The character input mode will be entered, and the characters that can be input will be displayed on the screen.

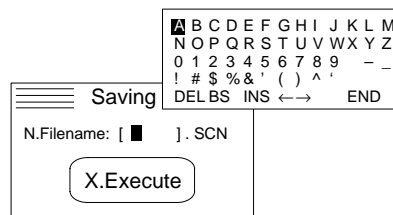

2. Move the cursor to the character that is to be input.

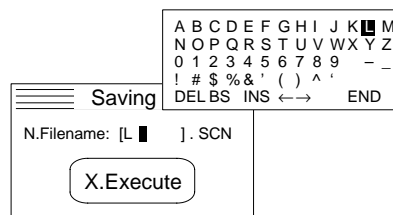

3. Press the Enter Key to input the character. Repeat steps 2 and 3 above to input multiple characters.

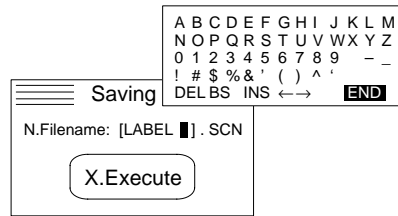

4. When all the characters have been input, move the cursor to "End" and press the Enter Key. The character input mode will be quit, and the input characters will be set.

**Clearing All Characters**

To clear all characters, press the Shift and Enter Keys while in the character input mode.

**Inserting Characters**

"INS" can be used to toggle between the insert and overwrite modes. An underline will be displayed while in the insert mode, and the cursor will be displayed while in the overwrite mode.



# SECTION 3

## Using the Menus

This section describes the two measurement items in the F350 Rotation Positioning program. Select the measurement items that are suitable for the objects being inspected. This section explains the functions and operations in order, using typical measurements as examples.

3-1	Rotation Positioning .....	22
-----	----------------------------	----

### 3-1 Rotation Positioning

The rotation positioning program can be used, for example to detect the angle of rotation of a CD and position the CD accordingly. The measured results are changed to actual dimensions and then output to the Parallel I/O Unit. When the objects reach the measurement position, a STEP signal is input from a synchronization sensor.

The F350 carries out measurements in sync with the STEP signal.

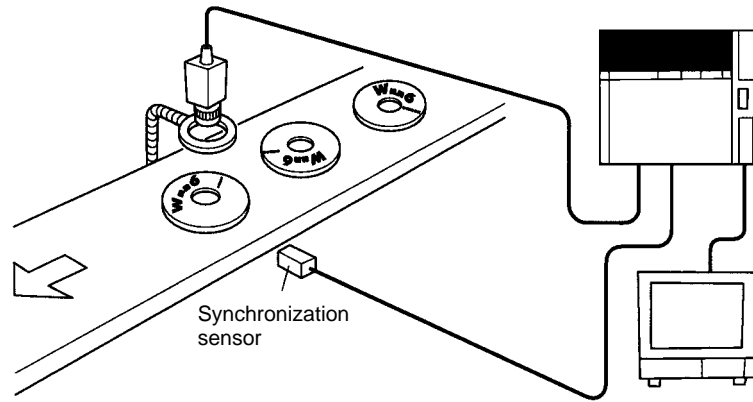

**Procedure**

**Selecting the Scene Number**

- 1, 2, 3... 1. Select scene 0. Subsequent data settings will apply to scene 0. Refer to 4-1-1 Selecting the Scene Number.

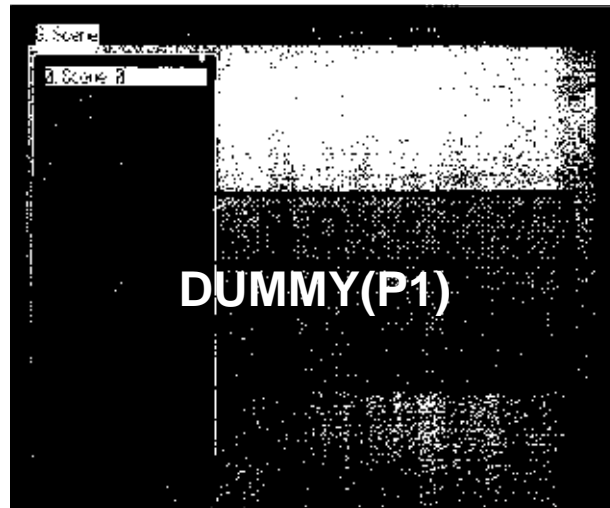

**Setting Processes**

2. Set position compensation for process number 0.
3. Set rotation positioning for process number 1. Refer to 4-3-1 *Setting Measurement Items*.

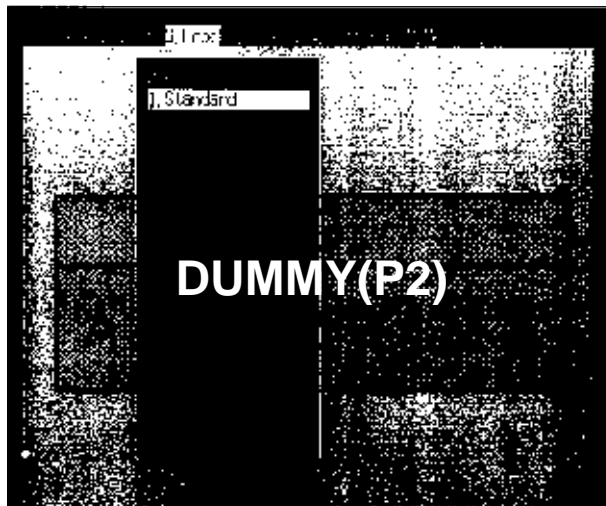
**Setting Position Compensation**

4. Select "0.Position compensation" under "U.Process."  
"P.Position compensation" will be displayed on the menu bar. Refer to 4-3-2 *Switching Processes*.

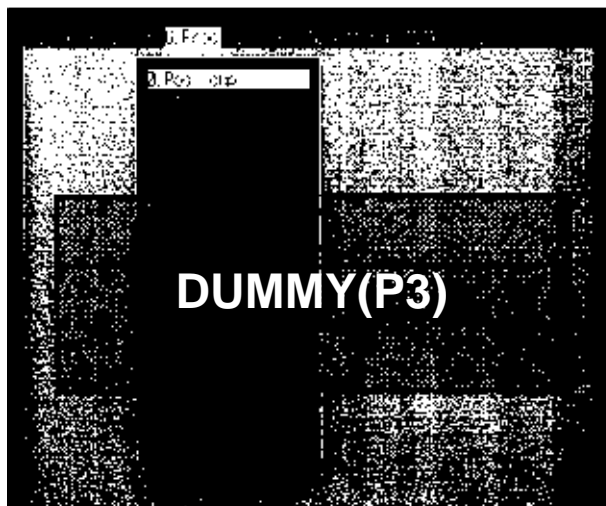

5. Select camera 0. Refer to 4-4-1 *Selecting the Camera Number*.

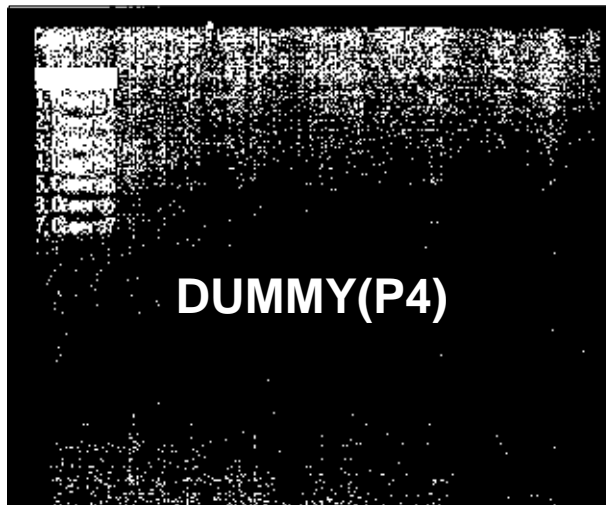

6. Select the position compensation method. In this case, circle positioning. Refer to 4-7-1 *Selecting the Position Compensation Mode*.

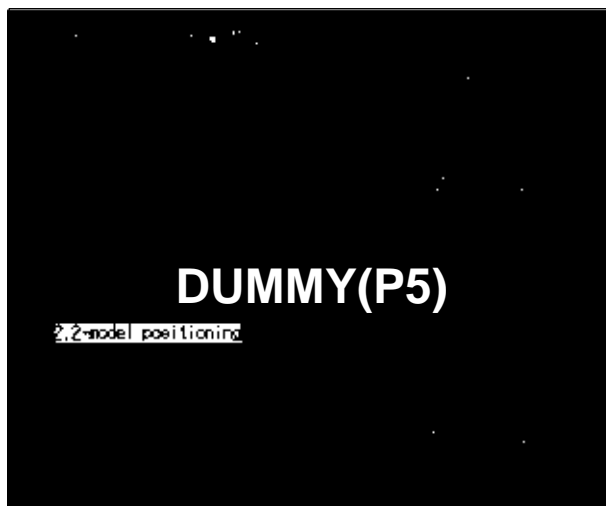

7. Register the position compensation model. Refer to 4-7-1 *Selecting the Position Compensation Mode*.

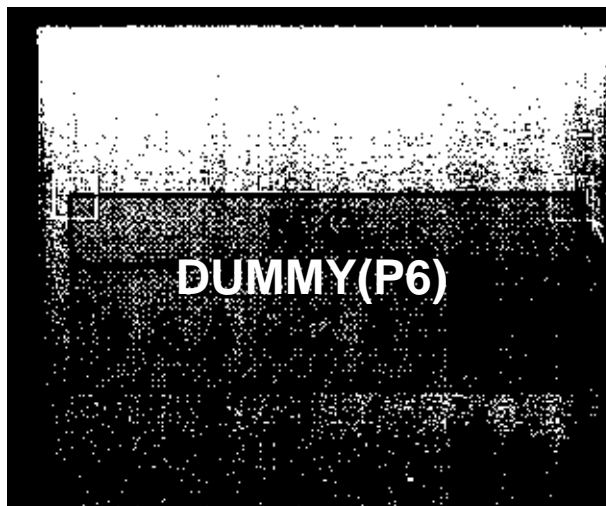

8. Draw the position compensation region. Refer to 4-7-3 *Setting the Position Compensation Region*.

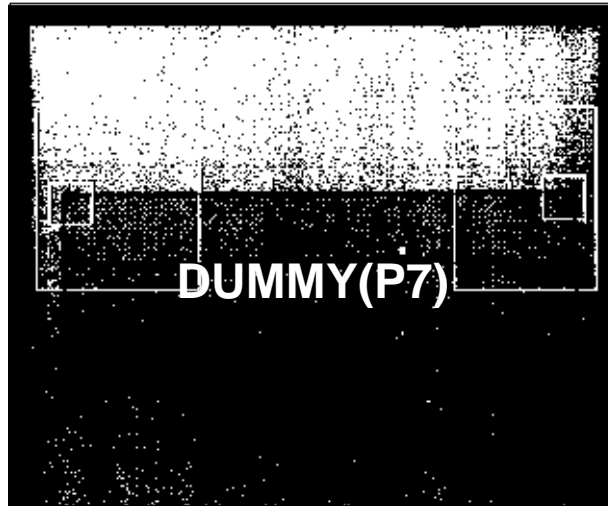

**Setting Calibration Data**

9. Select “1.Rotation positioning” under “U.Process.” “P.Rotation positioning” will be displayed on the menu bar. Refer to 4-3-2 *Switching Processes*.

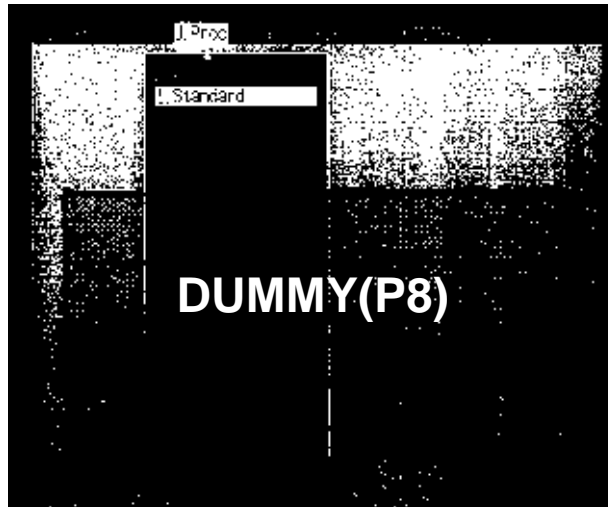

10. Select camera 0. Refer to 4-4-1 *Selecting the Camera Number*.

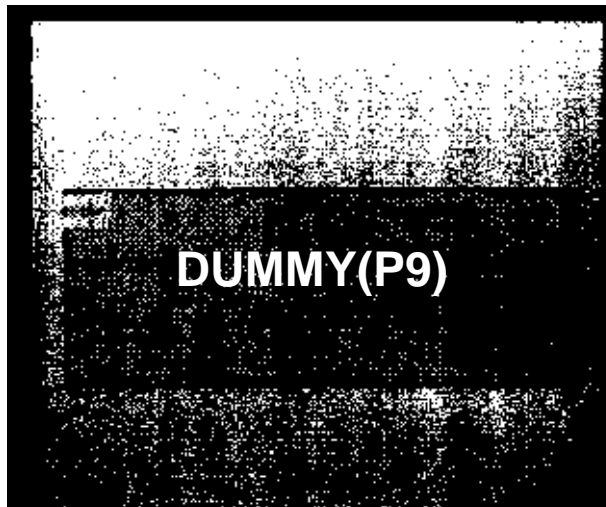

11. Input the camera magnification directly as a numerical value. Refer to 4-4-4 *Setting Calibration Data*.

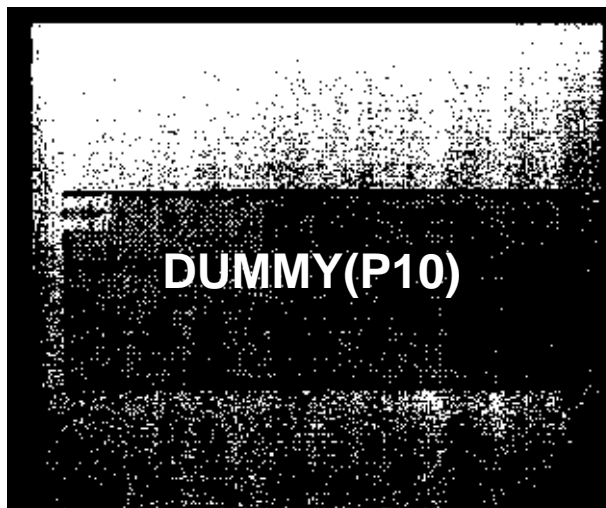

**Setting Rotation Positioning**

12. Set the rotation parameters. Refer to 4-5-1 *Setting the Rotation Parameters*.

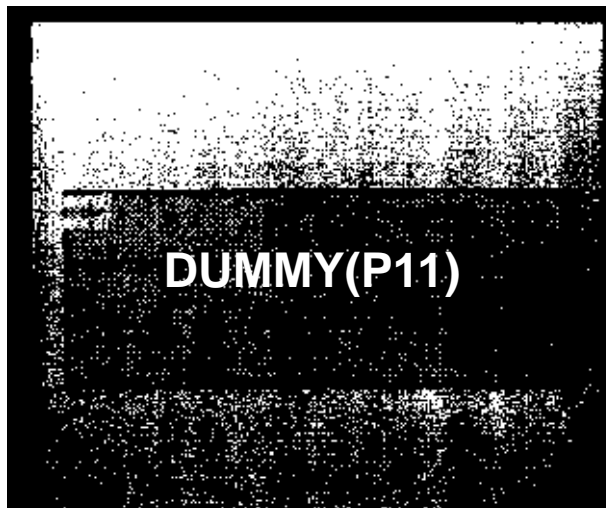

13. Register the measurement model. Register each of the two marks on the CD. Refer to *4-5-2 Registering the Measurement Model*.

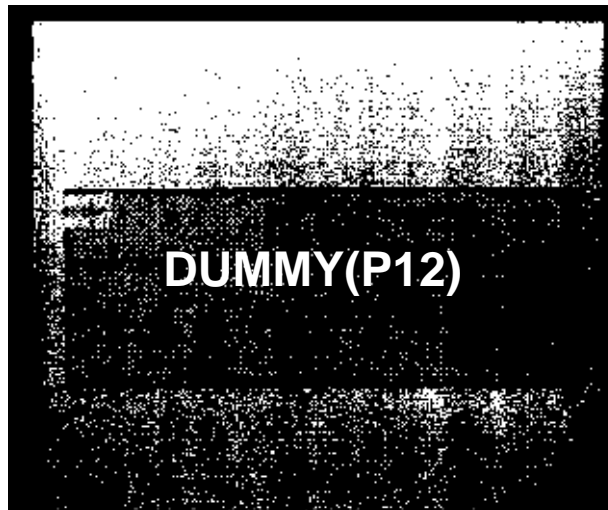

14. Set the search region. Set the search region for each model. Refer to *4-5-2 Registering the Measure Model*.

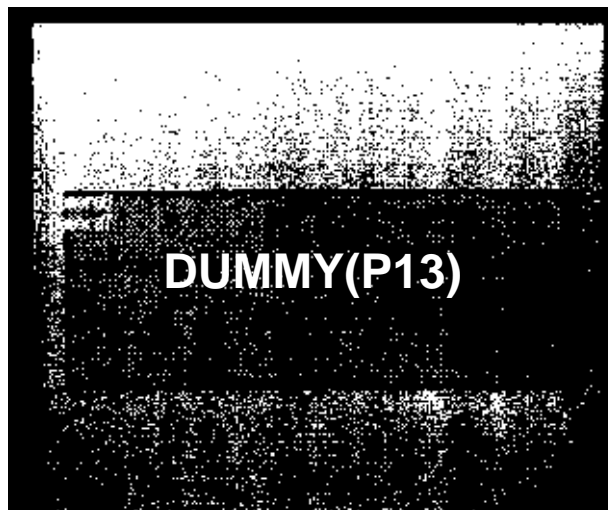

15. Pair the models to be used together. Set the reference model and the relative model. Refer to *4-5-3 Two-model Pairings*.

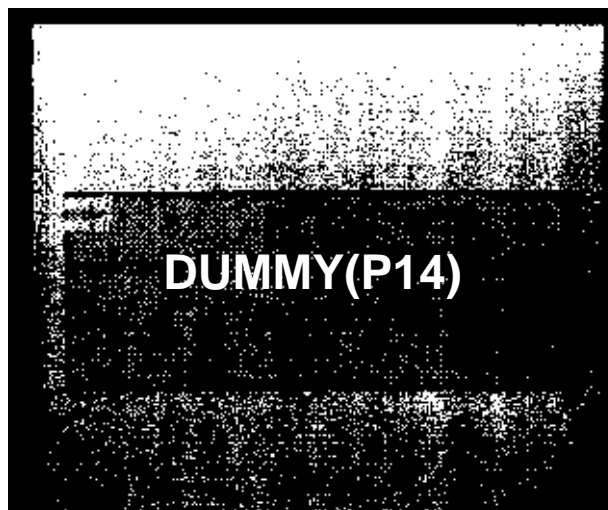

16. Set the distance between two models, in this case, set to "Measurement Value." The distance between the two models is automatically calculated from the coordinates registered for the model and the resulting value is set. Refer to 4-5-3 *Two-model Pairings*.

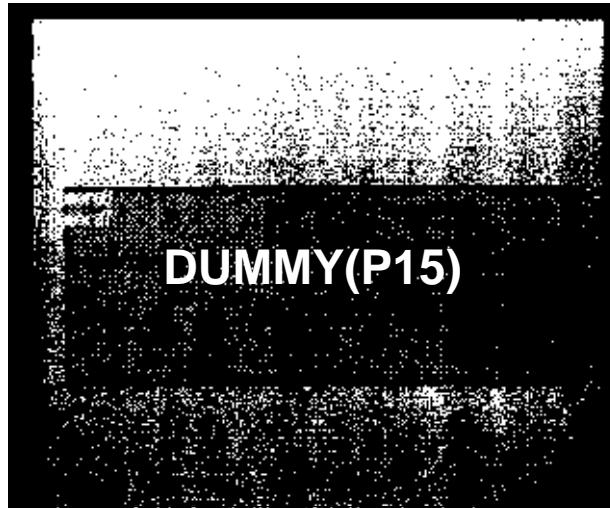

17. Set the output conditions. Set the output device to "Parallel." Refer to 4-5-4 *Setting the Output Conditions*.

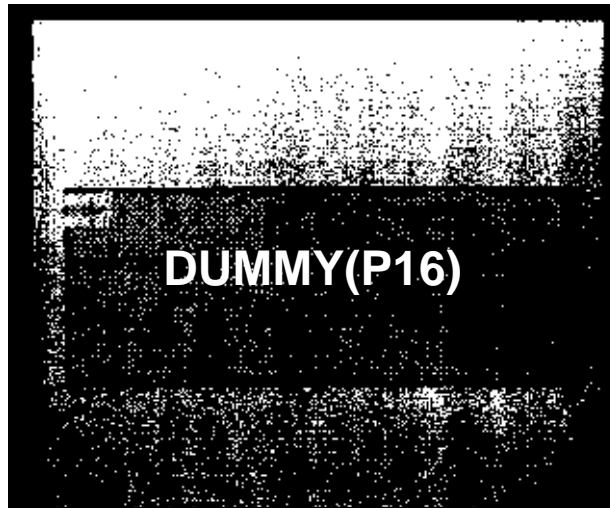



**Measurement**

18. Execute the measurement using the measure command. The measured results will be output to the Video Monitor and Parallel I/O Unit. Refer to *4-9-1 Entering Measurement Screens*.

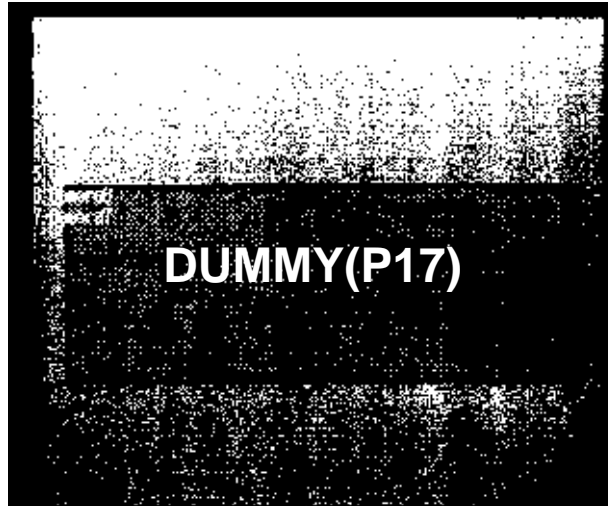

# SECTION 4

## Functions and their Operations

This section provides detailed explanation of the functions and their operations.

### ■ **Setting Conditions**

4-1	S.Scene .....	33
4-1-1	Selecting the Scene Number: S.Scene .....	33
4-1-2	Copying Scene Data: C.Copy .....	34
4-1-3	Clearing Scene Data: L.Clear .....	35
4-1-4	Adding Comments to Scenes: N.Enter Comment .....	35
4-2	D.Display .....	36
4-2-1	Selecting the Image Display Method: F.Freeze .....	36
4-2-2	Inputting Images: I.Input Image .....	37
4-2-3	Inputting Images After Position Compensation: P.Input Image After Position Compensation .....	38
4-3	U.Measurement Item .....	38
4-3-1	Setting Measurement Items: U.Process .....	39
4-3-2	Switching Processes: U.Process .....	41
4-3-3	Copying Measurement Item Settings: C.Copy .....	41
4-3-4	Clearing Measurement Item Settings: U.Process .....	42
4-4	C.Camera .....	43
4-4-1	Selecting the Camera Number: C.Camera .....	43
4-4-2	Selecting Filtering: F.Filtering .....	43
4-4-3	Setting Background Suppression Levels: B.BGS Level .....	47
4-4-4	Setting Calibration Data: A.Calibration .....	49

### ■ **Rotation Positioning**

4-5	P.Rotation Positioning .....	60
4-5-1	Setting the Rotation Parameters: P.Rotation Angle .....	60
4-5-2	Registering the Model: M.Model Registration .....	62
4-5-3	Two-model Pairings: 2.2-model Pairings .....	78
4-5-4	Setting the Output Conditions: O.Output Conditions .....	84
4-6	M.Measure/O.Measure Monitor .....	85
4-6-1	Checking Measurement Values and Measurement Times: O.Measure Monitor ..	85
4-6-2	Setting the Judgement Conditions: O.Measure Monitor .....	88

### ■ **Position Compensation**

4-7	P.Position Compensation .....	90
4-7-1	Selecting the Position Compensation Mode: R.Registration .....	90
4-7-2	Selecting the Rotation Compensation Parameters: T.Rotation Angle .....	115
4-7-3	Setting the Position Compensation Region: A.Region .....	117
4-7-4	Selecting the Position Compensation Speed: P.Speed .....	118
4-7-5	Selecting the Position Compensation Conditions: C.Conditions .....	119
4-7-6	Checking the Set Data: S.Reference .....	120
4-8	M.Measure/O.Measure Monitor .....	121
4-8-1	Checking Measurement Values and Times: O.Measure Monitor .....	121

## ■ Measurements

4-9	M.Measure/M.Measure .....	124
4-9-1	Entering Measurement Screens .....	124
4-9-2	Inputting Instructions from the Console .....	125
4-9-3	Inputting Instructions via RS-232C .....	125
4-9-4	Outputting Measured Results via RS-232C .....	126
4-9-5	Inputting Instructions from Parallel I/O .....	127
4-9-6	Outputting the Measured Results to the Parallel I/O .....	128
4-9-7	Timing Charts .....	129

## ■ System

4-10	Y.System .....	137
4-10-1	Automatic Measurement: M.Initial Mode .....	137
4-10-2	Displaying the Line Brightness: L.Line Brightness .....	138
4-10-3	Saving and Loading Scene Data: S.Scene Data .....	138
4-10-4	Checking Model Registration Conditions: O.Model Information .....	141

## ■ Setting Conditions

### 4-1 S.Scene

The Rotation Positioning Software 1 allows up to 16 measurement conditions called scenes to be set and stored. The data that is stored is called scene data and is identified by scene numbers.

Measurement conditions that have been set can be stored as scene data for each scene number. Refer to *4-10-3 Saving and Loading Scene Data*.

Use memory cards with enough available space for the data that is set. Standard sizes for scene data are provided in *Appendix B*.

**Important** Methods for backing up scene data will differ according to the IMP Unit that is used. When an **F350-C12E IMP Unit** is used, a Memory Card is required in order to use multiple scenes. Scene data other than Scene #0 is backed up on the Memory Card. If no Memory Card is inserted, scenes cannot be switched, copied, or cleared.

- Use separate Memory Cards for backing up, saving, and loading scene data.
- The same memory cards cannot be used with other application programs.
- Do not open the MMI Unit's memory card cover from the time "S.Scene" is selected until you return to the menu bar.

When an **F350-C41E IMP Unit** is used, a memory card is not required in order to switch, copy, and clear scenes.

The "S.Scene" menu allows switching of the scene number and editing scene data.

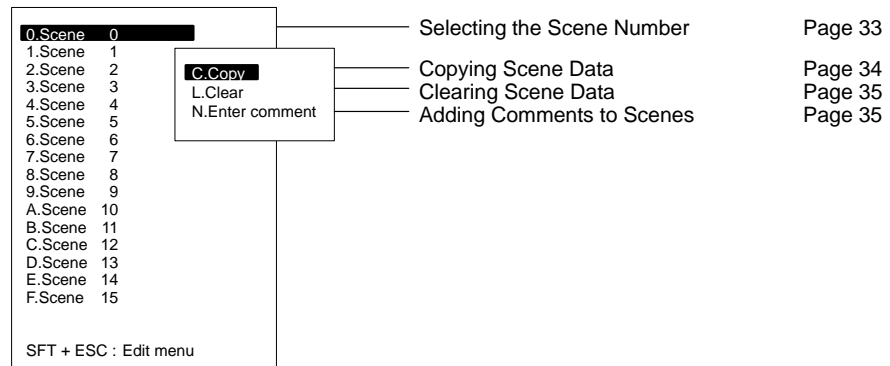

#### 4-1-1 Selecting the Scene Number: S.Scene

"S.Scene" selects the scene number to display. The measurement conditions can be set for the specified scene number and the measurement performed according to the measurement conditions that have been set.

##### Initial Scene Number

The scene number displayed at start up is the same as the scene number displayed when the application program was previously shut down.

The factory default setting is Scene #0 and this scene number is displayed when the unit is first started.

If "A.Automatic execution" is turned on using "Y.System/M.Initial mode," the measurement screen will be displayed for the set scene number.

Refer to *4-10-1 Automatic Measurement*.

##### Displaying Scene Comments

If a comment is input for a scene, the comment is displayed instead of the scene number.

Refer to *4-1-4 Adding Comments to Scenes*.

**Procedure**

Select the scene number. The selected scene will be displayed.

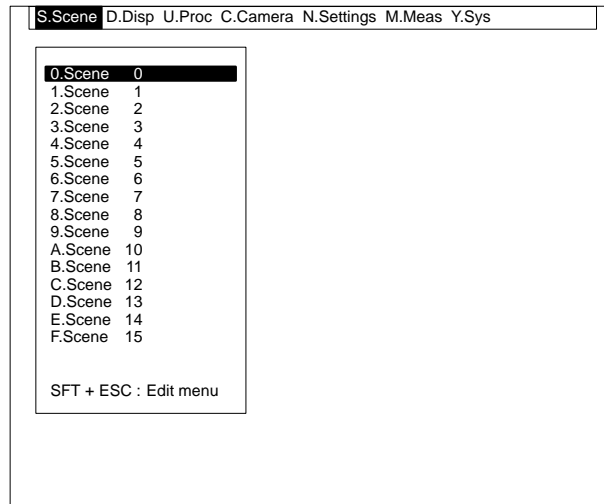
**4-1-2 Copying Scene Data: C.Copy**

“C.Copy” writes the scene data of the selected scene number to a different scene number. “C.Copy” provides a convenient method of re-using existing data when scenes have many conditions in common.

**Procedure**

- 1, 2, 3...**
1. Move the cursor to the copy destination scene number and press the Shift and Escape Keys.
  2. Select “C.Copy.”
  3. Input the copy source scene number.

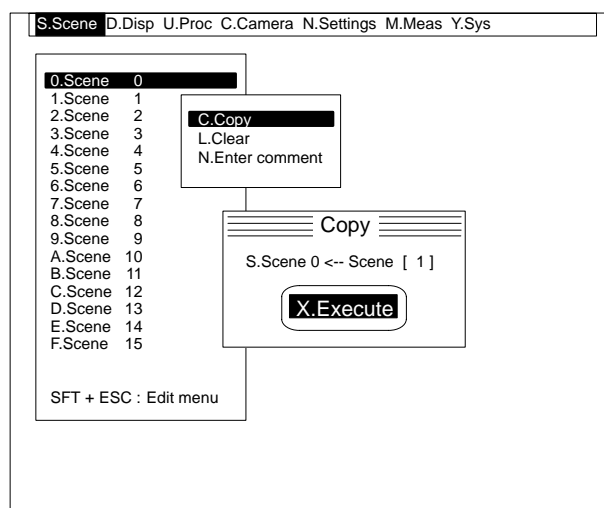

4. Select “X.Execute.” The scene data will be copied from the copy source scene number to the copy destination scene number.

**Important** Copying scene data can take a long time if many measurement models are registered or if the model regions are large. Do not, however, turn off the power during a copy operation as this may destroy the data. If this occurs, clear the set data and restart the system.

### 4-1-3 Clearing Scene Data: L.Clear

“L:Clear” sets the scene data for the selected scene number to the initial default data. Clearing existing data with this instruction is recommended before setting new scene data.

#### Procedure

- 1, 2, 3... 1. Move the cursor to the scene number to be cleared and press the Shift and Escape Keys.
2. Select “L.Clear.” A confirmation message will be displayed.

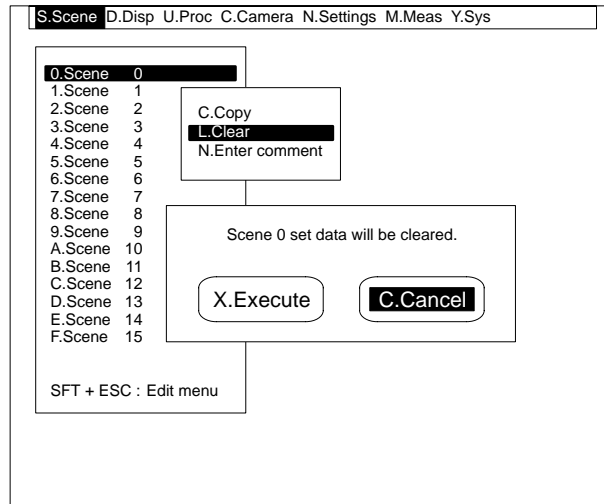

3. Check to see that the selected scene number is highlighted and then select “X.Execute.” All scene data for the selected scene number will revert to the initial default data.

### 4-1-4 Adding Comments to Scenes: N.Enter Comment

“N.Enter comment” can be used to add comments to scenes. Comments, such as the item being measured, can be used as a scene title.

The comment can be up to ten characters long.

#### Procedure

- 1, 2, 3... 1. Move the cursor to the scene number for which a comment is to be entered and press the Shift and Escape Keys.
2. Select “N.Enter comment.”
3. Enter the comment.

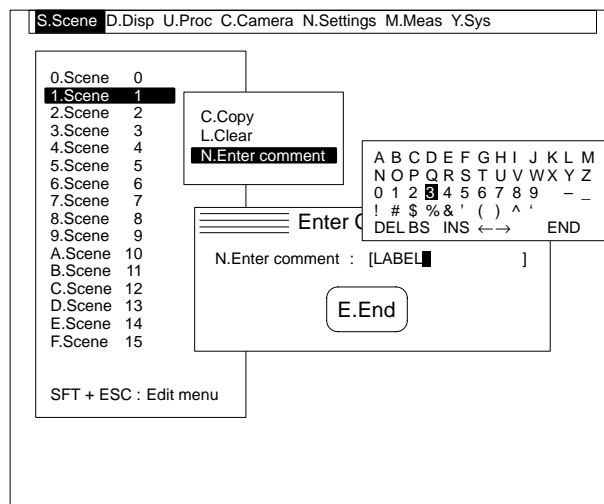

4. Select "E.End." The comment will be displayed instead of the scene number.

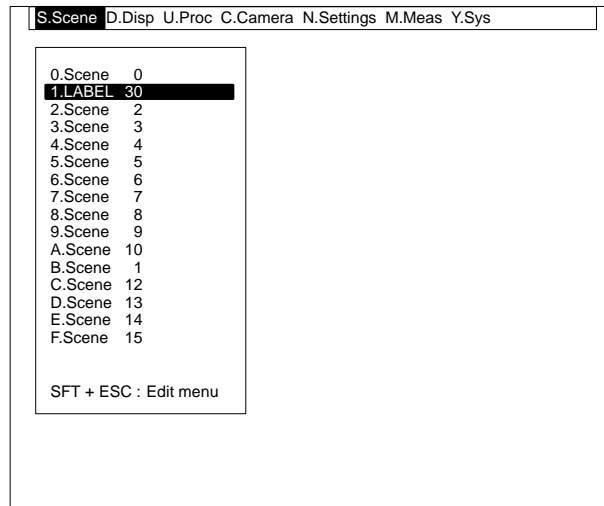

## 4-2 D.Display

"D.Display" can be used to set the method for displaying images on the Video Monitor. Select a display method that is useful for setting scene data and monitoring measurement status.

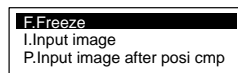

- Selecting the Image Display Method
- Inputting Images
- Inputting Images After Position Compensation

Page 36  
Page 37  
Page 38

### 4-2-1 Selecting the Image Display Method: F.Freeze

There are two methods for displaying images: static (freeze) and dynamic (unfreeze). When unfreeze is selected, images from the camera are displayed as is. Select unfreeze when focusing the camera and adjusting images.

When freeze is selected, images are displayed as static images. Select freeze for displaying as static images the measured images of objects moving at high speed, or for setting data while observing a static image.

There are two methods for displaying static images. One way is to freeze the camera image just as it is, and the other way is to freeze the image after position compensation. For more information, refer to 4-2-2 *Inputting Images* and 4-2-3 *Inputting Images After Position Compensation*.

#### Using Strobes

When unfreeze is selected, strobes flash continuously. When freeze is selected, strobes flash simultaneously with the inputting of images.

#### Timing of Inputting Images

Static (freeze) images are updated when the following functions are executed:

- Start-up
- The scene number is switched using "S.Scene."
- The image is input using "D.Display/I.Input image."
- The image is input using "D.Display/P.Input image after position compensation."
- The camera number is switched using "C.Camera."
- A measurement is executed using "M.Measure/O.Measure monitor."
- A measurement is executed using "M.Measure/O.Measure."

**Procedure**

- 1, 2, 3...**
1. Select "F.Freeze."
  2. Select the display method. If "F.Freeze" is selected, the image at the time "F.Freeze" was selected will be displayed.

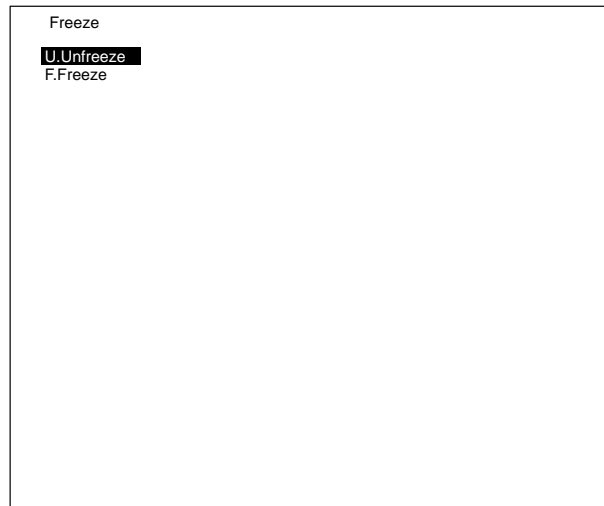

### 4-2-2 Inputting Images: I.Input Image

"I.Input image" displays camera images as static just as they are (i.e., without position compensation). The timing for inputting images can be specified by pressing the Enter Key or using the STEP signal. Images are input simultaneously with the pressing of the Enter Key or inputting of the STEP signal, and the static (freeze) image is displayed. The display method is automatically set to "F.Freeze."

For information on displaying images after position compensation, refer to 4-2-3 *Inputting Images After Position Compensation*.

**Procedure**

- 1, 2, 3...**
1. Select "I.Input image." The dynamic (unfreeze) image will be displayed.
  2. Press the Enter Key or turn ON the STEP signal. The static (freeze) image will be displayed.

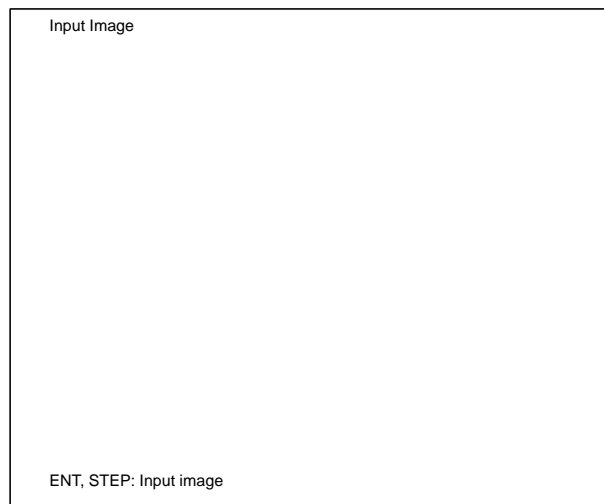



### 4-2-3 Inputting Images After Position Compensation: P.Input Image After Position Compensation

“P.Input image after position compensation” displays as static (freeze) images the image after position compensation in either of the following circumstances:

1. When position compensation is set for the same camera number up to the process number that is currently displayed.
2. When position compensation is set for the process number that is currently displayed.

The timing for inputting images can be specified by pressing the Enter Key or using the STEP signal. Set the position compensation function in advance. For details, refer to 4-7 P.Position Compensation.

Images are input simultaneously with the pressing of the Enter Key or the inputting of a STEP signal, and the static (freeze) images are displayed. The display method is automatically set to “F.Freeze.”

If the measurement object’s position and inclination are not fixed, first display the static (freeze) image after position compensation and then set the measurement conditions.

#### Procedure

- 1, 2, 3... 1. Select “I.Input image.” The dynamic (unfreeze) image and the process number for which position compensation is to be executed will be displayed.
2. Press the Enter Key or turn ON the STEP signal. The static (freeze) image will be displayed.

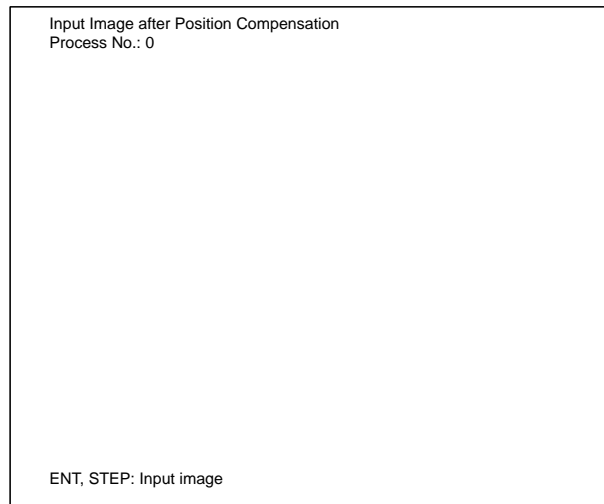

## 4-3 U.Measurement Item

The Application Program contains three measurement items, which are used in combination to perform actual inspections. “U.Process” is used to set up measurement items as processes for execution by performing the following:

- Set the order in which measurement items are to be executed by assigning them to process numbers.
- Switch the measurement item displayed on the menu bar.

You must switch to the process for the desired measurement item before measurement conditions can be set for the measurement item.

For details on the measurement items that can be set, refer to 2-2 Starting and Quitting.

### 4-3-1 Setting Measurement Items: U.Process

“U.Process” is used to set the order in which to execute measurement items by allocating the desired measurement items to process numbers 0 to F. When a measurement instruction is input, the measurement items assigned to process numbers 0 to F are executed in order beginning with the lowest process number.

However, when rotation positioning is executed after position compensation the accuracy of the positioning will be affected. For high accuracy positioning, set rotation positioning only as the measurement item without using position compensation.

Any process number for which no measurement item is set will be skipped.

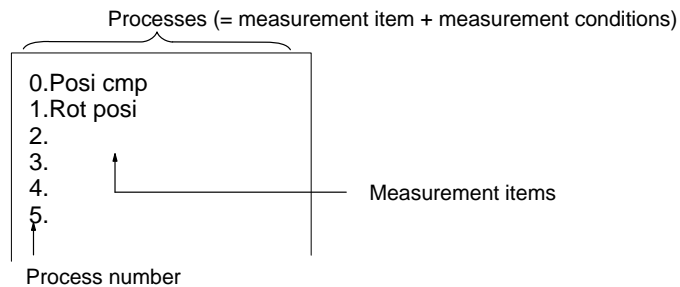

In the above example, Rotation positioning is executed after position compensation.

Up to 16 processes can be set per screen.

**Example:**

Two stages of position compensation can be executed for a single camera. When it is necessary to inspect a large range of rotation, two-stage position compensation can be used to reduce the number of registered rotation models, enabling faster position compensation. Refer to the example in the following illustration.

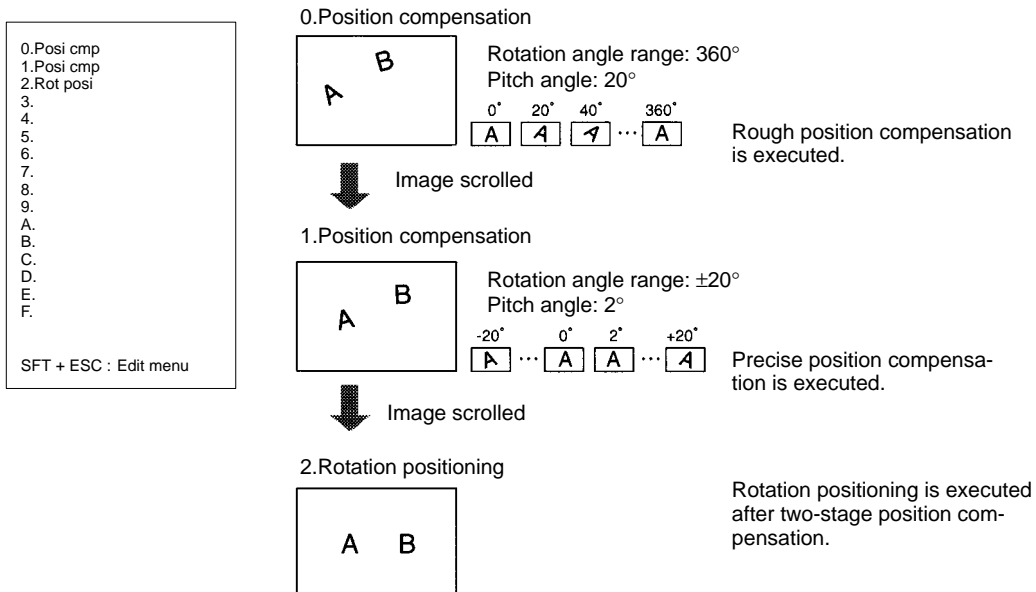

When images of multiple workpieces are input by a single camera, position compensation can be executed for the respective workpieces. Refer to the example in the following illustration.

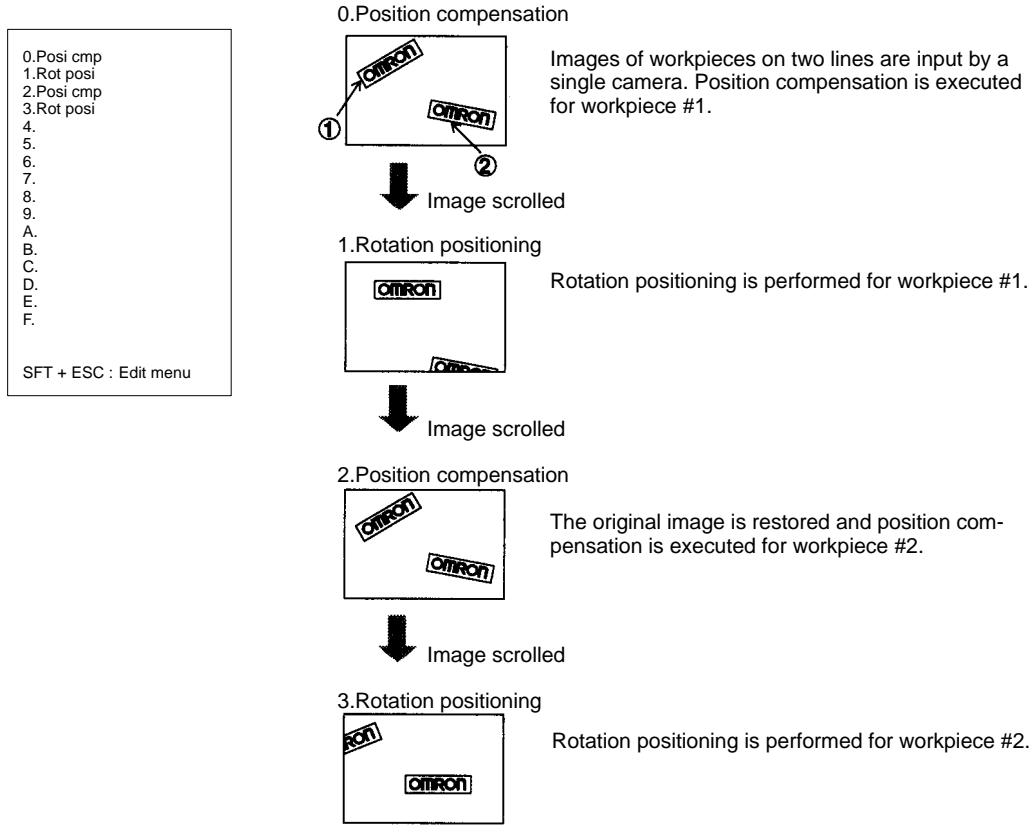

**Procedure**

- 1, 2, 3...
1. Move the cursor to the process number for which the measurement item is to be set, and press the Shift+Escape Keys. The measurement items will be displayed.  
If a process number for which a measurement item is already set is selected, a message will be displayed to confirm that the previously setting should be cleared. To set a different measurement item for that number, execute the "clear" operation.
  2. Select the measurement item to be used for measurement.

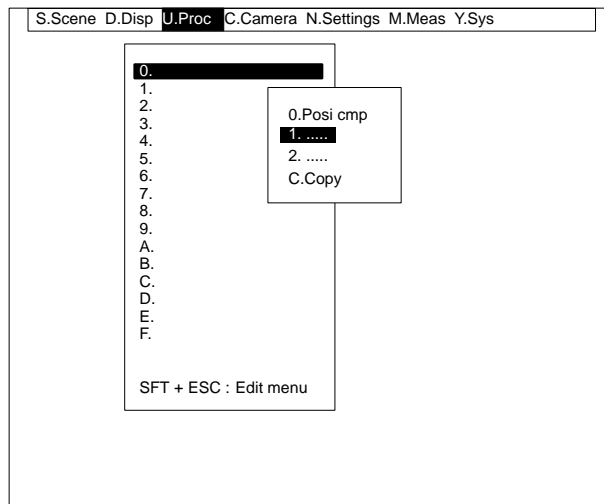

### 4-3-2 Switching Processes: U.Process

“U.Process” is used to select the process to be displayed on the menu bar. The measurement conditions and other settings can then be set for the measurement item that is displayed.

**Procedure**

Select the process number to be switched. The measurement item for the selected process will be displayed on the menu bar.

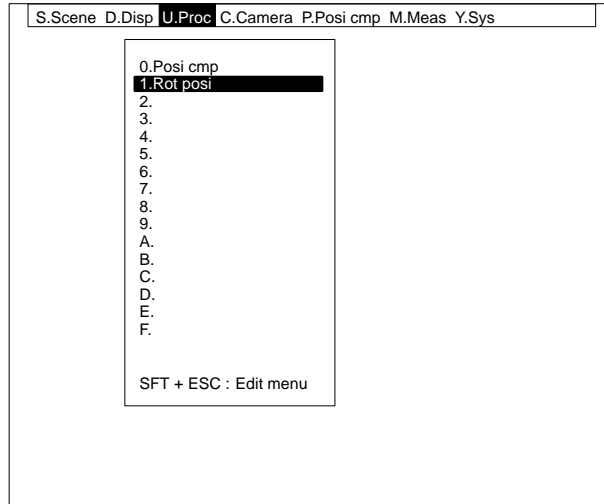

### 4-3-3 Copying Measurement Item Settings: C.Copy

“C.Copy” copies the setting of a specified process number to another process number. In cases where there are a lot of conditions in common between processes, it is convenient to copy process data that has already been created.

**Procedure**

- 1, 2, 3... 1. Move the cursor to the process number of the copy destination and press the Shift+Escape Keys.
2. Select “C.Copy.”
3. Enter the process number of the copy source.
4. Select “X.Execute.” The data will be copied from the copy source to the copy destination.

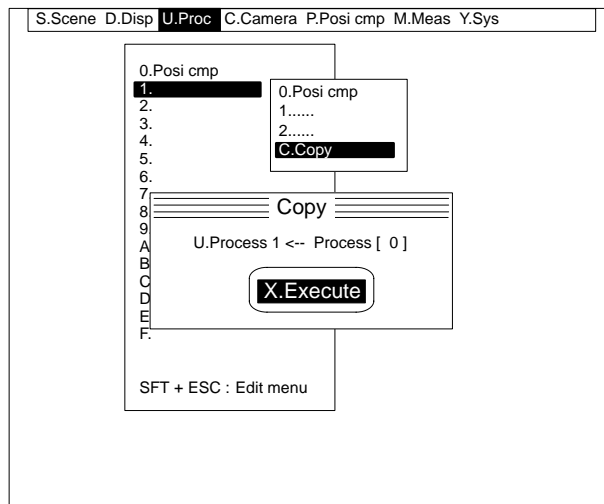

### 4-3-4 Clearing Measurement Item Settings: U.Process

“U.Process” can be used to clear all setting for the specified process number. In order to set a different measurement item for a particular process number, it is first necessary to clear any measurement item that may already be set for that number.

#### Procedure

- 1, 2, 3... 1. Move the cursor to the process number to be cleared, and press the Shift+Escape Keys. A confirmation message will be displayed.
2. Check the process number again, and then select “X.Execute.” All of the data that has been set for that number will be cleared.

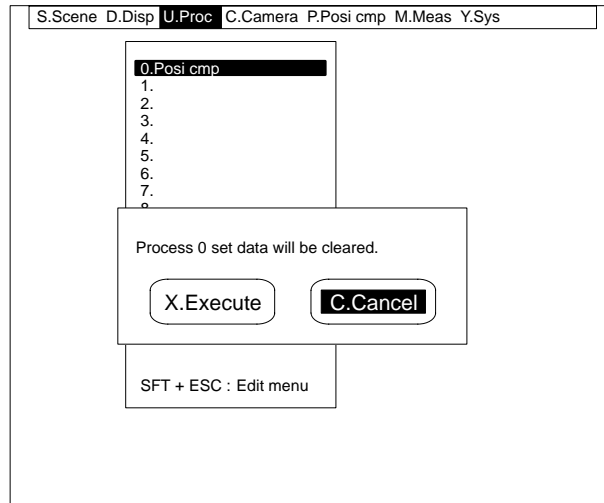

## 4-4 C.Camera

“C.Camera” can be used to select the camera number and set data related to the displayed image of the measured object.

<b>C.Camera</b>	—	Selecting the Camera Number	Page 43
F.Filtering	—	Selecting Filtering	Page 43
B.BGS level	—	Setting Background Suppression Levels	Page 47
A.Calibration	—	Setting Calibration Data	Page 49

### 4-4-1 Selecting the Camera Number: C.Camera

“C.Camera” can be used to select the camera number for the currently displayed process. A camera number can be selected for each process number.

#### Procedure

- 1, 2, 3...**
1. Select “C.Camera.”
  2. Select the camera number. The image from the selected camera number will be displayed.

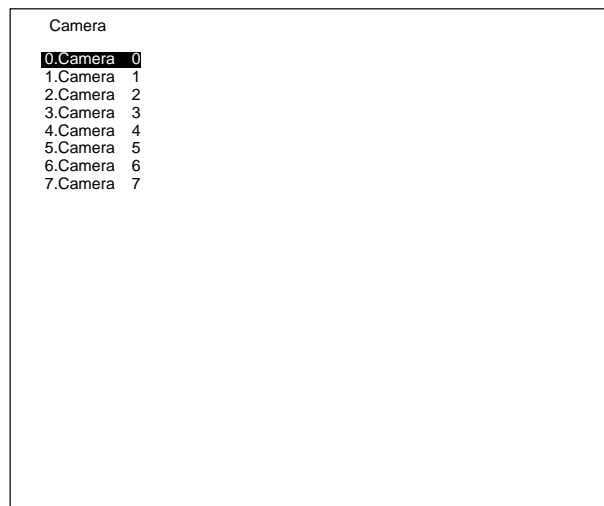

### 4-4-2 Selecting Filtering: F.Filtering

“F.Filtering” is used to process the camera image into an image more suitable for measurement. Select a filtering function that matches the environment and required measurement.

If filtering is specified for a particular camera number, the filtered image is always displayed for that camera number.

If more than one camera is used, filtering can be set individually for each camera.

**Important** Correct measurement is not possible if the filtering and background suppression levels used during measurement are different from those used that were used when the model was registered. When setting the filtering and background suppression levels for the measurement object, set the filter and background suppression levels for each camera number before registering models. Do not change the filtering after registering the models.

**OFF**

No filtering. The raw image is displayed.

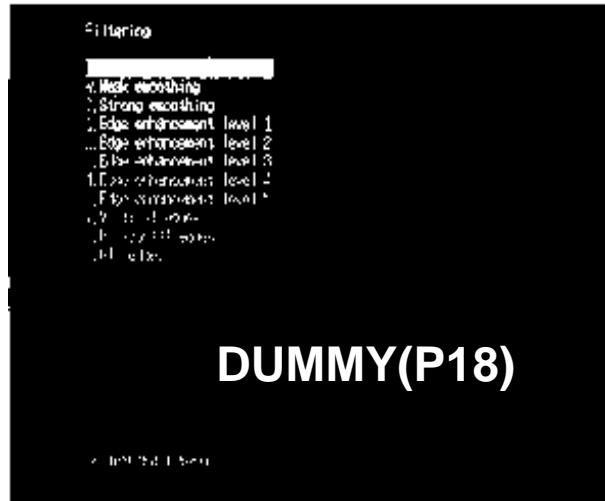

**Smoothing**

Displays a smoothed image with noise suppressed. Smoothing allows suppression of the effects of uneven lighting due to scratches, patterns, or roughness of the surface. Select either weak or strong smoothing.







**All Edges**

Displays an image of all edges between bright and dark regions.

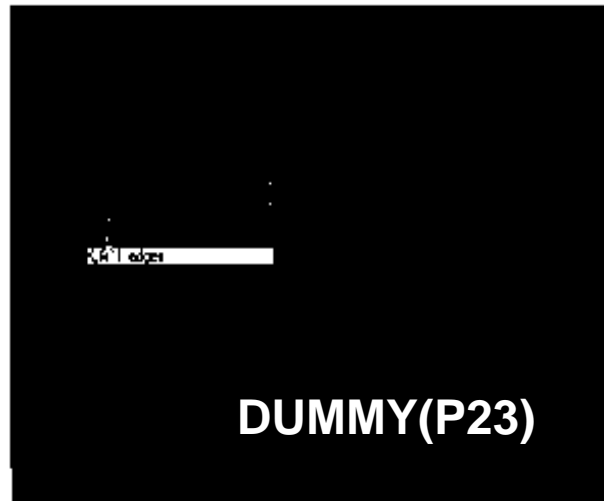
**Procedure**

Select "F.Filtering." The image will be displayed using the filtering at the cursor position. Set the filtering for the displayed camera number.

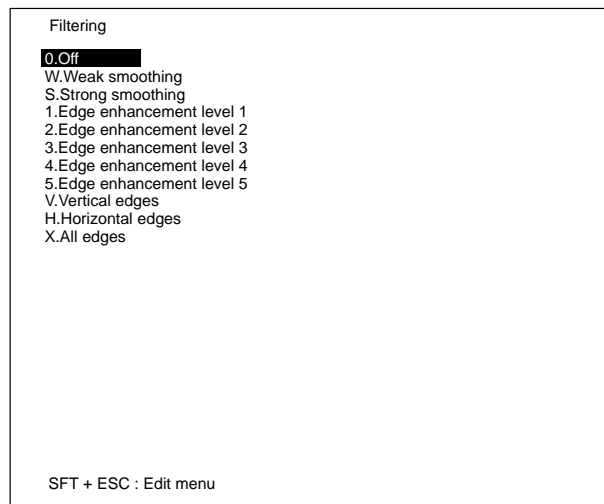
**Copying Filter Settings**

The filter settings for a specified process number can be copied to the process number that is currently displayed.

The measurement time per scene can be shortened if processes with the same camera number, filtering, and background cut level are set consecutively. For details, refer to 4-9-1 *Entering Measurement Screens*.

**Procedure**

- 1, 2, 3... 1. Select "F.Filtering."
2. Press the Shift+Escape Keys. The Edit menu will be displayed.
3. Enter the copy source process number.

4. Select "E.End." The copy source filter settings will be copied.

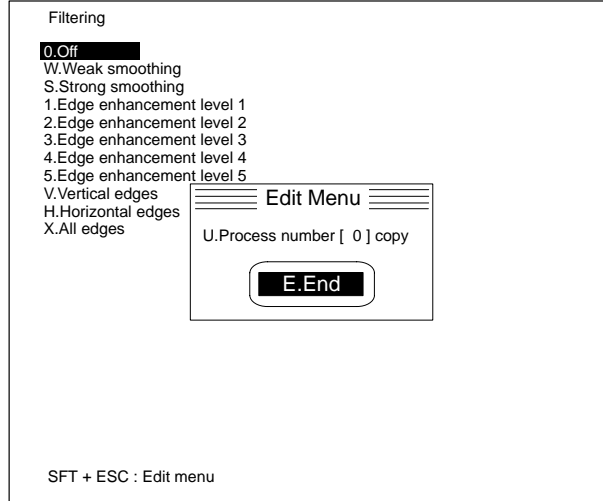

### 4-4-3 Setting Background Suppression Levels: B.BGS Level

"B.BGS level" changes images with densities below the lower limit to 0, and densities above the upper limit to 255. Images with densities between the lower and upper limits are graded from 0 to 255.

Noise can be eliminated by converting the background of the object being read to specific densities.

**Important** Correct measurement is not possible if different background suppression levels are used during measurement than those used when the model data was registered. Do not change the background suppression level after registering the models.

Key input	Action
▲/▼	Select the upper and lower limits.
◀/▶	Change the numbers.

#### Procedure

- 1, 2, 3...
1. Select "B.BGS level."
  2. Set the upper and lower limits.
  3. Press the Enter Key. The upper and lower limits will be set.

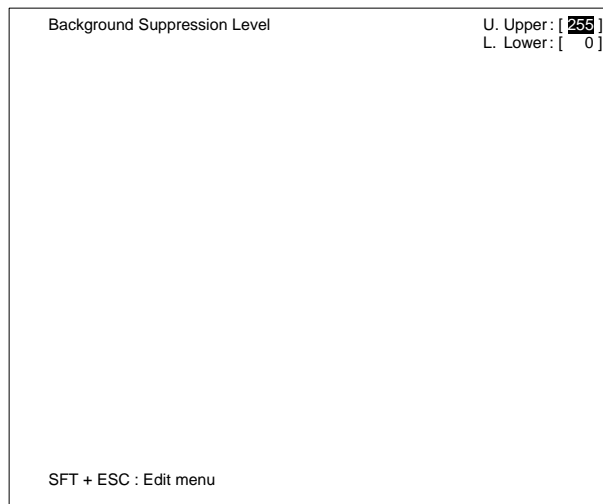

### Copying the Background Suppression Level

The background suppression level for a specified process number can be copied to the process number that is currently displayed.

The measurement time per scene can be shortened if processes with the same camera number, filtering, and background cut level are set consecutively. For details, refer to 4-9-1 *Entering Measurement Screens*.

#### Procedure

- 1, 2, 3...**
1. Select "B.BGS level."
  2. Press the Shift+Escape Keys. The Edit menu will be displayed.
  3. Enter the copy source process number.
  4. Select "E.End." The copy source background suppression level setting will be copied.

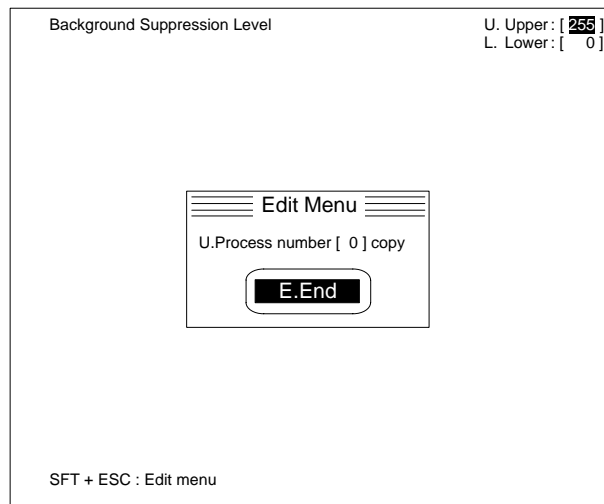

## 4-4-4 Setting Calibration Data: A.Calibration

“A.Calibration” converts inspection results (pixel measurements) into physical units such as mm. Set the calibration data for making this conversion. Refer to the following table for the default values of calibration data.

Parameter	Default value
Field of view	512 (W) x 484 (H)
Magnification	1 (1 mm/pixel)
Coordinate system	Left-handed system
Origin of physical coordinates (0, 0)	Screen coordinates (0, 0)
Camera angle	0°

Different calibration data can be set for each camera according to the field of view. Select a camera number before setting calibration data. Refer to *4-4-1 Selecting the Camera Number*.

### Registering Calibration Models

Set a rectangular region containing a mark (an image with a feature) as the calibration model. The physical coordinates of the mark must be known. The rectangular region is called a “model frame.” Move the mark to two or more positions and input the physical coordinates of the positions to set the calibration data. The position where the physical coordinates are input is called the “reference point.” Calibration models need not be registered if calibration data is set with the “A.Calibration/N.Numeric input” menu.

### Procedure

- 1, 2, 3...**
1. Select “A.Calibration.”
  2. Select “M.Model registration.” A dotted box and an arrow cursor will be displayed.

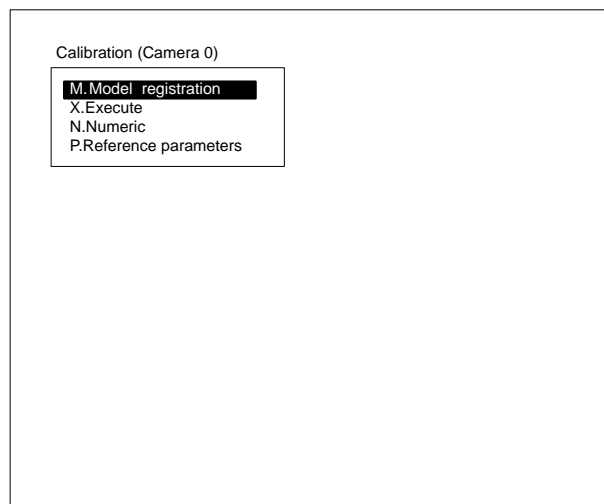

3. Specify the top-left corner coordinates of the model frame.

4. Specify the bottom-right corner coordinates of the model frame.

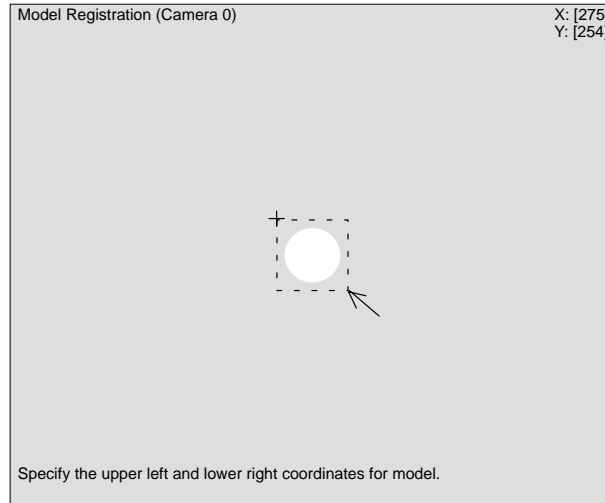

5. Specify the reference point. Press the Enter Key to locate the reference point in the center of the model frame. The image in the model frame will be registered as the calibration model. To change the reference point, go to step 6.

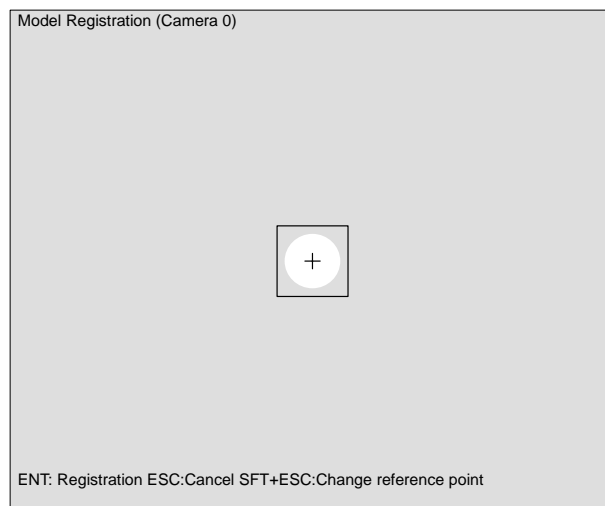

6. Press the Shift+Escape Keys. To specify a point in the model frame as a reference point, perform steps 7 to 9. To specify the center of gravity of the mark as a reference point, go to step 10.

7. Select "H.Manual setting."

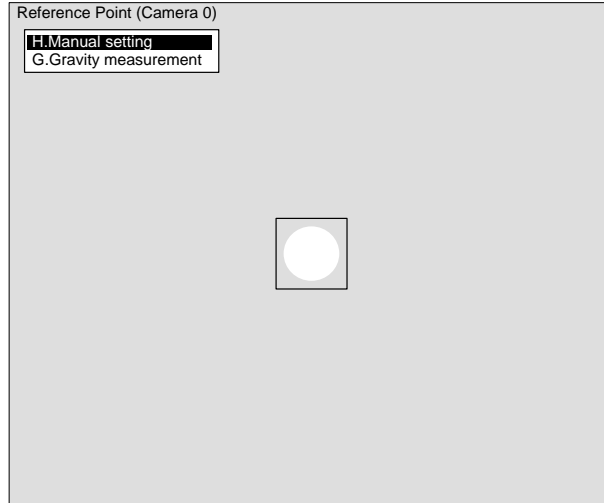

8. Move the cursor to specify the point.

9. Press the Enter Key. The image in the model frame will be registered as the calibration model and the specified point will be used as the reference point.

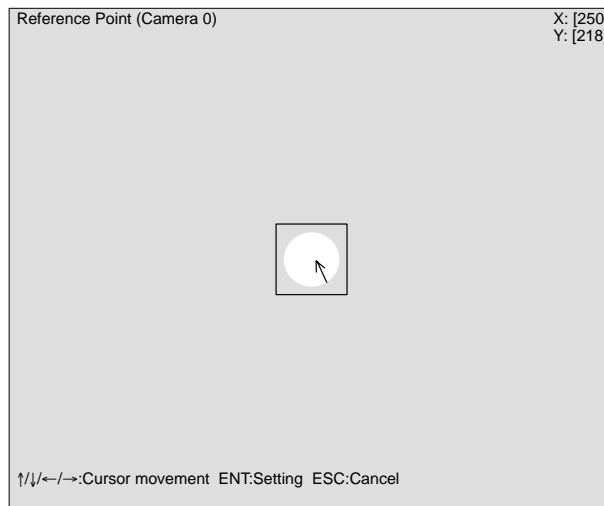

10. Select "G.Gravity measurement."

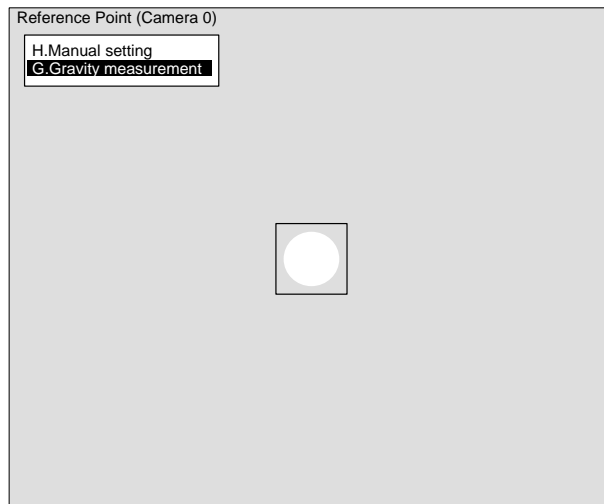

11. Set the binary level to make the mark white.
12. Press the Enter Key. The center of gravity will be measured, and the model frame will be moved so that the center of gravity is in the center of the model frame.

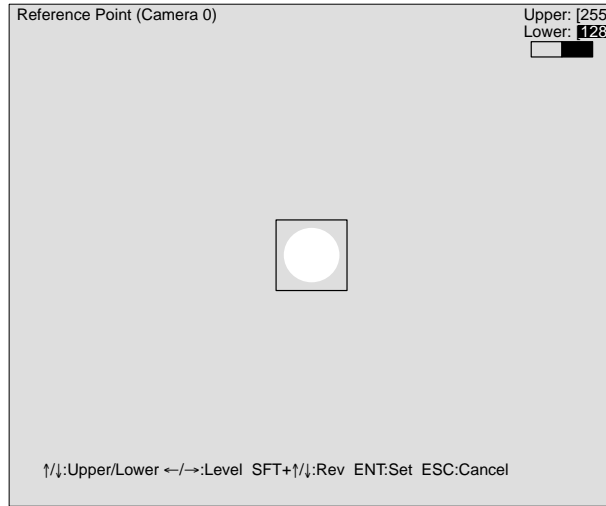

13. Specify the size of the model frame on the basis of the center of gravity.
14. Press the Enter Key. The image in the model frame will be registered as the calibration model and the center of gravity of the mark will be used as the reference point.

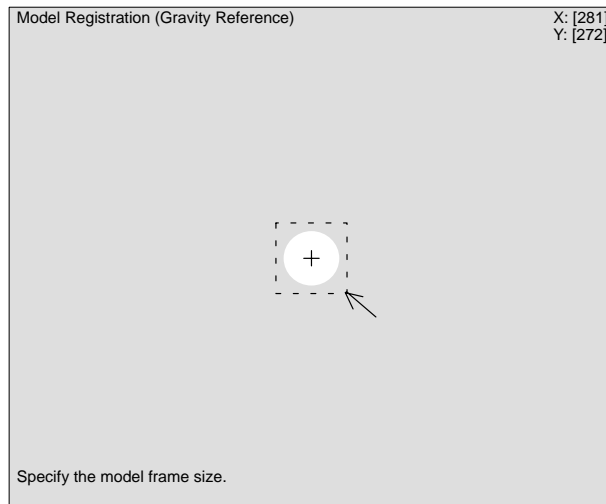

## Setting Calibration Data

The following three methods can be used for setting calibration data. The latest calibration data overwrites the previous calibration data.

### **Sampling**

Search within a search region for an image that has the same pattern as the pattern of the calibration model, and display a cursor in the reference point of the image so that the physical coordinates of the reference point can be input. Move the mark for sampling in two or more positions.

### **Procedure**

- 1, 2, 3... 1. Select "A.Calibration."
2. Select "X.Execute."

3. Select "S.Sampling."

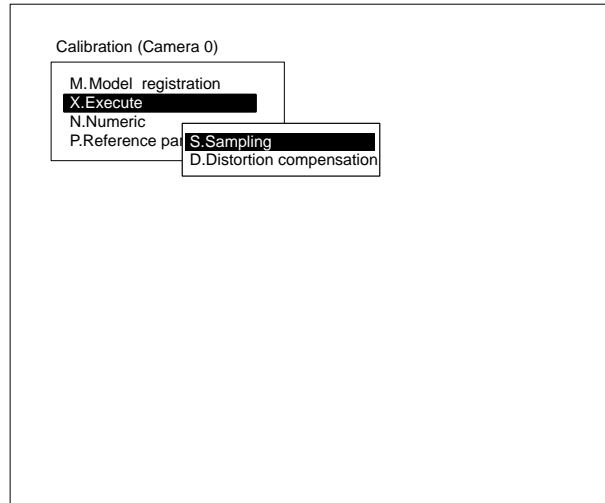

4. Move the workpiece so that the mark will be displayed in the search region. Follow the procedures in steps 5 and 6 to change the search region. If there is nothing to be changed, go to step 7.

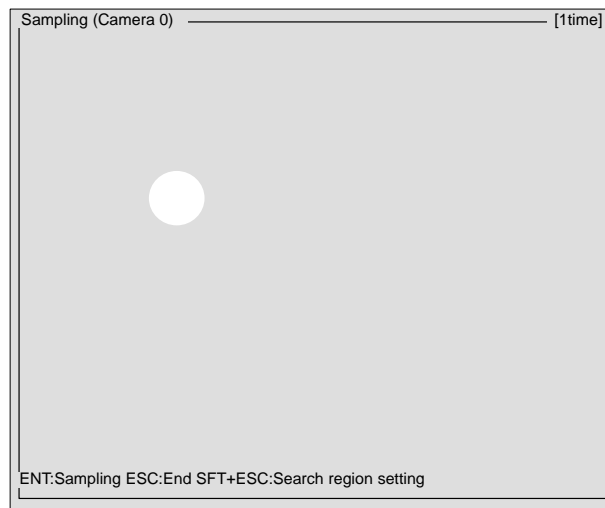

5. Press the Shift+Escape Keys.



6. Specify the coordinates at the top-left and bottom-right corners of the search region.

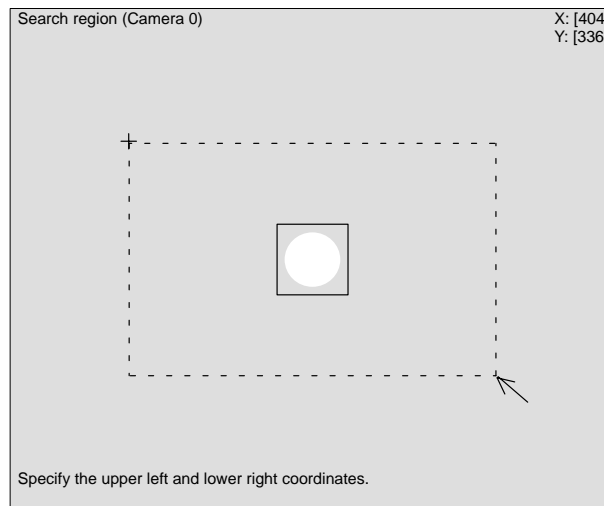

7. Press the Enter Key. Sampling will be executed, a cursor will be displayed in the reference point of the image, and the coordinates menu will be displayed.
8. Set the physical coordinates of the reference point and select "E.End." To execute sampling in two or more positions, repeat steps 4 to 8.

Sampling is possible in a maximum of 15 positions with a calibration model. The larger the number of sampling operations is, the more precise calibration data will be.

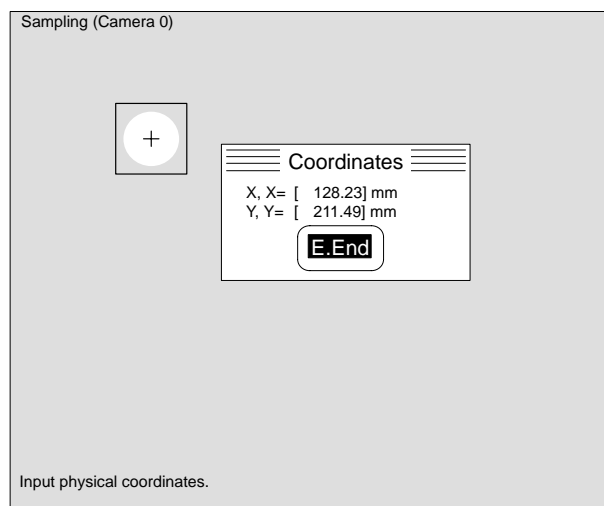

9. Press the Escape Key. A confirmation message is displayed. The confirmation message is displayed automatically when sampling has been executed in 15 positions.

10. Select "X.Execute."

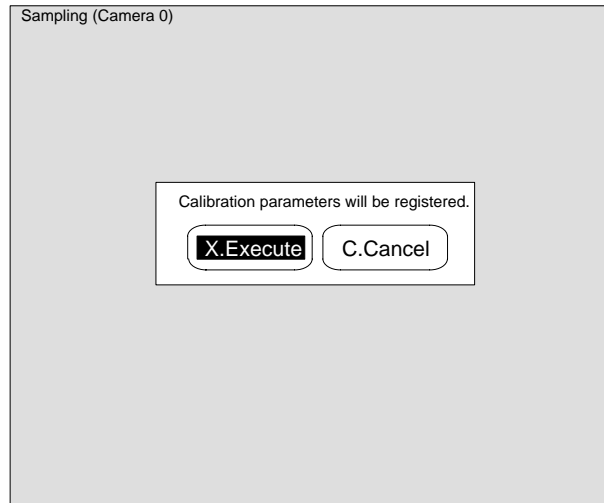

### Distortion Compensation

Optical distortion, which is caused by irregularities in the lens, can be corrected with "D.Distortion compensation". Select "D.Distortion compensation" to obtain more accurate calibration data.

### Procedure

- 1, 2, 3... 1. Select "A.Calibration."
2. Select "X.Execute."
3. Select "D.Distortion compensation." A rectangular region will be displayed at the top-left of the screen.

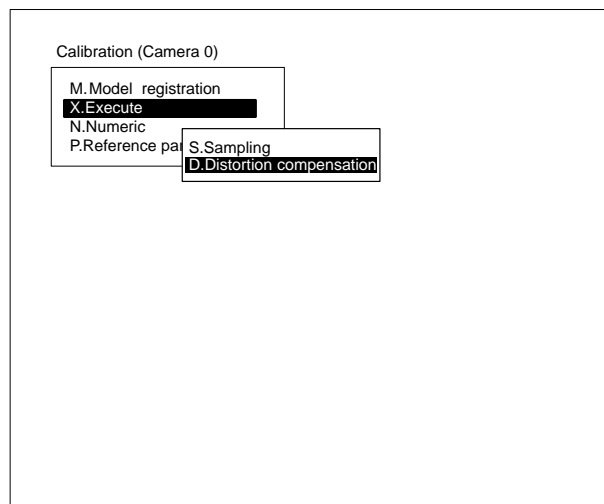

4. Move the workpiece so that the mark is displayed inside this rectangular region.

**Important** Move the workpiece horizontally and vertically only. Incorrect calibration data will result if the workpiece is rotated.

5. Press the Enter Key. A cursor will be displayed in the reference point of the mark, and the coordinates menu will also be displayed.

6. Set the physical coordinates of the reference point and select "E.End." Similar rectangular regions will be displayed at the top-right and bottom-left of the screen. Repeat steps 4 to 6. A message will be displayed when the operation is complete.

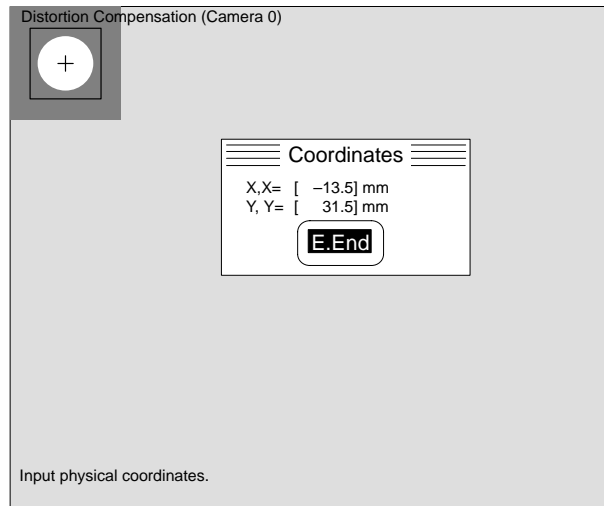

7. Move the mark to the specified physical coordinate position.
8. Press the Enter Key. Repeat steps 7 and 8 as instructed in the messages that will be displayed. A confirmation message will be displayed when the input of all 25 positions is complete.

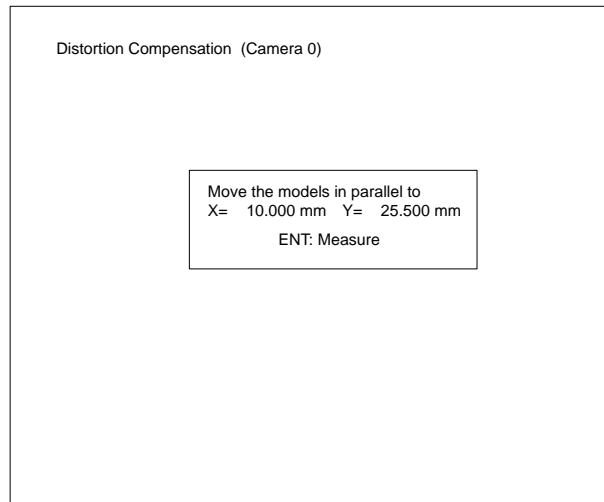

## 9. Select "E.Execute."

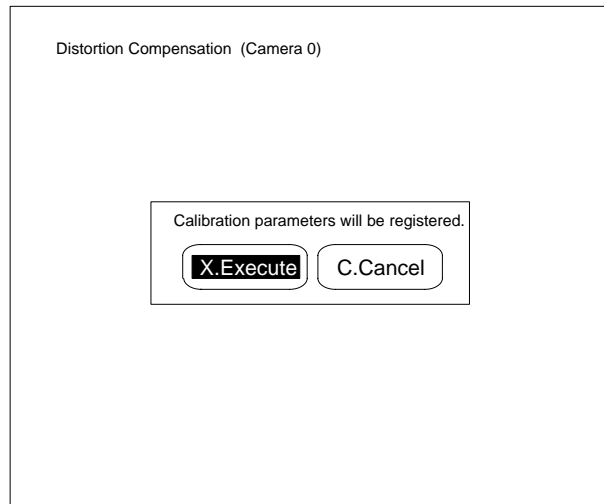
**Numeric**

Input a value directly for the magnification. The magnification indicates the physical dimension per pixel. For example, if a length of 10 mm is displayed with 100 pixels on the screen, the magnification will be 0.1 (10 mm/100 pixels).

Parameters other than the magnification are set to default values. If calibration data has been set with sampling or distortion compensation, all the calibration data will be overwritten.

**Procedure**

- 1, 2, 3...**
1. Select "A.Calibration."
  2. Select "N.Numeric." The Numeric screen will be displayed.
  3. Input the magnification within a range from 0.001 to 9.999.
  4. Select "E.End."

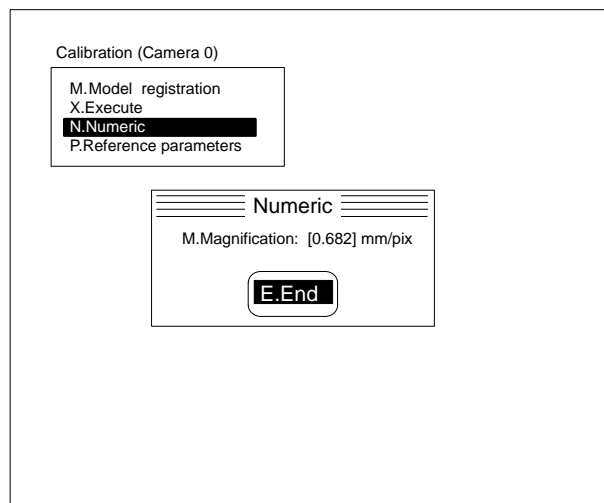

### Checking the Calibration Data

Check the calibration data that has been set.

$\sigma$  is the standard deviation of the errors. This standard deviation is calculated from the errors between the physical coordinates input when the calibration data was set and the coordinates converted using the conversion factors A to F.

The standard deviation is calculated using the following formula.

$$\sigma = \sqrt{\frac{\sum_{i=1}^N \{(RX_i - X'_i)^2 + (RY_i - Y'_i)^2\}}{N}}$$

Where,

Rxi, Ryi: the input physical coordinates (for i = 1 to N)

X'i, Y'i: the physical coordinates converted using the conversion factors (for i = 1 to N)

N: number of data points (no distortion compensation = 5, distortion compensation = 25)

Reference Parameters (Camera 0)	
Parameters for Calibration	
A = 1.0000 mm/pix	D = 0.0000 mm/pix
B = 0.0000 mm/pix	E = 1.0000 mm/pix
C = 0.000 mm	F = 0.0000 mm
$\sigma$ = 0.0000	em = 0.0000 mm
Parameters for Distortion Compensation	
$\alpha_x$ = 0.00000000 /pix <sup>2</sup>	Xc = 255.500 pix
$\alpha_y$ = 0.00000000 /pix <sup>2</sup>	Yc = 241.500 pix
Field of vision : 512.000 mm	

A to F are the calculated conversion factors which are used to convert the camera coordinates to physical coordinates.

The converted coordinates are calculated using the following formula.

$$X' = A * X + B * Y + C$$

$$Y' = D * X + E * Y + F$$

Where,

X, Y: measured position in camera coordinate system (units: pixels)

X', Y': converted position in physical coordinate system (units: mm)

“em” is the maximum error.

The maximum error between the physical coordinates input when the calibration data was set and the coordinates converted using the conversion factors A to F.

The maximum error is calculated using the following formula.

$$em = \text{MAX} \left( \sqrt{(RX_i - X'_i)^2 + (RY_i - Y'_i)^2} \right)$$

Where,

MAX: function to output the maximum value achieved from 0 to N.

Rxi, Ryi: the input physical coordinates (for i = 1 to N)

X'i, Y'i: the physical coordinates converted using the conversion factors (for i = 1 to N)

N: number of data points (no distortion compensation = 5, distortion compensation = 25)

Xc: X coordinate of lens center

Yc: Y coordinate of lens center

$\alpha_x$  is the distortion coefficient in the X direction.  
 $\alpha_y$  is the distortion coefficient in the Y direction.

The physical dimensions in the X direction of the field of view in millimeters (mm).

### Procedure

- 1, 2, 3... 1. Select “A.Calibration.”

2. Select "P.Reference parameters." The parameter table of the calibration data for the currently displayed camera will be displayed.

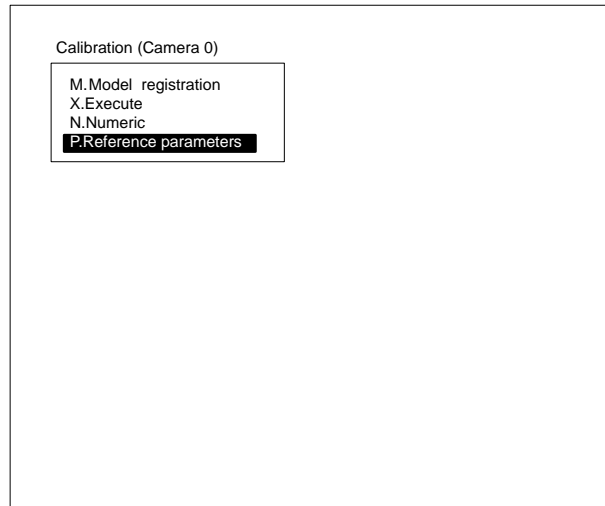

## ■ Rotation Positioning

Rotation positioning appears on the menu as simply “P.Rot posi.”

“P.Rotation positioning” executes positioning of measurement objects according to the position and angle of rotation of marks.

The model is searched for within the search region and the position of the model is measured. The position in which the model was registered becomes the reference position. The degree of displacement from the reference position is output.

Rotation positioning must be set for a process number before it can be used. Refer to 4-3 U.Process.

Select the camera number before setting the measurement conditions. Refer to 4-4-1 Selecting the Camera Number.

### 4-5 P.Rotation positioning

“P.Rotation positioning” registers the measurement model and sets measurement conditions for executing rotation positioning.

P.Rotation angle	Setting the Rotation Parameters	Page 60
M.Model registration	Registering the Measurement Model	Page 62
2.Two-model pairings	Two-model Pairings	Page 78
O.Output condition	Setting the Output Conditions	Page 84

#### 4-5-1 Setting the Rotation Parameters: P.Rotation Angle

“P.Rotation angle” can be used to set the conditions for executing automatic registration of the model and the rotation conditions for measurement. Set the rotation parameters in proportion to the rotation range of the measurement object.

##### Pitch Settings

Item	Details
A.Pitch angle	Registers the models for rotation positioning rotated by this angle within the rotation range.
S.Search verification	<p>Searches for models inside the search region for candidates. Verifies whether or not these candidates are correct.</p> <p>Required: Registers any size model for verification (model A). The rectangular region containing the features will be cut automatically from the region specified as the model. This is the model for searching (model B).</p> <ol style="list-style-type: none"> <li>1) “S.Search verification” searches for model B in the search region and detects candidates. All candidates with correlation values greater than the criteria will be detected.</li> <li>2) For each candidate, verification is executed using the model A, and positions with the highest correlation values are found.</li> </ol> <p>Although high-accuracy rotation positioning can be executed, the processing speed of only the section being verified will become slower.</p> <p>Not required: Registers any size model. Models are searched for in the search region and positions with the highest correlation value will be found.</p>
R.Search criteria	Searches for models inside the search region and sets the criteria for detecting candidates. An object which match the model completely is equal to a setting of 100. Search candidates can be confirmed. Refer to 4-5-2 Registering the Measurement Model.

**Important** If any of the settings related to the rotation parameters are changed after automatic registration of a model, re-register the model.

**Note** Measurement time is longer if the angle range is increased or the pitch of the angle is refined. Refer to 4-6-1 Checking Measurement Values and Measurement Times and 4-9-1 Entering Measurement Screens.

Procedure

- 1, 2, 3... 1. Select "P.Rotation Angle." If there is any change in the pitch angle setting carry out steps 2 and 3. If there is no change go to step 4.

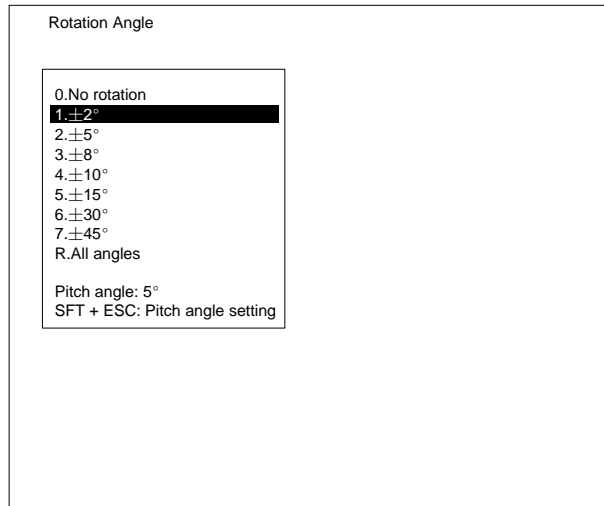

2. Press the Shift+Escape Keys. The pitch settings screen will be displayed.  
3. Set the pitch angle, search verification "Required/Not required," and search criteria.

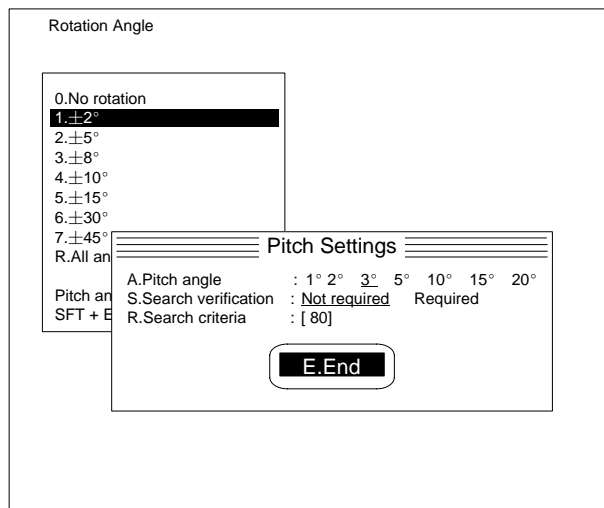



4. Select the rotation parameters. Set the rotation parameters so that they are greater than or equal to the pitch angle.

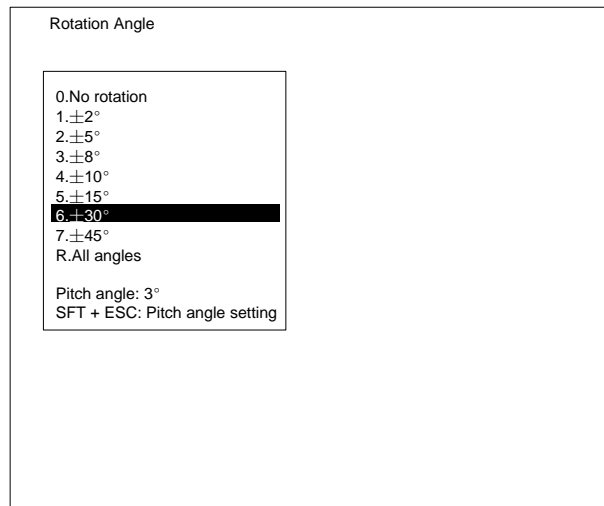

## 4-5-2 Registering the Model: M.Model Registration

In “M.Model registration” the model and the search region are set. Register the image to determine object’s proper position as the model.

**Important** Measurements cannot be executed correctly if the model does not exist inside the search region. If the measurement correlation is less than the search criteria, it is determined that no models exist and an error is output. Refer to 4-9 *M.Measure/M.Measure*.

### Manual Model Registration

This procedure specifies the region to be registered as the model.

**Important** Correct measurement is not possible if different filtering and background suppression levels are used during measurement than those used when model was registered. Ensure that any required filtering and background suppression levels are set before registering the models. Refer to 4-4-2 *Selecting Filtering* and 4-4-3 *Setting Background Suppression Levels*.

Procedure

- 1, 2, 3... 1. Select "M.Model registration."
- 2. Select the model number. A rectangle in dotted lines and an arrow cursor will be displayed.

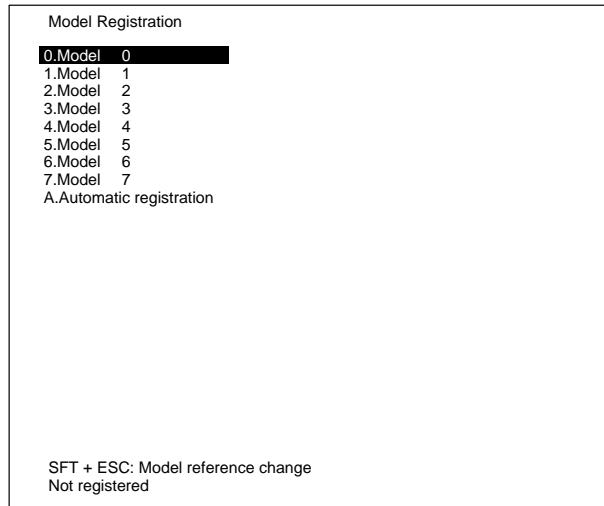

- 3. Specify the upper left and lower right coordinates of the rectangular region to be registered as the model.

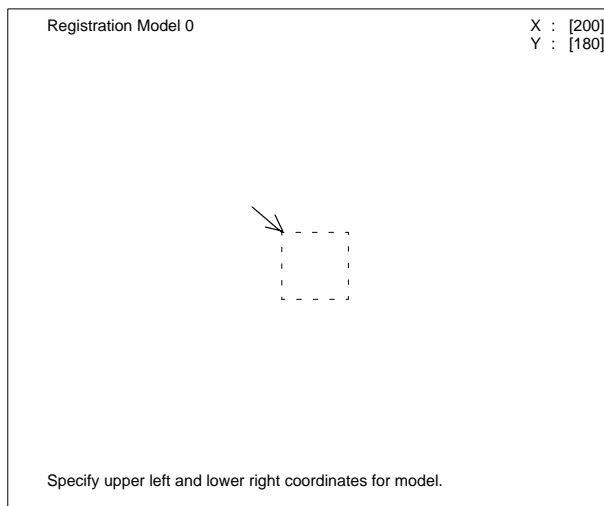

4. Press the Enter Key. The image within the specified rectangular region will be registered as the model. A cursor will be displayed at the reference point. The reference point cannot be changed.

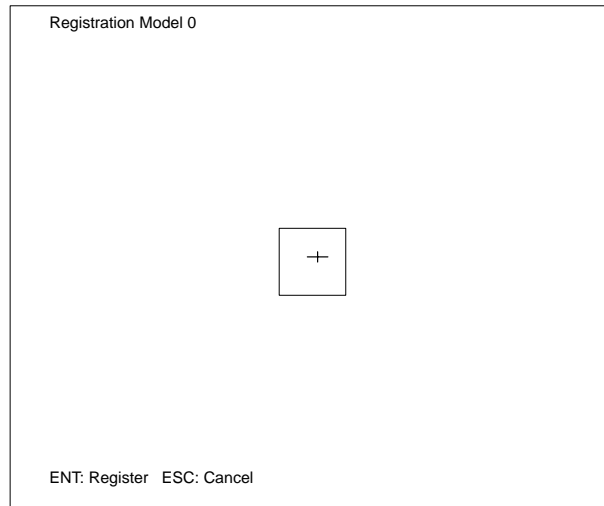

**Important** Do not turn off the power during model registration. If power is turned off during model registration, memory contents will be destroyed and the F350 will malfunction when it is turned on again.

### Modifying the Model

Use this item to modify the model. If the cursor is moved to a model number, the image that has been registered as the model will be inserted into the currently displayed image. If the model image is not required, press the Shift and Escape Keys and set "S.Model reference" to OFF.

#### Procedure

- 1, 2, 3... 1. Select "M.Model registration."
2. Select the number of the model to be modified. The edit menu will be displayed.

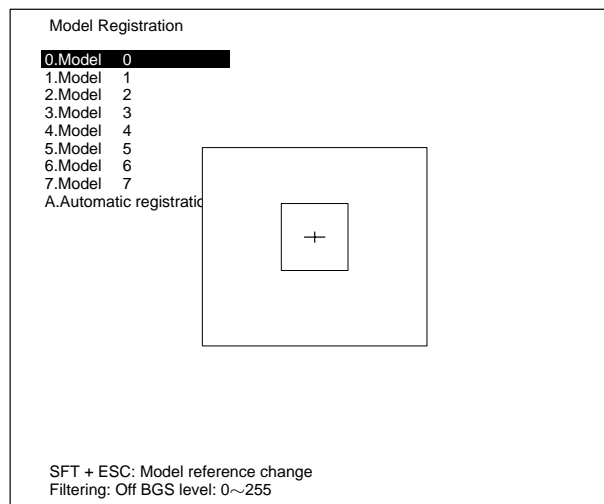

3. Select "R.Modify." A rectangle in dotted lines and an arrow cursor will be displayed.

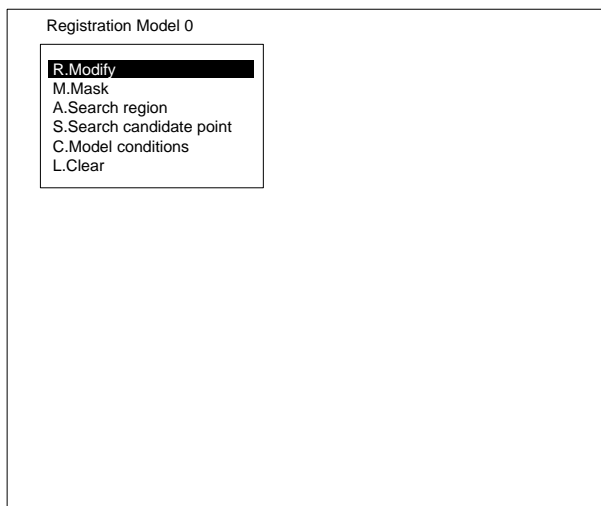

4. Specify the upper left and lower right coordinates of the model's frame.

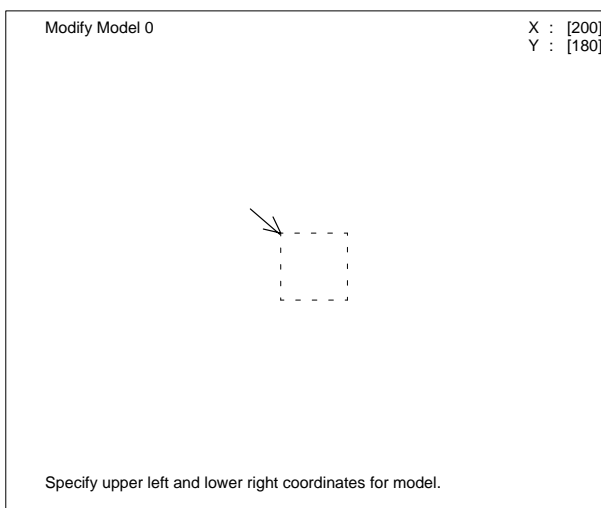

- Press the Enter Key. The image within the specified rectangular region will be registered as the model. A cursor will be displayed at the reference point. The reference point cannot be changed.

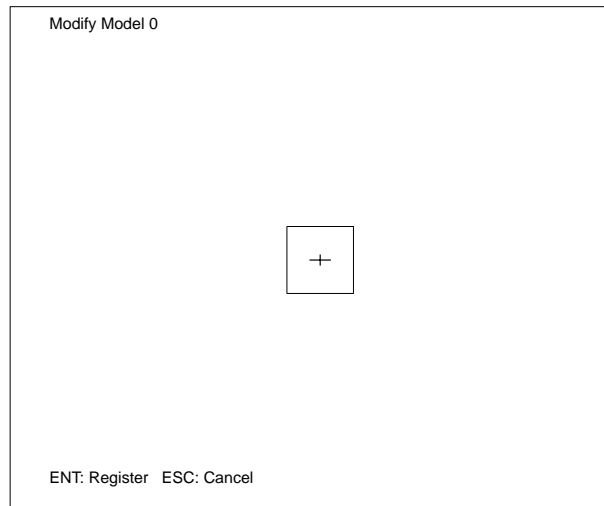

**Important** Do not turn off the power during model registration. If power is turned off during model registration, memory contents will be destroyed and the F350 will malfunction when it is turned on again.

### Setting Mask Regions

Use this item to mask part of rectangular regions that have been registered as models. This item makes it possible to eliminate part of each model or register the eliminated part as a new model. It is not, however, possible to change the size of the rectangular region. Use a combination of the following figures to draw a mask.

Figure	Drawing method
B.Box	Specify 2 diagonally opposing corner points.
C.Circle	After specifying the center of the circle, specify any point on the circumference.
P.Polygon	Specify the adjacent corners in sequence. A maximum of 64 corners can be specified. Designate the last corner (to be connected to the first corner) and then press the Enter Key twice to create the polygon.

To draw the figures, select a drawing mode. There are two drawing modes. They are as follows:

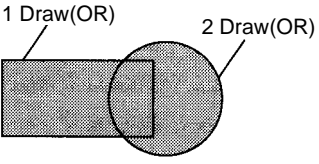
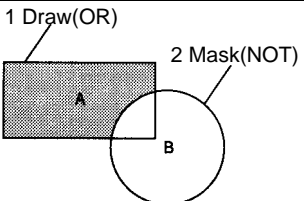
Drawing mode	Action
O.Draw(OR)	 <p>Used to draw regions to register as models. These regions are drawn in rectangular regions that had previously been registered as models.</p>
M.Mask(NOT)	 <p>Used to mask and delete parts of models. The regions that are drawn are removed from the models.</p>

Procedure

- 1, 2, 3... 1. Select "M.Model registration."
- 2. Select the number of the model in which a mask is to be set. The edit menu will be displayed.

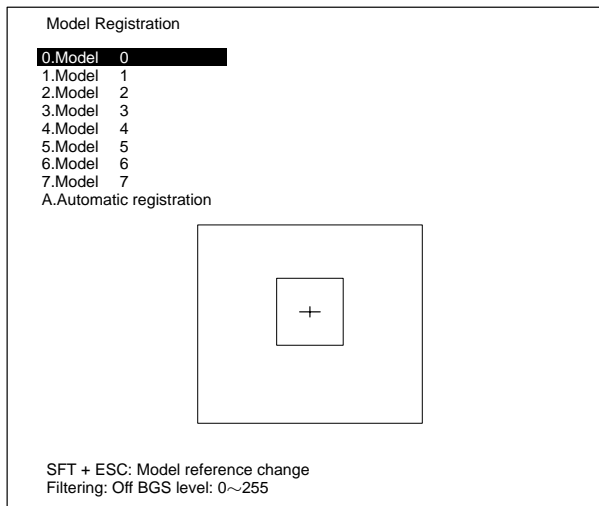

- 3. Select "M.Mask."

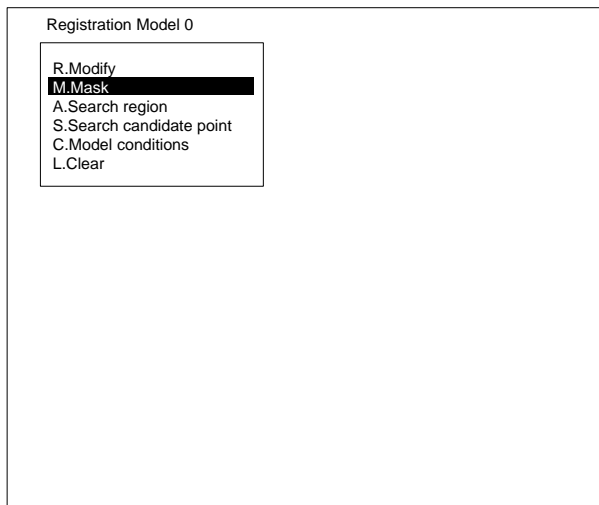

- 4. Select the figure to be drawn.

5. Select a drawing mode.

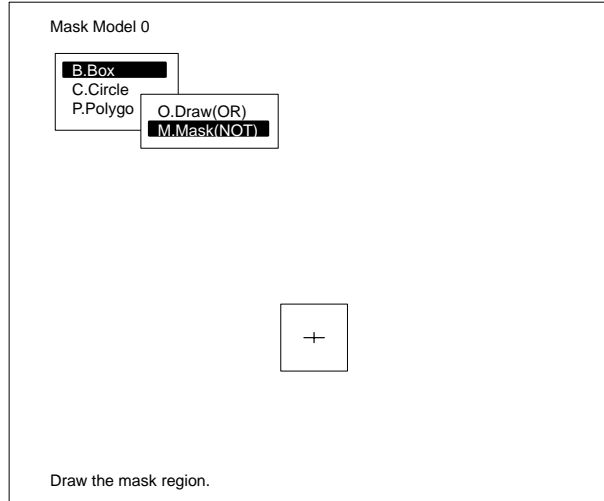

6. Specify the region to be masked. Move the arrow cursor to specify the coordinates according to the drawing mode.

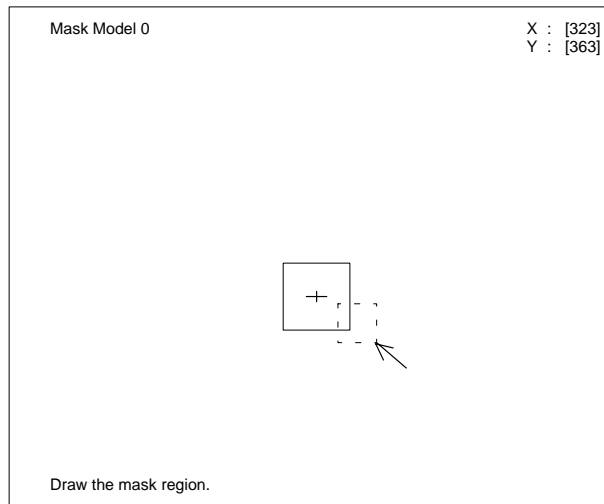

**Important** Do not turn off the power while setting mask regions. If power is turned off while setting mask regions, memory contents will be destroyed and the F350 will malfunction when it is turned on again.

### Setting Search Regions: S.Search Region

Use this item to set a search region for each model individually. The search region should be large enough to search for models even if they are not consistently positioned.

#### Procedure

- 1, 2, 3... 1. Select "M.Model registration."
- 2. Select the number of the model in which the search region is to be set. The edit menu will be displayed.

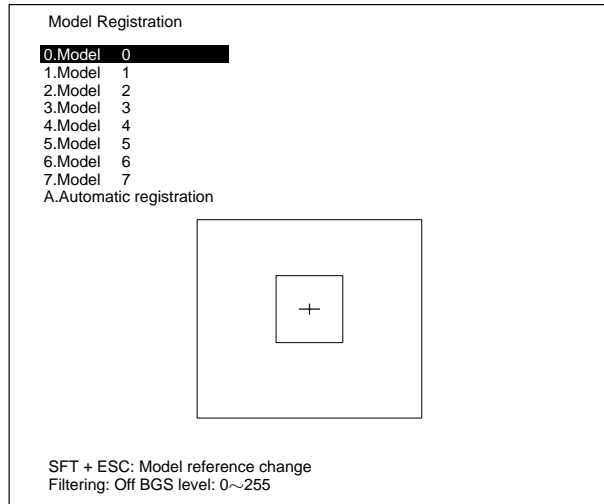

- 3. Select "A.Search region." A dotted line frame and arrow cursor will be displayed.

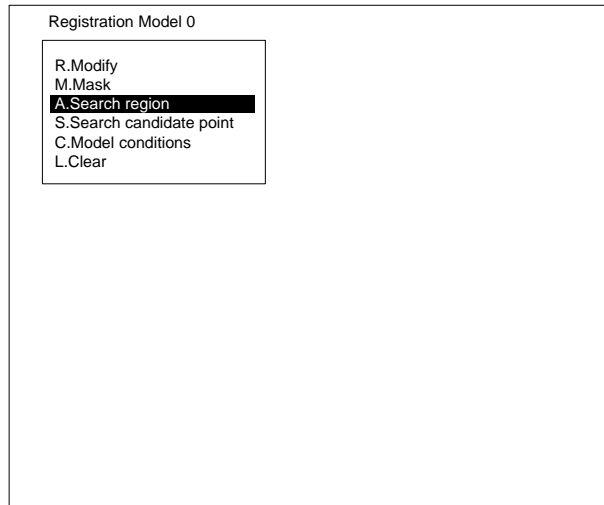



- Specify the upper left and lower right coordinates of the search region. The specified search region will be registered.

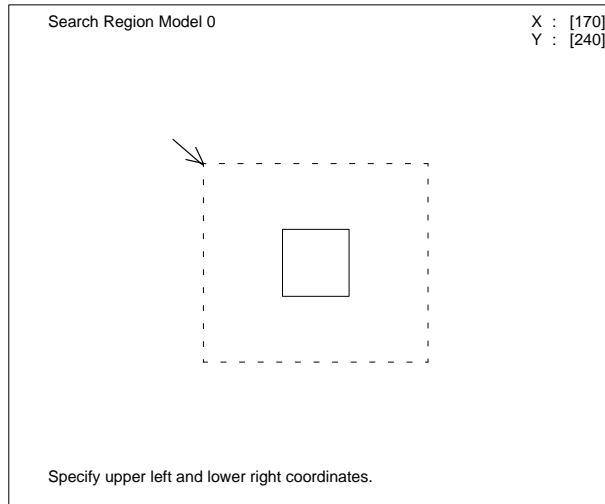

### Checking the Search Candidate Points

When “P.Rotation angle/S.Search verification” is set to “Required,” a search for models within the search region will be executed and candidate points will be detected. An actual search is performed so the number of search candidate points detected can be confirmed. Search criteria, however, cannot be changed on this screen.

To change the search criteria: Refer to 4-5-1 *Setting the Rotation Parameters*.

### Procedure

- 1, 2, 3... 1. Select “M.Model registration.”
2. Select the number of the model in which the search region is to be set. The edit menu will be displayed.

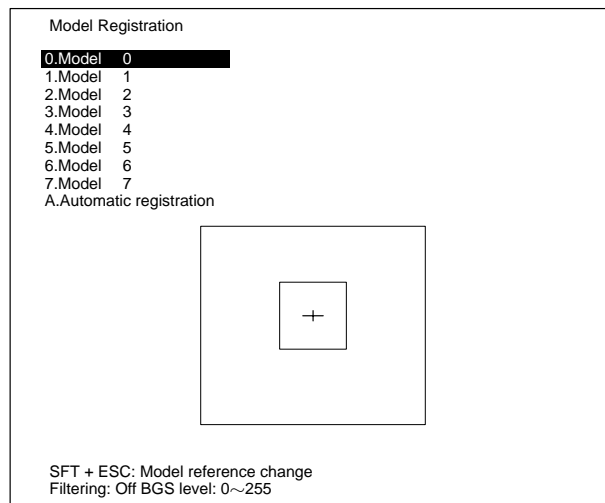

3. Select "S.Search candidate point." The models within the search region will be searched consecutively.

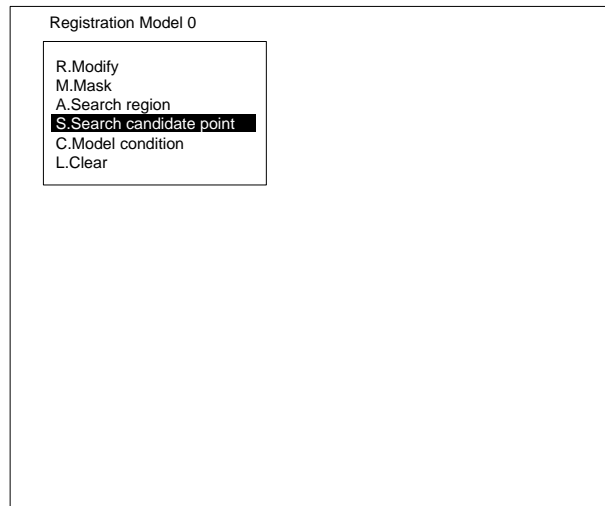

4. Confirm the candidate points.

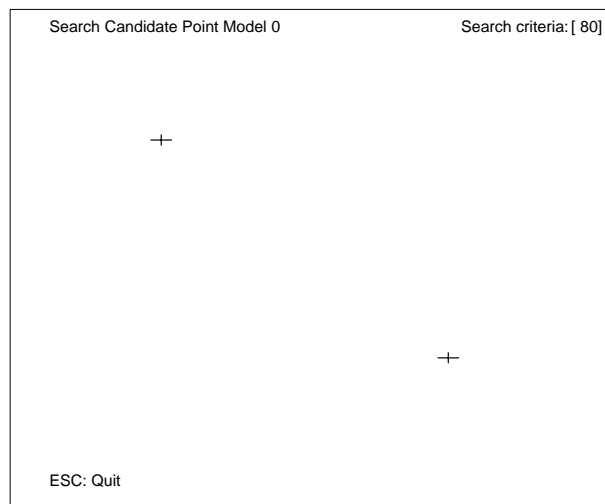

### Setting the Model Conditions

Rotation positioning detects the highest correlation value to the model, and outputs the amount of displacement from the reference position. If the correlation value is small, other positions may be found before the mark for positioning. The correlation criteria are set so that the mark for positioning can be distinguished in the data output to the measurement monitor screen. When the correlation value equals or exceeds the criteria it is judged OK, and NG when it is less than.

Select the level of precision for finding the model's position during the search. The position of the model is usually found in the unit below pixels or subpixels. To reduce the time required for measurement, set the precision to normal to output the measured results in pixels.

Measurement precision	Unit
Normal	Pixels
High	Subpixels

Procedure

- 1, 2, 3... 1. Select "M.Model registration."  
2. Select the model number for setting the conditions. The edit menu will be displayed.

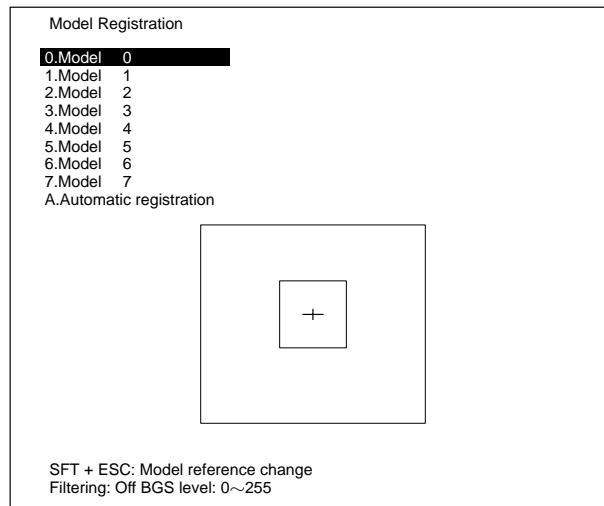

3. Select "C.Model conditions."

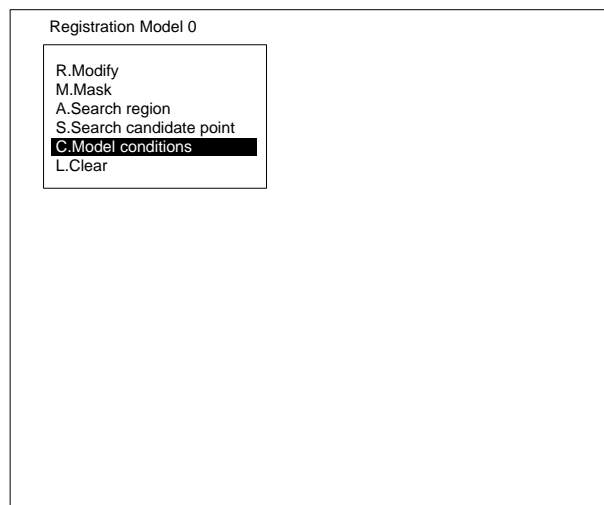

4. Set the correlation values and the measurement precision.

5. Select "E.End."

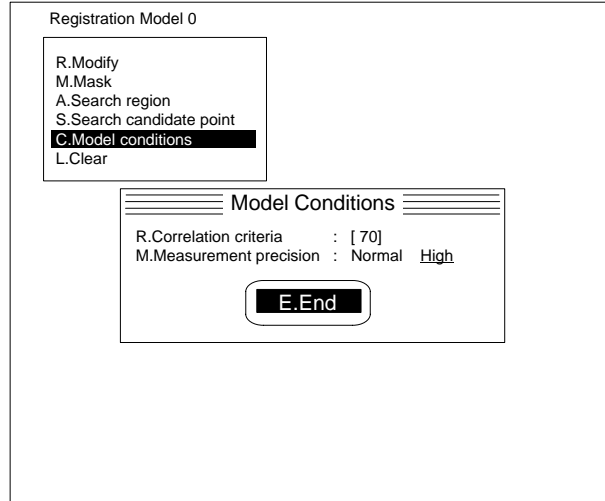

**Clearing the Model**

This item is used to to clear all search regions and models and to reset them to the default value. Clear all models which are not being used for measurement.

**Procedure**

- 1, 2, 3...
1. Select "M.Model registration."
  2. Select the number of the model to be cleared. The edit menu will be displayed.

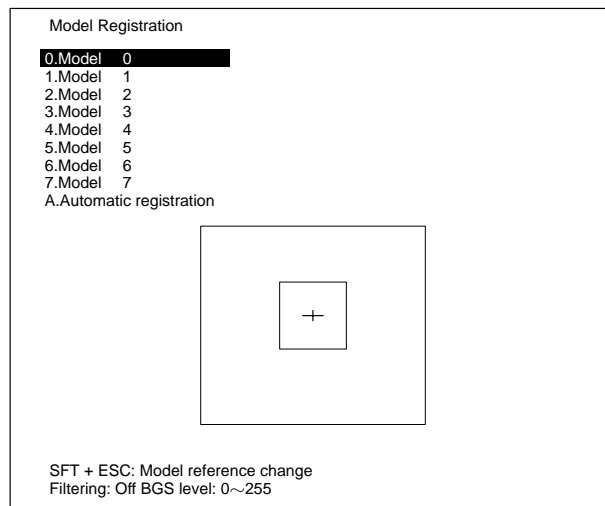

3. Select "L.Clear." A confirmation message will be displayed.
4. Select "X.Execute." The specified model will be cleared.

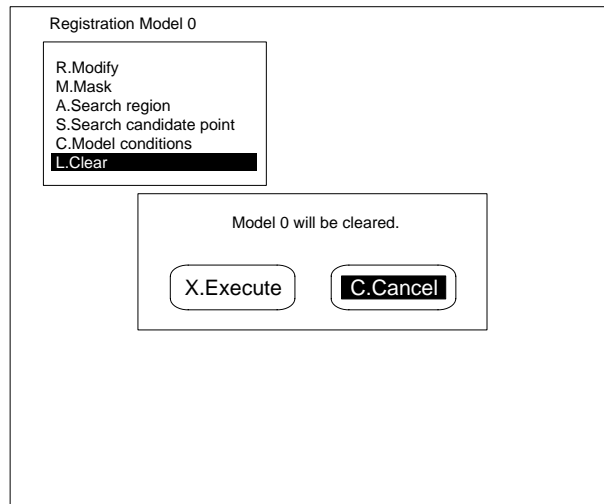

**Automatic Model Registration**

This item cuts the most appropriate region for rotation positioning automatically and registers it as a model.

**Important** Always set the rotation parameters before executing automatic registration. Models will be automatically registered with the set angle range. Correct measurement is not possible if the rotation parameters are changed after automatic registration. Refer to 4-5-1 *Setting the Rotation Parameters*.

The automatic registration region is drawn as a combination of the following figures. A total of 10 figures can be drawn.

Figure type	Drawing method
B.Box	Specify two diagonally opposed corner points.
C.Circle	Specify the center, and then specify any point on the circumference.
A.Ellipse	Specify the center, and then specify any corner of the rectangle that circumscribes the ellipse.
T.Triangle	Specify the 3 vertices of the triangle.

The following two modes are available for drawing figures.

Drawing mode	Action
O.Draw(OR)	<p>Used to draw automatic registration regions. When several figures are drawn, a model is cut which incorporates all the figures as one automatic registration region.</p>
M.Mask(NOT)	<p>Used to partially delete automatic registration regions. When figure B drawn in mask mode overlaps figure A, the overlapped part is deleted. This part is not deleted if figure A overlaps figure B.</p>

When "D.Delete all" is selected all the drawn figures will be deleted.

Procedure

- 1, 2, 3... 1. Select "M.Model registration."
- 2. Select "A.Automatic registration." A confirmation message will be displayed.

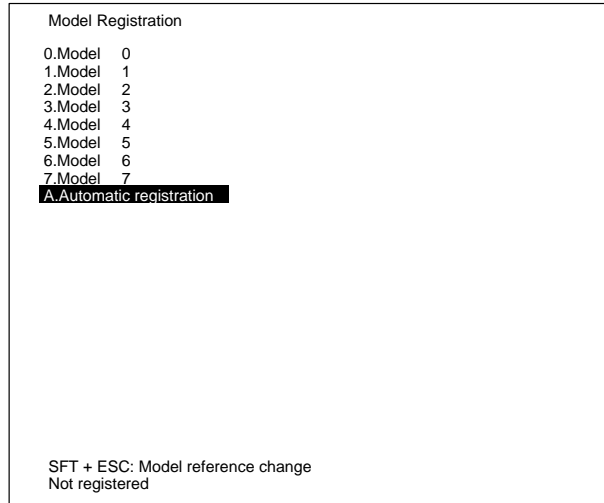

- 3. Confirm the rotation parameters and select "O.OK."

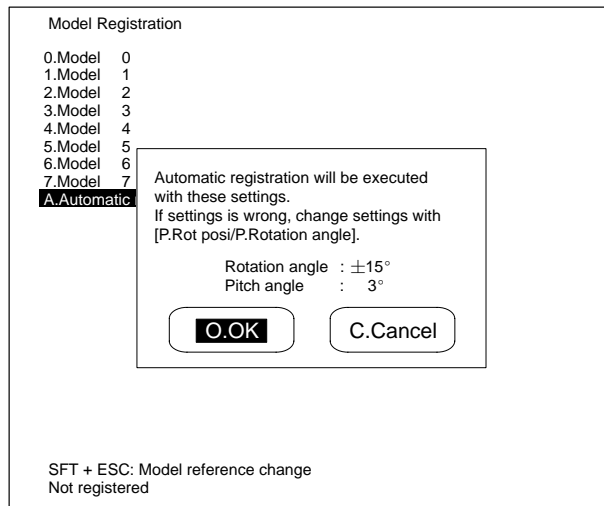

4. Select the number of models for automatic cutting.

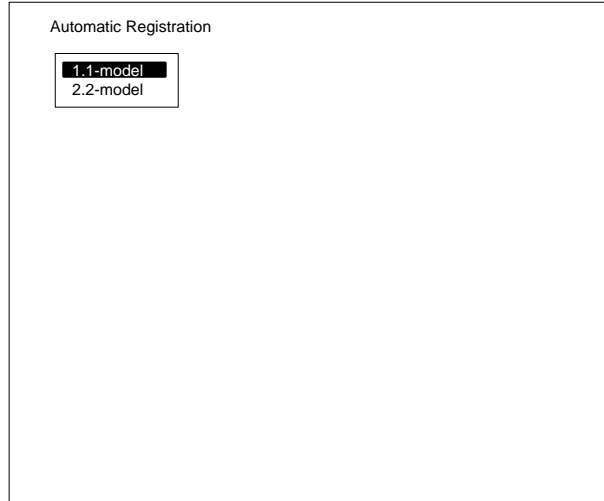

5. Input the registration model number for the cut model and select "E.End."

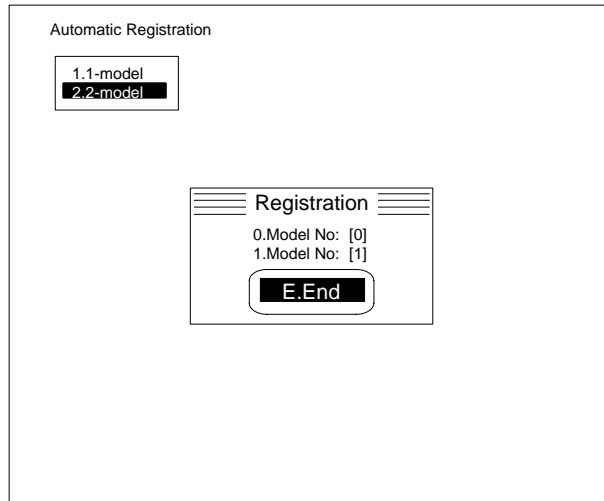

6. Select a figure.

7. Select a drawing mode.

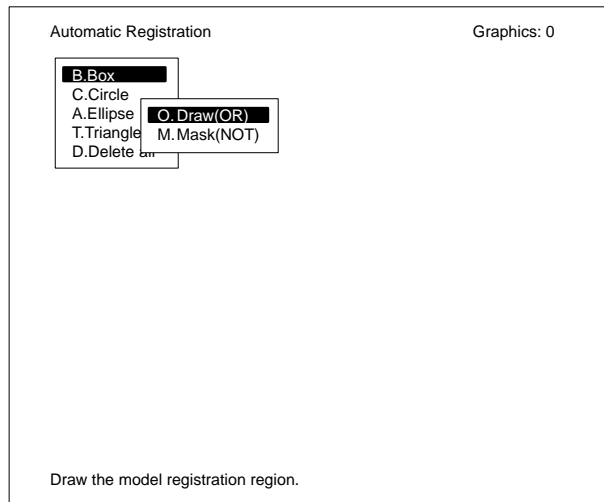

- 8. Draw the automatic registration region. When drawing several figures, repeat steps 6 to 8.

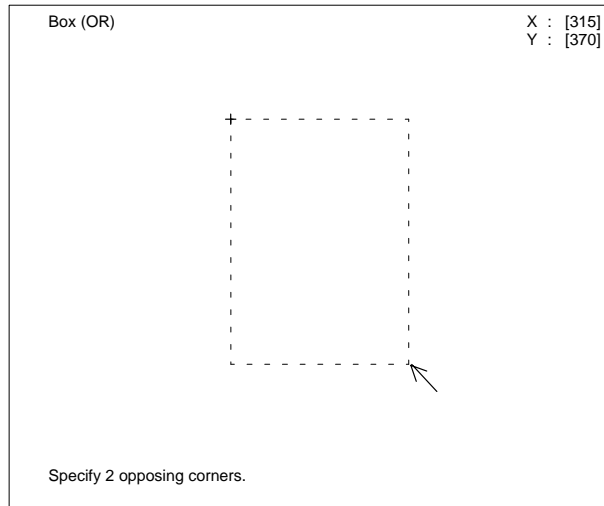

- 9. Press the Escape Key. A confirmation message will be displayed.

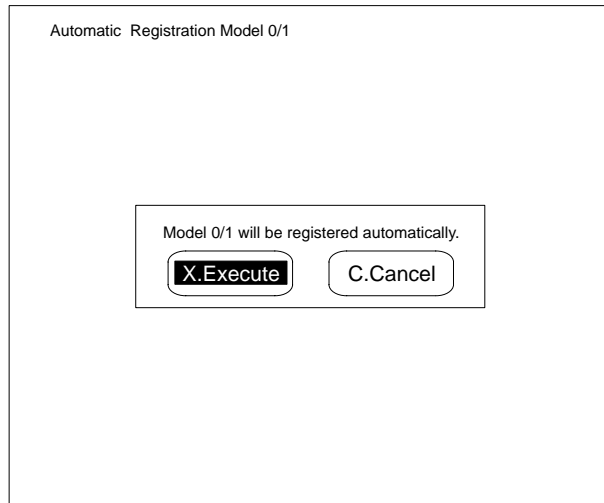

- 10. Select "X.Execute." Model frame will be displayed. To change the size of the model frame, go to step 11. When there are no changes, go to step 12.

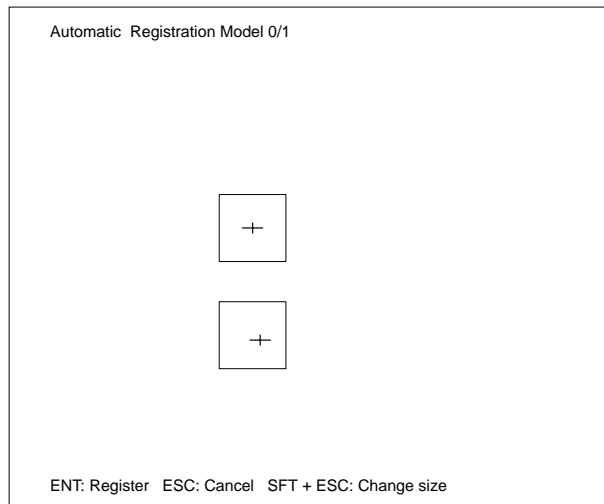



11. Press the Shift+Escape Keys. Change the size of the model frame.

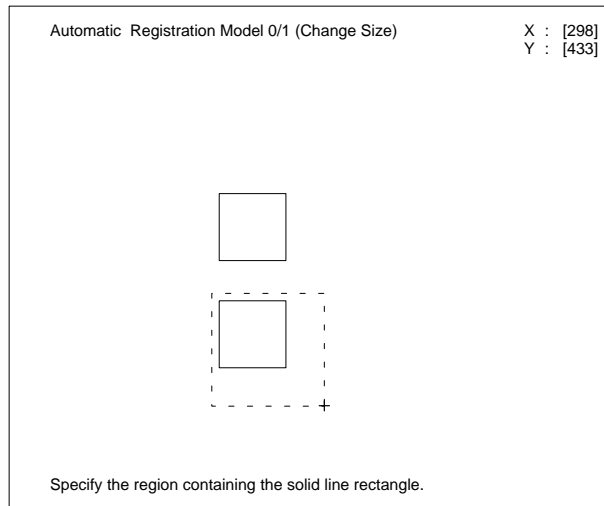

12. Press the Enter Key.

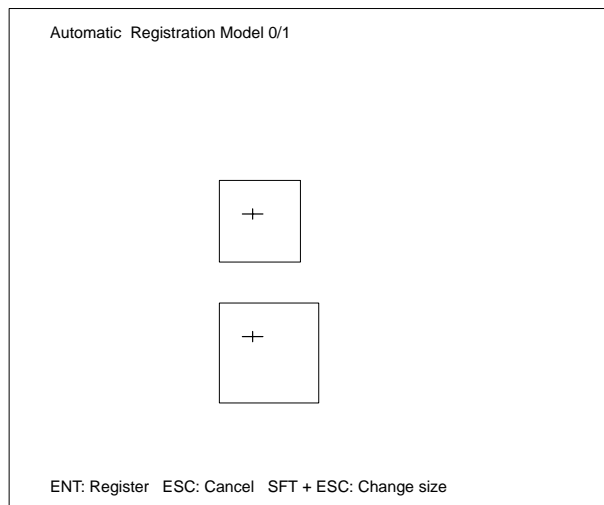

### 4-5-3 Two-model Pairings: 2.2-model Pairings

Two positions on a measurement object can be used as models for positioning. For example, when the measurement object is a rectangle, two opposing corner points can be used as models for positioning. In “2.2-model pairings” the relationship between two models (Reference and Relative models) is set. When two models cannot be viewed on one camera, use two cameras and view the models one at a time to execute positioning. The amount of displacement of the center of a line joining the two models is output.

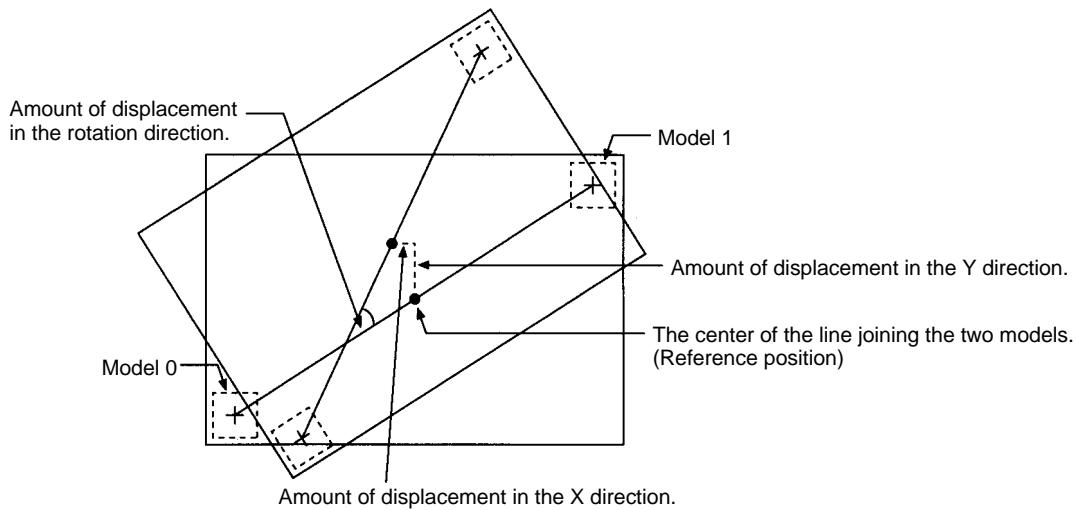

### Pairing Models

Select a reference model from the models registered for the current process number. Select the relative model from the models registered for the current process number or registered for the process number for which rotation positioning is set.

**Important** When a model registered for another process number is selected as the relative model, pair models so that the coordinate values of the relative model are greater than those of the reference model on actual coordinate system. If the coordinate values of the relative model are less than those of the reference model on actual coordinate system, set the relative model and the reference model after switching the process number.

Model orientation	Two-model pairings
Horizontal	Select the model with the smaller X value as the reference model. Select the model with the larger X value as the relative model.
Vertical	Select the model with the smaller Y value as the reference model. Select the model with the larger Y value as the relative model.

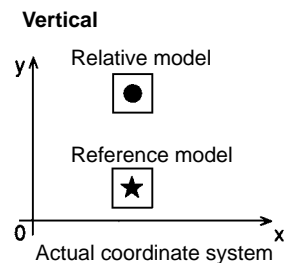
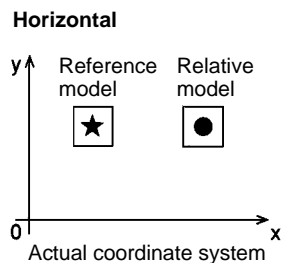

### Procedure

- 1, 2, 3...**
1. Select "2.2-model pairings." The pairings setting screen will be displayed.
  2. Select the setting number.

3. Select "R.Pairings."

Two-Model Pairings

	Proc	Model	Proc	Model	Distance (mm)	Direction
0.	1	0	1	1	R 439.810	
1.	1	0	1	5	R 294.478	
2.	1	2	1	1	R 314.213	
3.	1	0	2	0	R 224.154	<b>R. Pairings</b> D. Distance L. Clear
4.						
5.						
6.						
7.						

4. Select the model number for the reference model.

Two-Model Pairings (Reference Model)

**0.Model 0** 

1.Model 1

2.Model 2

3.Model 3

4.Model 4

5.Model 5

6.Model 6

7.Model 7

3: Process; Model -Process; Model  
SFT + ESC: Model reference change  
Filtering: Off BGS level: 0~255

5. Select the process number for the relative model.

Two-Model Pairings (Relative Process)

**1.Rotation positioning**

2.Rotation positioning

3: Process1; Model0 -Process; Model

6. Select the model number for the relative model. The pairings for the two models will be set.

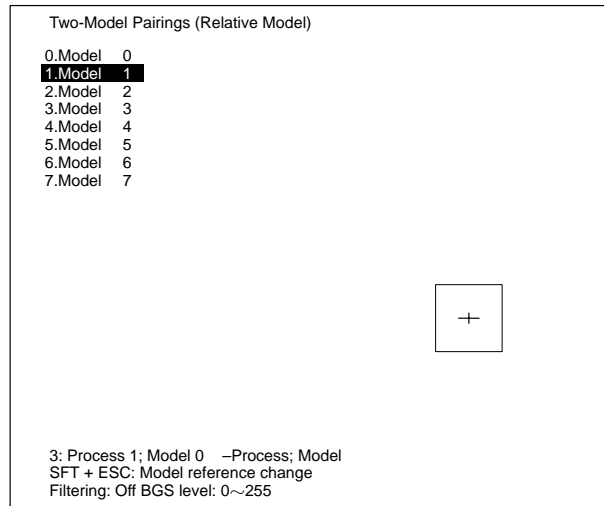

**Setting the Distance Between the Two Models**

This procedure sets the distance between the two models. Positioning is executing by calculating the displacement from the center of the line joining the two models, using the distance and rotation set here.

**Important When Pairing Two Models with Two Cameras**

The center coordinates of the line joining the two models cannot be output correctly if the coordinate system for each camera is different. Set “M.Method” to “User input value” and input the actual distance between the two models.

Item	Contents
M.Method	Measurement value: The position coordinates registered for the model are calculated using calibration data and the distance between the two models is automatically set. User input value :The actual distance between the two models is set.
D.Distance	When set on “Measurement value”: Set automatically. When set on “User input value”: Sets actual distance as a value from 0 to 999.999mm.
R.Direction	Sets the model’s orientation. Only set when the process numbers for the two models to be paired differs, and when “M.Method” is set to “User input value.” In all other instances, this setting is disregarded. Horizontal: When the two models for pairing are aligned horizontally. Vertical: When the two models for pairing are aligned vertically.

R.Direction: Horizontal

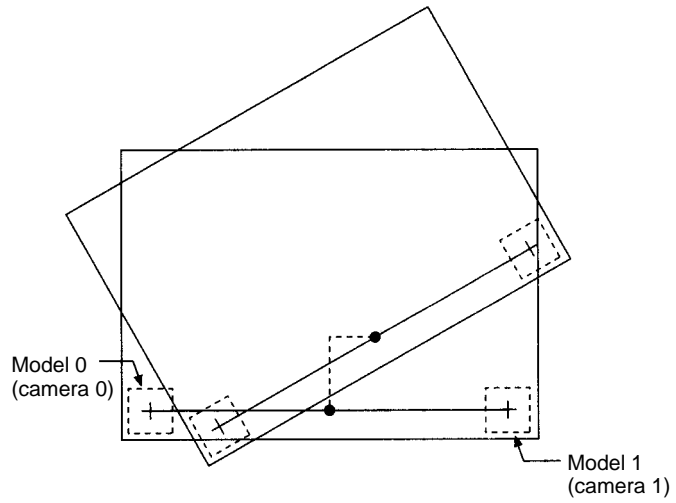

R.Direction: Vertical

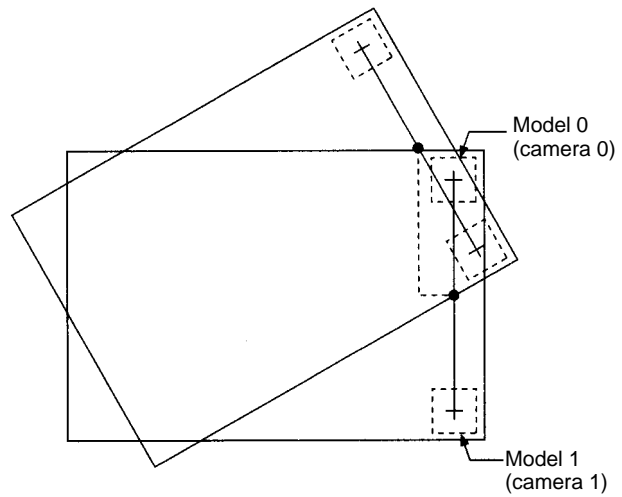

Procedure

- 1, 2, 3... 1. Select "2.2-model pairings." The pairings setting screen will be displayed.
- 2. Select the setting number.
- 3. Select "D.Distance."

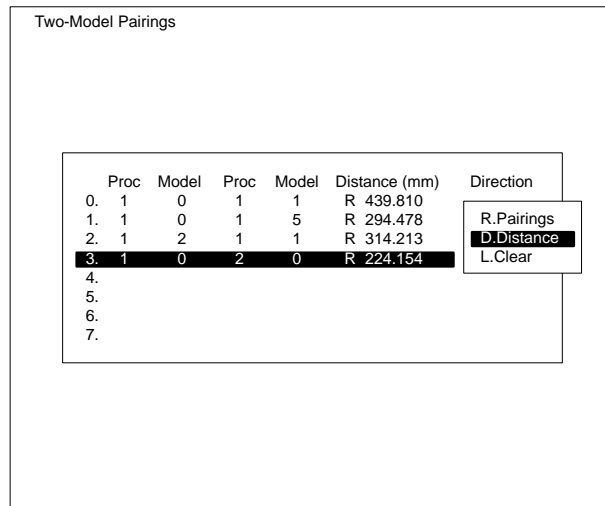

- 4. Set the distance.
- 5. Select "E.End."

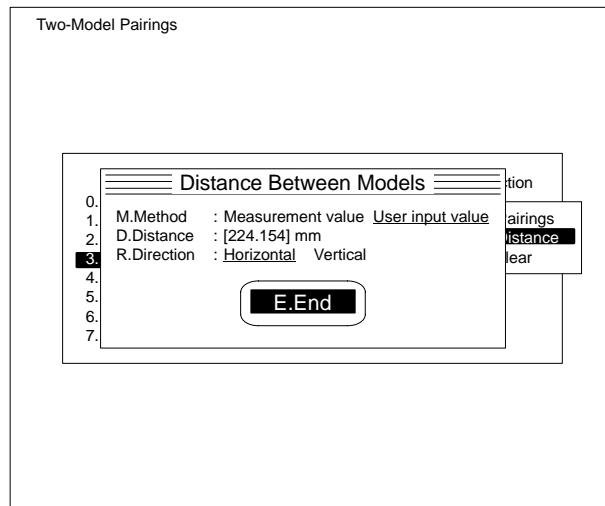

### Clearing the Two-model Pairings Settings

This procedure clears the pairings of the reference and relative models and returns all settings to the default values. Clear all settings which are not to be used for measurement.

**Procedure**

- 1, 2, 3... 1. Select "2.2-model pairings." The pairings setting screen will be displayed.
2. Select the setting number. The edit menu will be displayed.

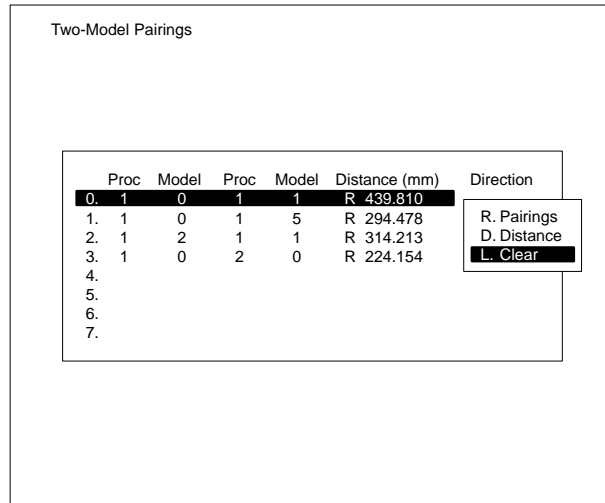

3. Select "L.Clear." A confirmation message will be displayed.
4. Select "X.Execute."

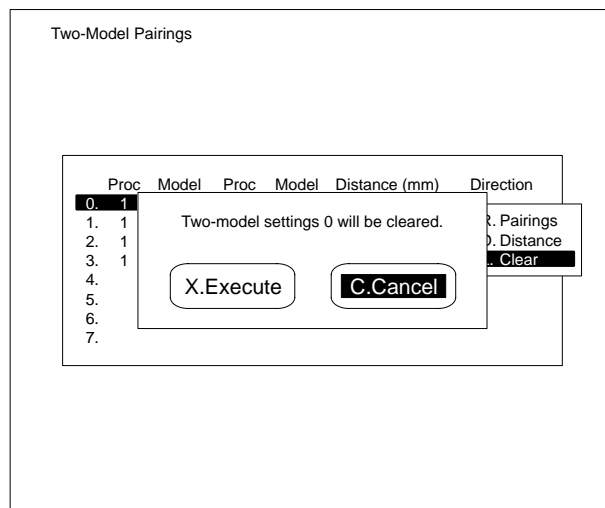

### 4-5-4 Setting the Output Conditions: O.Output Conditions

"O.Output conditions" sets the output method for the measured results. The model's displacement from the reference position can be output. The output values are changed to actual coordinate values, based on the calibration data, and output.

Item	Details
I.Individual	Select whether or not the measured results will be output, for each model. To output only the two-model pairing results, set "individual" to OFF.
U.Output device	Select the device to which the measured results will be output. The measured results will be output to the selected device and the Video Monitor.

Procedure

- 1, 2, 3... 1. Select "O.Output conditions."
- 2. Set the output conditions.
- 3. Select "E.End."

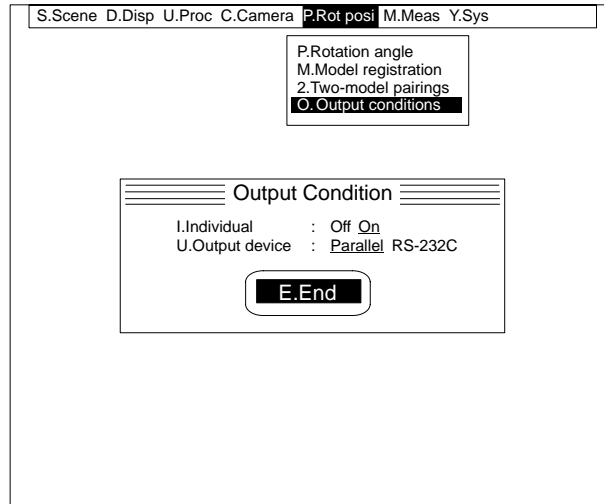

## 4-6 M.Measure/O.Measure Monitor

"M.Measure/O.Measure monitor" can be used to monitor measurement values and times before performing actual measurements. The criteria can also be changed, while referring to the measure value.

O.Measure monitor M.Measure	—	Checking Measurement Values and Measurement Times	Page 85
	—	Setting the Judgement Conditions	Page 88
	—	M.Measure/M.Measure	Page 124

### 4-6-1 Checking Measurement Values and Measurement Times: O.Measure Monitor

"O.Measure monitor" monitors measurement values based on the set data. Measured results are output to the Video Monitor only, even when a Parallel I/O Unit, Terminal Block Unit, or RS-232C Unit is mounted. The measurement time for each process is also displayed on the Video Monitor. When several processes are set, the measurement time for each can be monitored by switching between them.

**Important**

**Instruction Input Timing**

The next instruction must not be input while an instruction is being executed. Neither the instruction currently being executed nor the next instruction will be properly executed. When a Terminal Block Unit or Parallel I/O Unit is mounted, the BUSY signal will turn ON during instruction execution. Check to be sure that the BUSY signal is OFF before inputting the next instruction.



### Search Monitor

The current process number, the set measurement item name and the camera number.

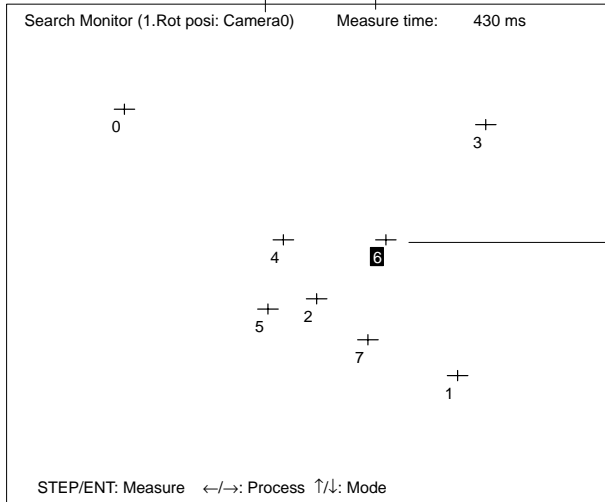

The measurement time for the current process.

When position compensation is set for the same camera number for the preceding process, the time displayed includes position compensation time.

When position compensation is set in succession, the time displayed includes the time for position compensation over several stages. This does not include the time for displaying the measured results on the video monitor.

In some cases, successive processes are processed in parallel. This means that the total of all separate process times will not necessarily equal the scene measurement time. Confirm the measurement time for each scene on the measurement screen.

Refer to 4-9-1 Entering Measurement Screens.

A cross cursor is displayed in the positions where models were found. The orientation of the cross cursor indicates the orientation of the model. Model numbers for which the correlation value is less than the criteria will be displayed in reverse video.

### Measure Value Monitor

The current process number, the set measurement item name and the camera number.

Measure Monitor (1.Rot posi: Camera0)      Measure time: 430 ms

No.	Reference		Displacement			Correlation
	Xmd	Ymd	X	Y	θ	R
0	75.000	54.000	0.745	-0.137	0.140	96.8 [70]
1	403.000	347.000	-0.206	0.104	0.010	98.8 [70]
2	94.000	290.000	172.095	1.380	-0.140	94.2 [70]
3	430.000	61.000	-0.256	0.559	-0.070	98.5 [70]
4	234.000	234.000	0.057	0.163	0.380	97.4 [70]
5	229.000	305.000	-0.022	0.193	-0.180	98.0 [70]
6	341.000	234.000	-0.116	-0.011	-0.330	97.8 [70]
7	324.000	322.000	-0.045	0.088	0.280	64.8 [70]
2model X md Y md X Y θ						
0-1	239.000	200.500	0.270	-0.016	0.106	
0-5	152.000	179.500	0.361	0.028	0.161	
2-1	248.500	318.500	85.945	0.742	11.726	

STEP/ENT: Measure ←/→: Process ↑/↓: Mode SFT + ESC: Conditions

The measurement time for the current process.

When position compensation is set for the same camera number for the preceding process, the time displayed includes position compensation time.

When position compensation is set in succession, the time displayed includes the time for position compensation over several stages. This does not include the time for displaying the measured results on the video monitor.

In some cases, successive processes are processed in parallel. This means that the total of all separate process times will not necessarily equal the scene measurement time. Confirm the measurement time for each scene on the measurement screen.

Refer to 4-9-1 Entering Measurement Screens.

The correlation value with the model is displayed in the range 0 to 100. When the correlation value is less than the criteria, it is judged NG and the value is displayed in reverse video.

The displacement between the model search positions and the reference model.

The reference position at the time the model was registered.

### Console

The following instructions can be input from the Console.

#### All Monitor Modes

Instruction	Key	Action
Measure	ENT	Executes measurement. When position compensation is set for the same camera number for the preceding process, the measurement is executed after position compensation.
Switch process	◀/▶	Switches the process and executes measurement items as set. Processes which have no set data are skipped. When position compensation is set for the same camera number for the preceding process, the measurement is executed after position compensation.
Switch mode	▲/▼	Switches the search, or measure value monitor mode.
Quit measurement	ESC	Quits the measure monitor screen.

#### Measure Value Monitor

Instruction	Key	Action
Condition settings	SHIFT + ESC	The judgement conditions can be changed while referring to the correlation values. Refer to 4-6-2 Setting the Judgement Conditions.

**RS-232C**

The following instructions can be input via the RS-232C. Attach a delimiter to the input code (ASCII). Ensure that it matches the communications specifications of the F350 and the external devices. Refer to 5-2-3 *Setting the RS-232C Communications Specifications* in the *F350 Setup Menu Operation Manual*.

**Important** Set the instruction delimiter to CR, or CR + LF. Always use channel 0. Channel 1 on the RS-232C I/F Unit cannot be used.

**Measure**

M	Delimiter
m	

Measurement is executed once. When position compensation is set for the same camera number for the preceding process, the measurement is executed after position compensation.

**Quit measurement**

Q	Delimiter
q	

Quits the measure monitor screen.

**Parallel I/O**

The following instruction can be input from a Parallel I/O Unit or Terminal Block Unit. Connect and wire the external devices. The leading edge (OFF to ON) of the STEP signal is indicated by ↓.

Refer to 2-4 *Connecting Peripheral Devices* in the *Setup Menu Operation Manual*.

Instruction	Input data STEP DI: 76543210	Action
Measure	↓	Executes a measurement one time in sync with the STEP signal's leading edge (OFF to ON). When position compensation is set for the same camera number for the preceding process, the measurement is executed after the position compensation.

**4-6-2 Setting the Judgement Conditions: O.Measure Monitor**

“O.Measure monitor” can be used to input model conditions, such as the criteria, while referring to the measure values. There are two methods for inputting the model conditions on the measure monitor. Select “Each model” to make changes to each model separately. Select “All” to make changes to all models consistent with those registered on the current process.

The correlation criteria is set as a number from 0 to 100. An items which matches the measurement model exactly is equal to a setting of 100. Select the level of precision for finding the measurement model's position during the search. The position of the measurement model is usually found in the unit below pixels (sub-pixels). To reduce the time required for measurement, set the precision to normal to output the measured results in pixels.

Measurement precision	Unit
Normal	Pixels
High	Subpixels

**Two Methods for Setting the Criteria**

Either “M.Model registration/C.Model conditions” or “M.Measure/O.Measure monitor” can be used. Whichever procedure is used, the most recently set data will take priority. For example, if the criteria are set to 75 using “M.Measure/O.Measure monitor” after they had been set to 80 using “M.Model registration/C.Model conditions”, the criteria will be 75. Refer to 4-5-2 *Registering the Measurement Model*.

Procedure

- 1, 2, 3... 1. Switch to the measure values monitor by pressing the Up and Down Keys.
2. Enter the Shift+Escape Keys. The screen for changing the procedure will be displayed.
3. Select a procedure. When "Each model" is selected carry out step 4. When "All" is selected go to step 5.

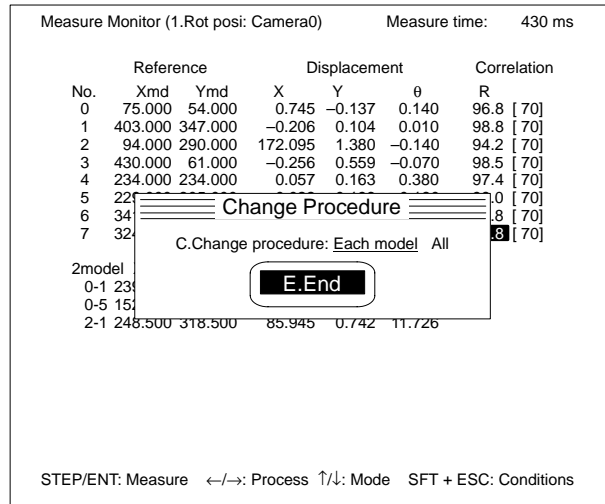

4. Select the model number for changes. Move the cursor to the where the model number for changes and press the Enter Key.
5. Set the correlation criteria and the measurement precision.
6. Select "E.End."

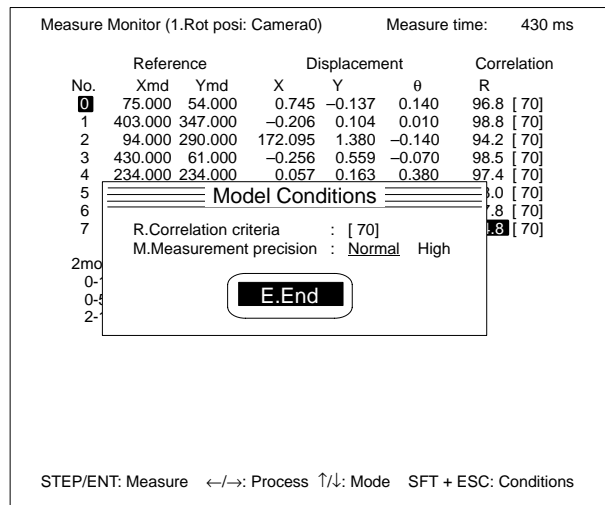

## ■ Position Compensation

Use position compensation when the position and orientation of the object to be measured are not fixed.

Position compensation must be set for a process number before it can be used. Refer to 4-3 U.Process.

When position compensation is used, the amount of deviation between the measurement object and the reference object is calculated and the image is automatically scrolled before the measurement is performed.

Select the camera number before setting the measurement conditions. Refer to 4-4-1 Selecting the Camera Number.

The following procedure is used to execute position compensation.

- 1, 2, 3...
1. The position compensation model is registered. The registered position will be used as the reference position.
  2. The model is searched for in the input image.
  3. The displacement between the position where the model was found and the reference position is calculated.
  4. The image is scrolled by the calculated displacement.
  5. A measurement is executed after position compensation has been completed.

## 4-7 P.Position Compensation

“P.Position Compensation” sets the data for position compensation.

- Two stages of position compensation can be executed for each camera. Even when the rotation range is 360°, high-speed position compensation can be executed by reducing the number of registered rotation models.
- When images of multiple workpieces are input by a single camera, position compensation can be executed for the respective workpieces. Refer to 4-3-1 Setting Measurement Items.

R.Registration	_____	Selecting the Position Compensation Mode	Page 90
T.Rotation angle	_____	Selecting the Rotation Compensation Parameters	Page 115
A.Region	_____	Setting the Position Compensation Region	Page 117
P.Speed	_____	Selecting the Position Compensation Speed	Page 118
C.Conditions	_____	Selecting the Position Compensation Conditions	Page 119
S.Reference	_____	Checking the Set Data	Page 120

### 4-7-1 Selecting the Position Compensation Mode: R.Registration

Select the mode for position compensation and register a reference model in order to determine the amount of displacement. There are three modes of position compensation.

- **One-model Positioning**  
One feature (corner or mark) on the measured object is used to determine the position and rotation of the object.
- **Two-model Positioning**  
Two features are connected, and the center coordinates of the lines joining these features between these lines are used to determine the position (including rotation).
- **Circle Positioning**  
Four points on the circumference of a circular workpiece are used to determine the position of the workpiece (including rotation).

When selecting a new position compensation mode or to change a previously set position compensation mode, set the position compensation settings.

Item	Details
0.Search verification	<p>Searches for position compensation models inside the search region for candidates. Verifies whether or not these candidates are correct.</p> <p>Required Register any size model. This is called the verification model. The rectangular region containing the features will be cut automatically from the region specified as the model. This is called the search model.</p> <ol style="list-style-type: none"> <li>1. "0.Search Verification" searches for search models inside the search region and detects candidates. All candidates with correlation values greater than the criteria will be detected. Set the criteria for detecting candidates in "P.Position compensation/C.Conditions." Refer to <i>Section 4-7-5 Setting the Position Compensation Conditions</i>.</li> <li>2. For each candidate, verification is executed using the verification model and positions with the highest correlation values are found.</li> </ol> <p>Although high-accuracy position compensation can be executed, the processing speed will become slower depending on the verification model used. Refer to <i>4-8 M.Measure/O.Measure Monitor</i>.</p> <p>Not required Register any size model. This is called the search model. Search models are searched for in the search region and positions with the highest correlation values will be found.</p>
1.Auto-registration	Automatically cuts the region most suitable for position compensation and registers it as a position compensation model. If circle positioning is selected as the position compensation mode, however, automatic registration cannot be performed. Set to "No."

### One-model Positioning

One-model positioning registers one characteristic part of the workpiece as a model. The model is searched for in the position compensation region. The displacement (X,Y) is detected between the reference position coordinates and the coordinates with the highest correlation to the model, and the image scrolls by the detected amount of displacement. The registered position of the model is set as the reference position.

The rotation model must be registered to execute rotational position compensation ( $\theta$ ). Refer to *4-7-2 Selecting the Rotation Compensation Parameters*.

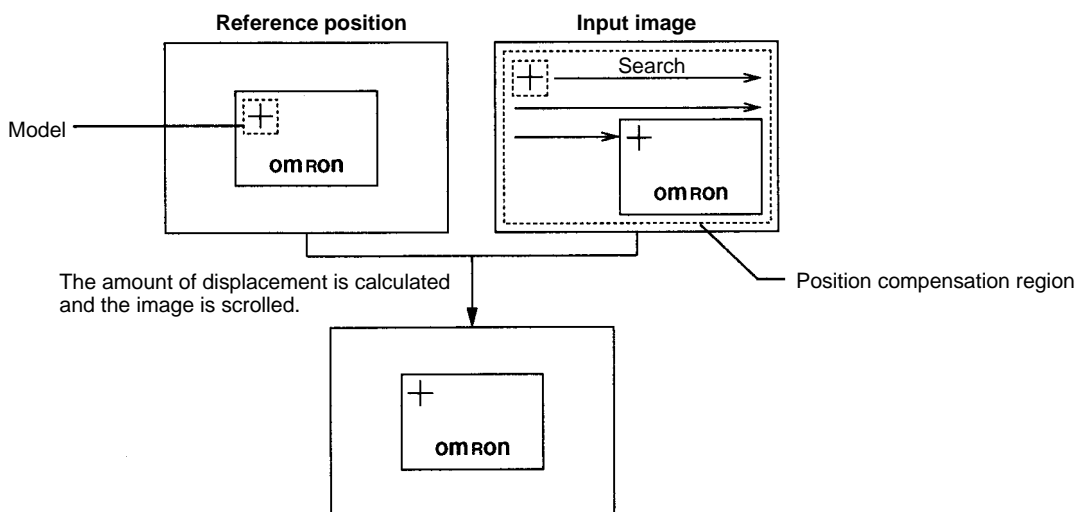

**Important** Correct measurement is not possible if the filtering and background suppression levels used during measurement are different from those that were used when the model was registered. Set the required filtering and background suppression levels for each camera number before registering models. Refer to *4-4-2 Selecting Filtering* and *4-4-3 Setting Background Suppression Levels*.

**Automatic Model Registration**

When “1.Auto-registration” is set to “Yes” on the settings screen, the most suitable region for position compensation will be cut automatically and can be registered as a position compensation model.

**Important** Set the search correlation values before registering the models. Refer to 4-7-5 *Selecting the Position Compensation Conditions*.

To detect the direction of rotation of the measurement object, execute automatic model registration using the following procedure.

- 1, 2, 3... 1. Register the provisional model. Either automatic or manual registration can be used.
2. Set the rotation angle and the pitch angle of the rotation model. Refer to 4-7-2 *Selecting the Rotation Compensation Parameters*.
3. Execute automatic model registration once the model is in the correct position. If the rotation angle or the pitch angle are changed after auto-registration, measurement will be incorrect.

The automatic registration regions are drawn as a combination of the following figures. A total of 10 figures can be drawn.

Figure type	Drawing method
B.Box	Specify 2 opposing corners.
C.Circle	After specifying the center of the circle, specify any point on the circumference.
A.Ellipse	After specifying the center of the circle, specify any corner of the circumscribing rectangle.
T.Triangle	Specify the 3 vertices of the triangle.

To draw these figures, select a drawing mode: Draw or Mask.

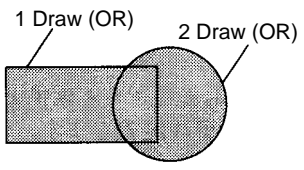
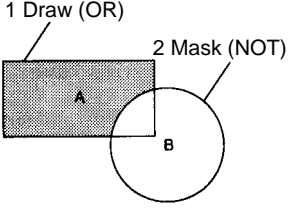
Drawing mode	Action
O.Draw (OR)	 <p>Use this mode when drawing the automatic registration region. The region drawn will be set as the automatic registration region. When several figures are drawn, a model can be cut which incorporates all the figures as one automatic registration region.</p>
M.Mask (NOT)	 <p>Used to delete one section of an automatic registration region. If figure B is drawn over the existing figure A using the mask mode, the contents of figure B will be deleted. If figure A is drawn after figure B has been drawn using mask mode, the contents of figure B will not be deleted.</p>

When “D.Delete all” is selected all the drawn figures can be deleted.

**Procedure**

- 1, 2, 3... 1. Select "R.Registration." Position compensation mode will be displayed.
- 2. Select "1.1-model positioning." When the position compensation mode needs to be changed, carry out steps 3 and 4. When the mode is already set to "1.1-model positioning," go to step 5.

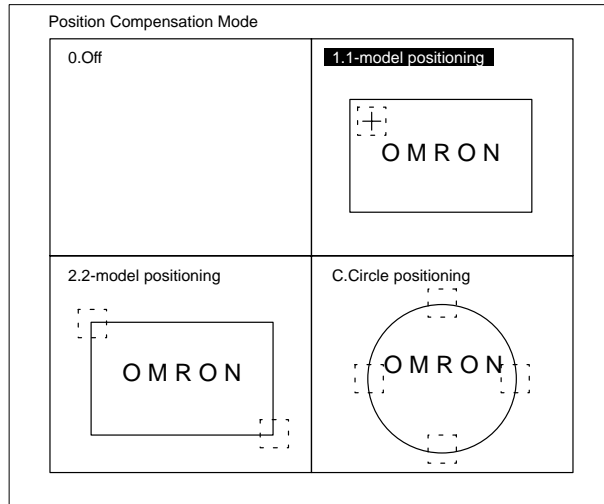

- 3. Select "X.Execute."

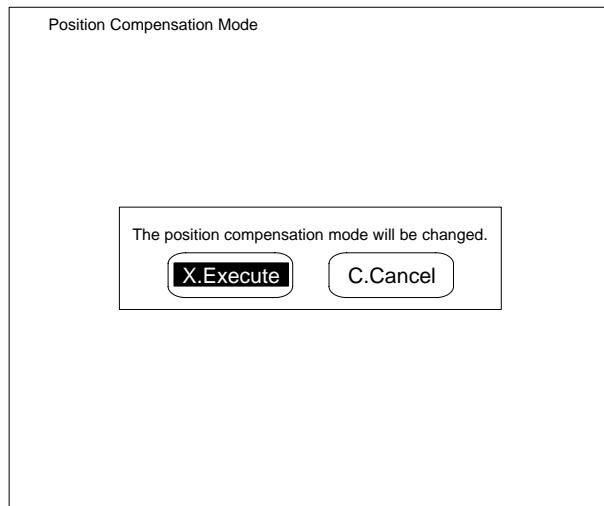



- 4. Set the position compensation settings. Set "1.Auto-registration" to "Yes."  
Set "0.Search verification" to "Required" or "Not required."

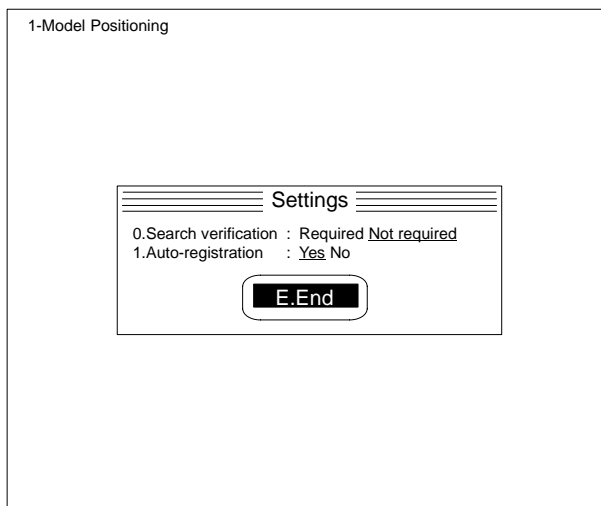

- 5. Select "A.Automatic registration."  
When modifying an automatically registered model, select "M.Model." Refer to page 96 "Manual Model Registration" for operating procedures.

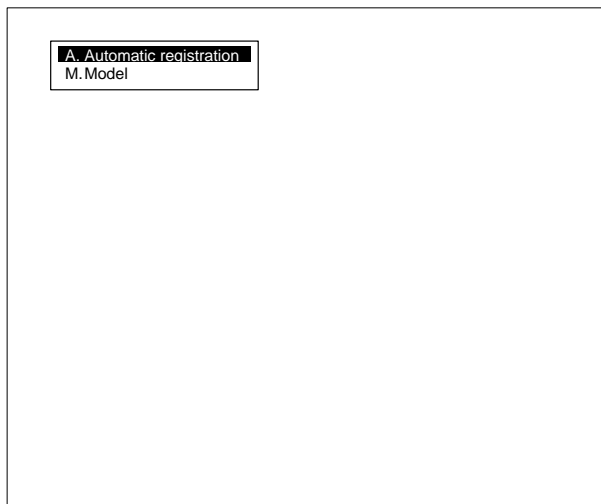

- 6. Select a figure.
- 7. Select a drawing mode.

8. Draw the automatic registration region. When drawing several figures repeat steps 6 to 8.

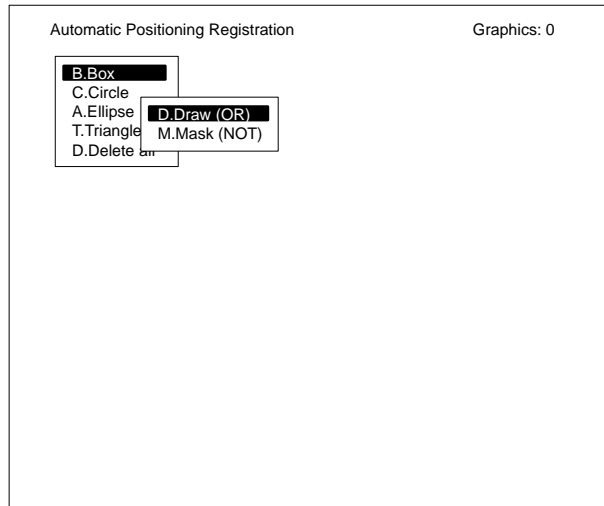

9. Press the Escape Key. A confirmation message will be displayed.
10. Select "X.Execute." The appropriate region for the position compensation model will be automatically cut and registered.

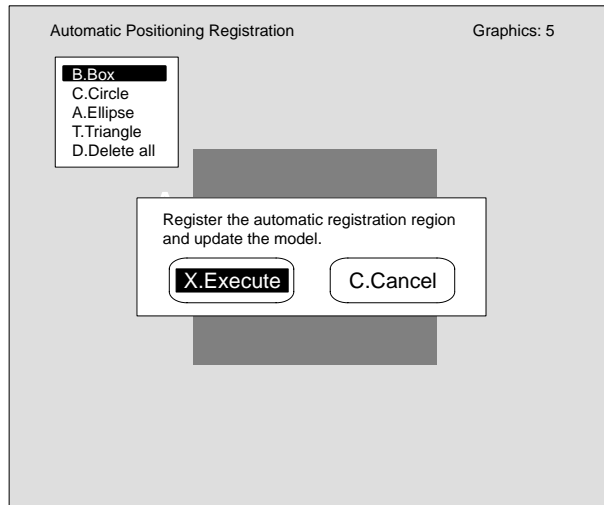

**Manual Model Registration** Set the region to be registered as the model.

**Procedure**

- 1, 2, 3... 1. Select "R.Registration."
- 2. Select "1.1-model positioning." When the position compensation mode needs to be changed , carry out steps 3 and 4. When the mode is already set to "1.1-model positioning" go to step 5.

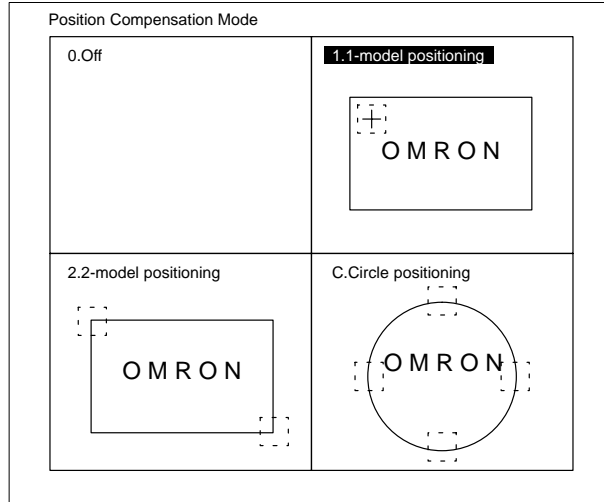

- 3. Select "X.Execute."

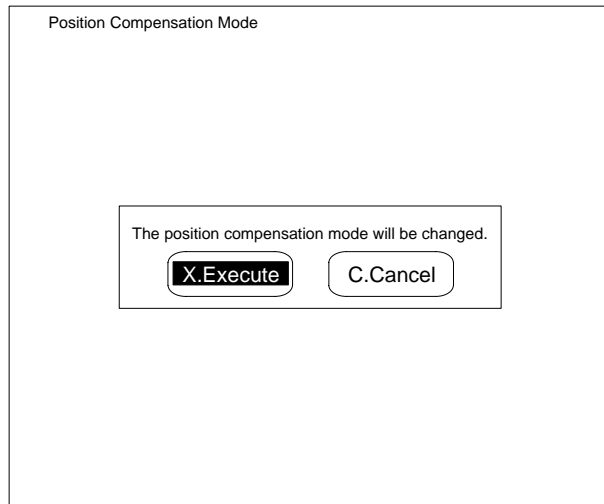

- 4. Set the position compensation settings. Set "1.Auto-registration" to "No." Set "0.Search verification" to "Required" or "Not required."

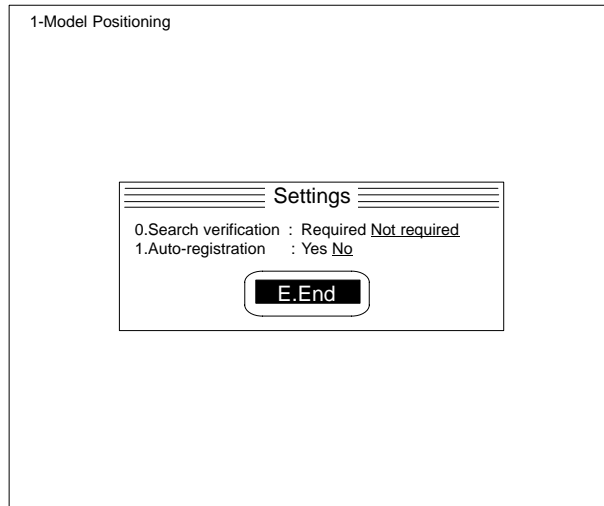

- 5. Set the top-left coordinates of the region to be registered as the model by moving the arrow cursor and pressing the Enter Key.
- 6. Set the bottom-right coordinates of the region to be registered as the model by moving the arrow cursor and pressing the Enter Key.

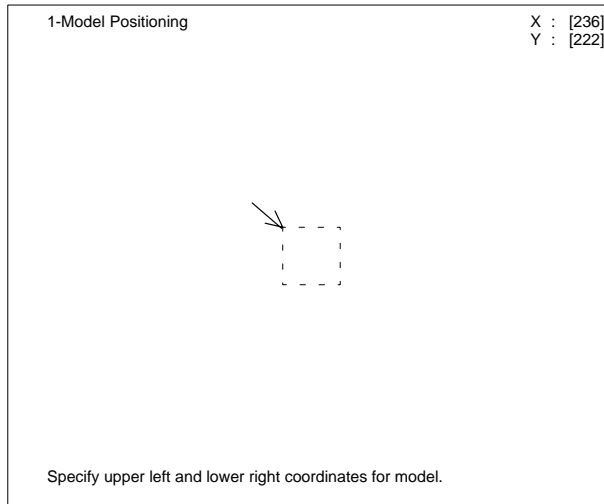

- Before registering the model, confirm that the measurement object is in the correct position. Press the Enter Key. The image in the specified region will be registered as the model.

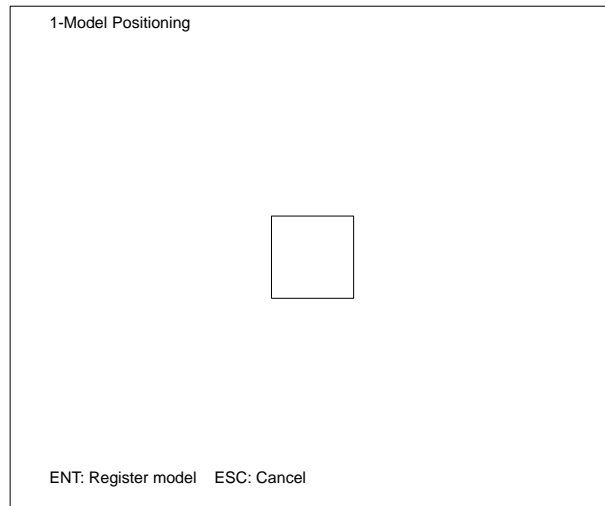

### Two-model Positioning

Two-model positioning registers two characteristic parts of the workpiece as the models and searches within each position compensation region for these models. Positions with high correlation values to models 0 and 1 (the center point of the models) are searched for. The displacement (X,Y,) is detected between the coordinates of the center of the line joining the centers of models 0 and 1 and the coordinates of the center of the reference position. The image scrolls by the detected amount of displacement.

A rotation model must be registered to execute rotational position compensation. A rotation model with the same angle as models 0 and 1 is used to search for positions (the center of the models) with the highest correlation value. The amount of displacement (X,Y,θ) between the coordinates of the center of the line joining the models and the reference position coordinates is detected. The image scrolls by the detected amount of displacement.

The registered position of the model becomes the reference position.

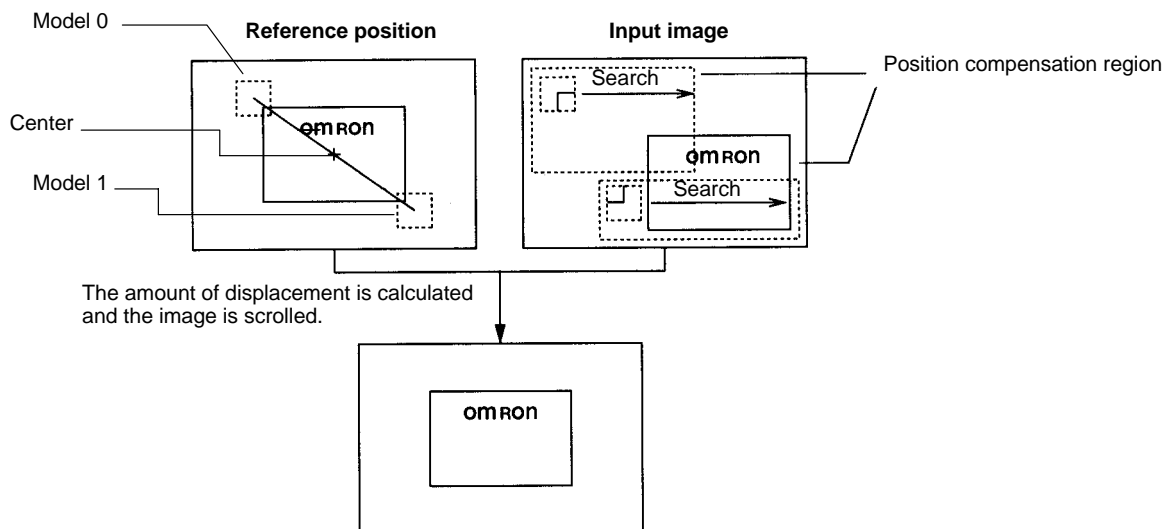

**Important** Correct measurement is not possible if the filtering and background suppression levels used during measurement are different from those that were used when the model was registered. Set the required filtering and background suppression levels for each camera number before registering models. Refer to 4-4-2 *Selecting Filtering* and 4-4-3 *Setting Background Suppression Levels*.

**Automatic Model Registration**

When “1.Automatic registration“ is set to “Yes” on the position compensation setting screen, the most suitable region for position compensation will be cut automatically and can be registered as a position compensation model. For the registration procedure refer to *One-model Positioning*.

**Manual Model Registration**

Set the region to be registered as the model.

**Procedure**

- 1, 2, 3... 1. Select “R.Registration.”
2. Select “2.2-model positioning.” When the position compensation mode to be changed , carry out steps 3 and 4. When the mode is already set on “2.2-model positioning” go to step 5.

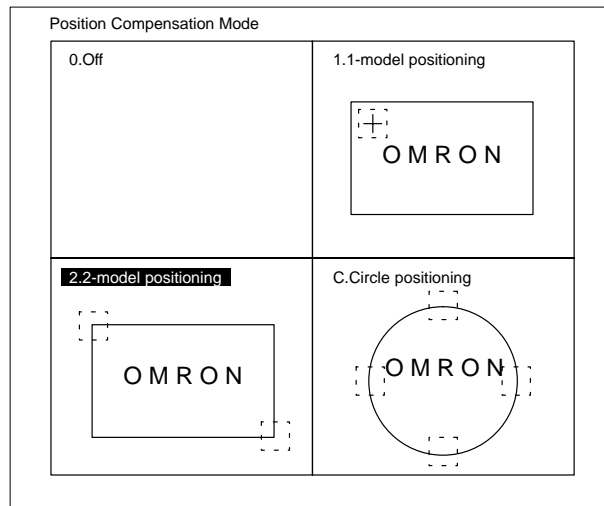

3. Select “X.Execute.”

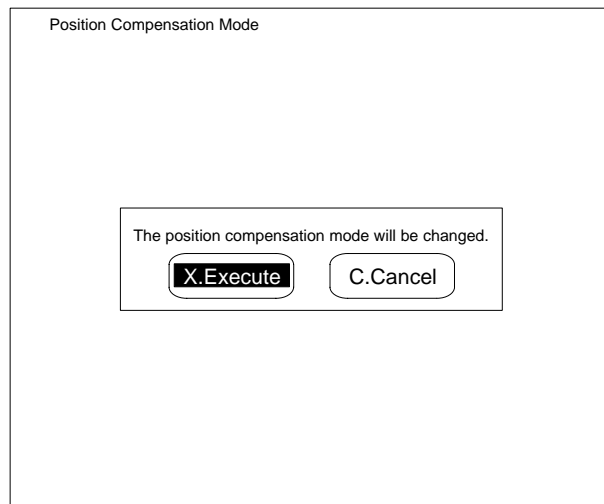

4. Set the position compensation settings. Set "1.Auto-registration" to "No."  
Set "0.Search verification" to "Required" or "Not required."

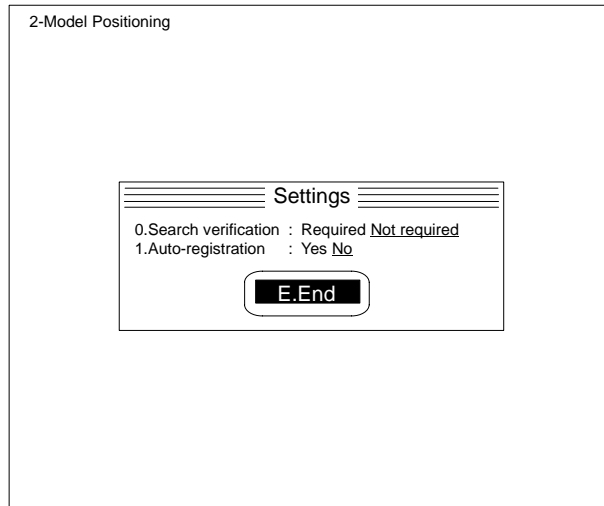

5. Set the top-left coordinates of the region registered as model 0.  
Move the arrow cursor and press the Enter Key.
6. Set the bottom-right coordinates of the region registered as model 0.  
Move the arrow cursor and press the Enter Key.
7. Specify the region to be registered as model 1 in the same way as for model 0.

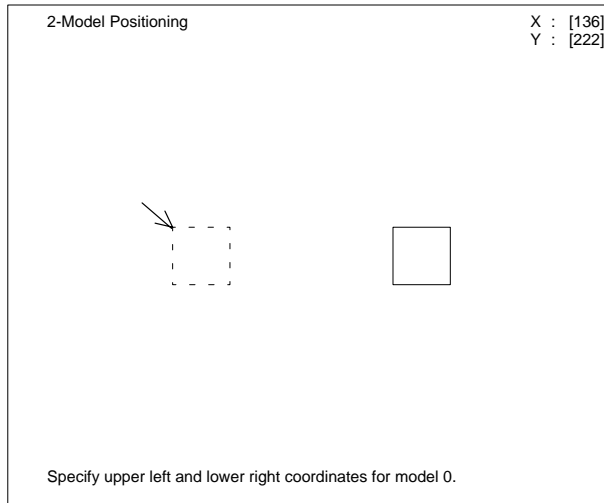

- Press the Enter Key. The images in the specified region will be registered as the models.

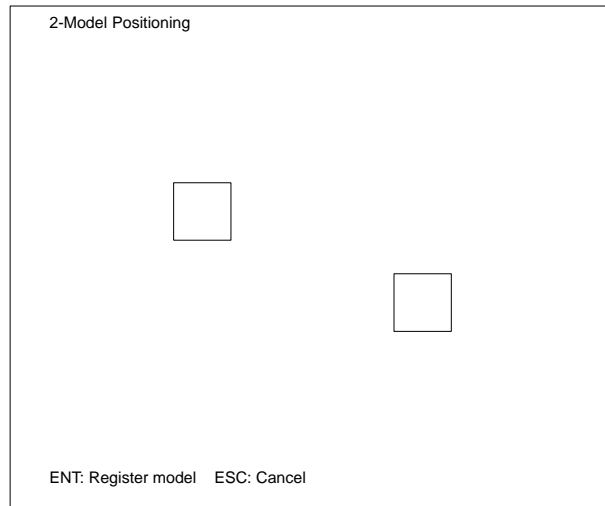

### Circle Positioning

Circle positioning registers four regions on the workpiece circumference as models. Positions with the highest correlation values to each model (the center of the models) are searched for. The center coordinates (X,Y) of the circle are detected from the position of these 4 models, and the image scrolls by the detected amount of displacement. Rotational position compensation can also be executed. The registered position of the model becomes the reference position.

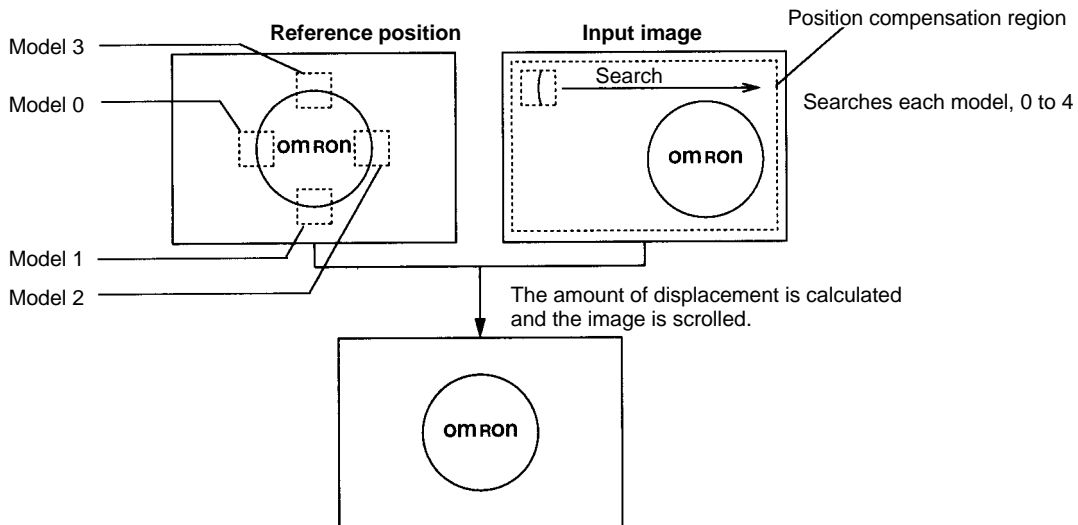

**Important** Correct measurement is not possible if the filtering and background suppression levels used during measurement are different from those that were used when the model was registered. Set the required filtering and background suppression levels for each camera number before registering models. Refer to 4-4-2 *Selecting Filtering* and 4-4-3 *Setting Background Suppression Levels*.



**No Rotation**

Only X,Y direction position compensation is executed.

**Procedure**

- 1, 2, 3... 1. Select "R.Registration."
- 2. Select "C.Circle positioning."

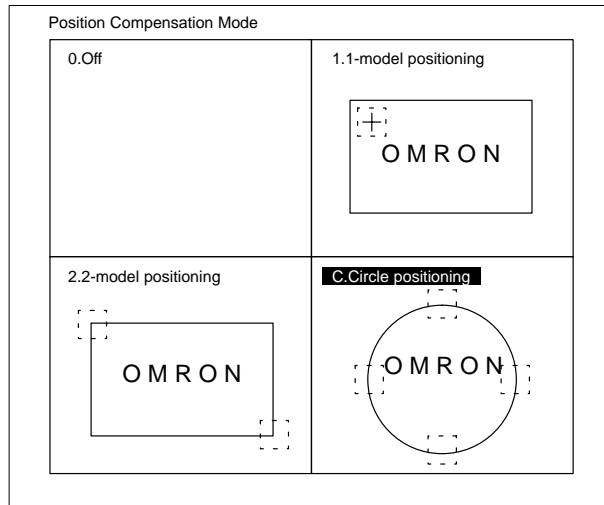

- 3. Select "0.No rotation." When the position compensation mode needs to be changed, carry out steps 4 and 5. When the mode is already set on "0.No Rotation" go to step 6.

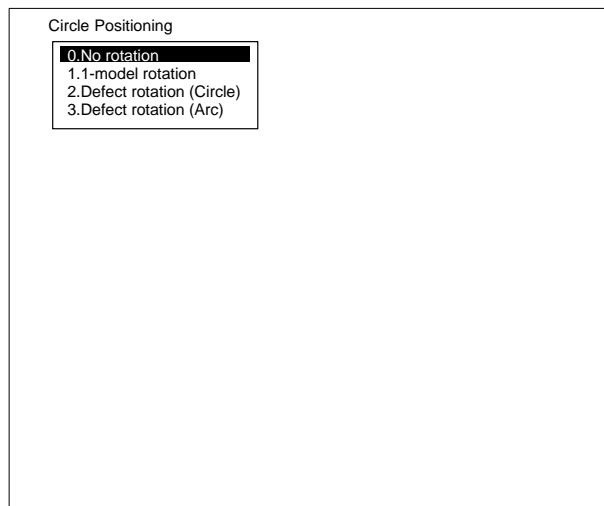

4. Select "X.Execute."

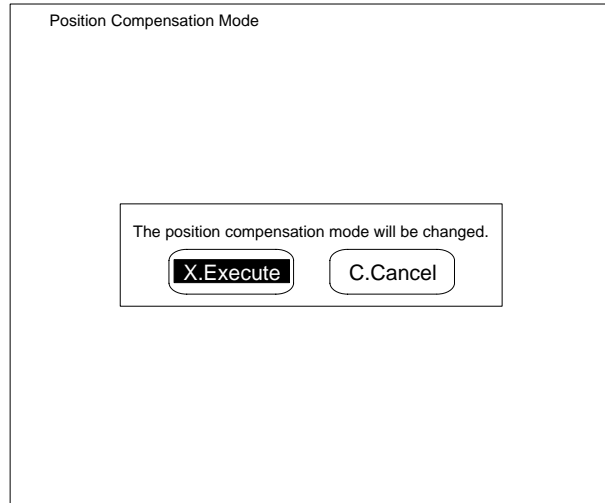

5. Set the position compensation settings. Set "1.Auto-registration" to "No." Set "0.Search verification" to "Required" or "Not required."

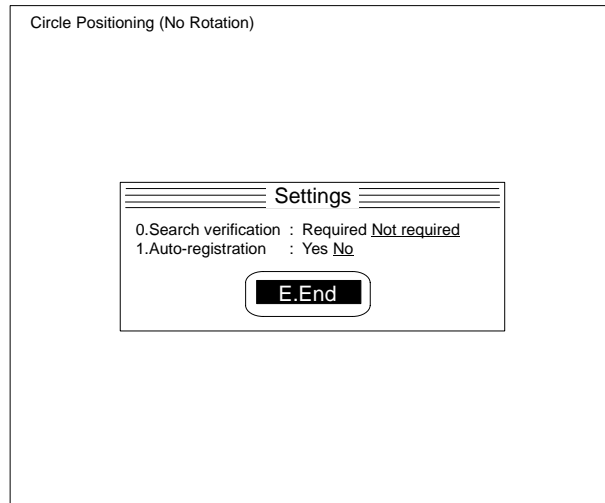

6. Specify the center of the circle by moving the cross cursor and pressing the Enter Key.

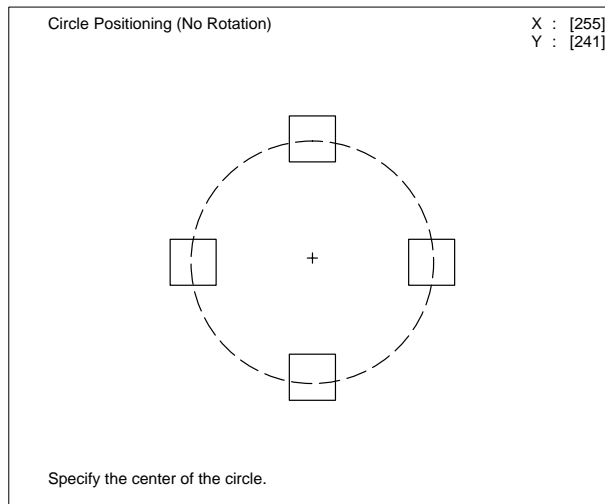

- 7. Specify the radius of the circle by moving the arrow cursor and pressing the Enter Key.

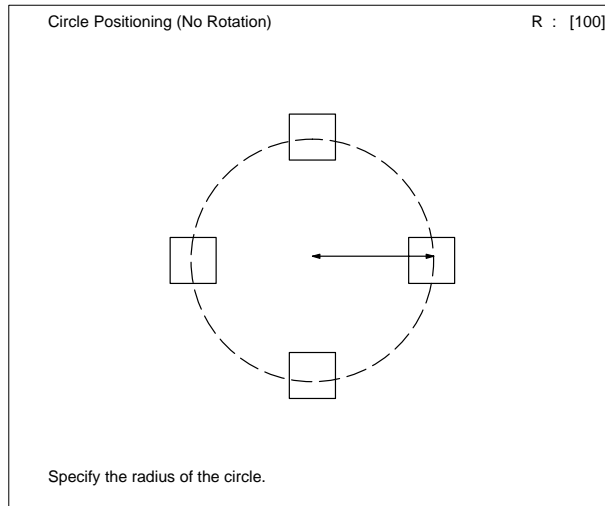

- 8. Specify the model size. Only model 0 will be displayed in the dotted line frame. When the arrow cursor is moved, the size of all models will change. Press the Enter Key.

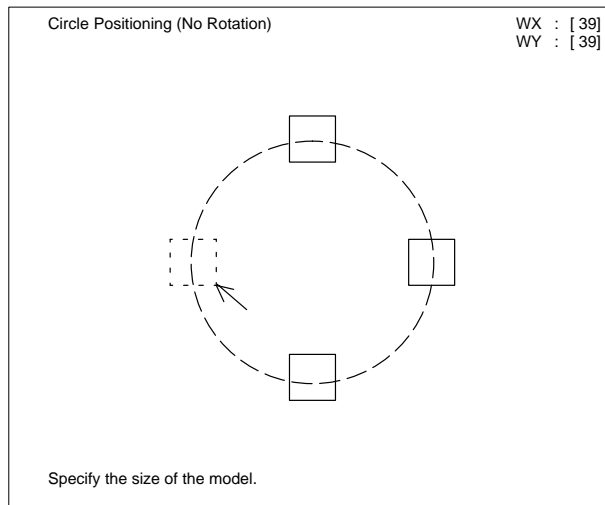

9. Press the Enter Key. The images of the four specified regions will be registered as models.

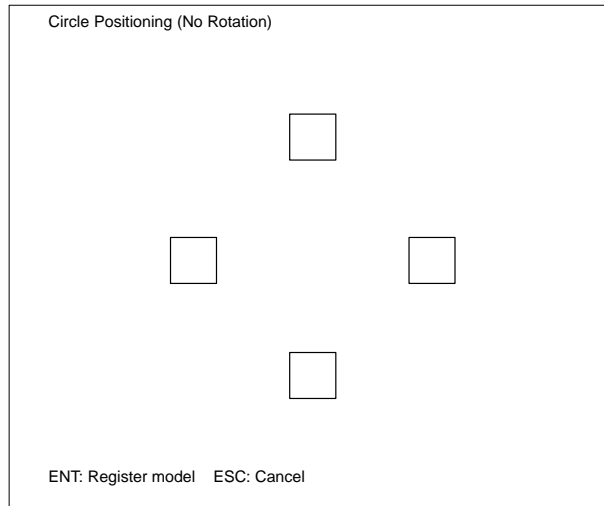

**One-model Rotation**

One-model rotation executes position compensation for the X , Y and the rotation directions. When the measurement object (the circle) rotates, any mark on the circle is registered as the rotation model. Rotational direction compensation can be determined from the angle formed by a line joining the position of the mark and the center of the circle.

Set the rotation angle and the pitch angle of the rotation model. Refer to 4-7-2 *Selecting the Rotation Compensation Parameters*.

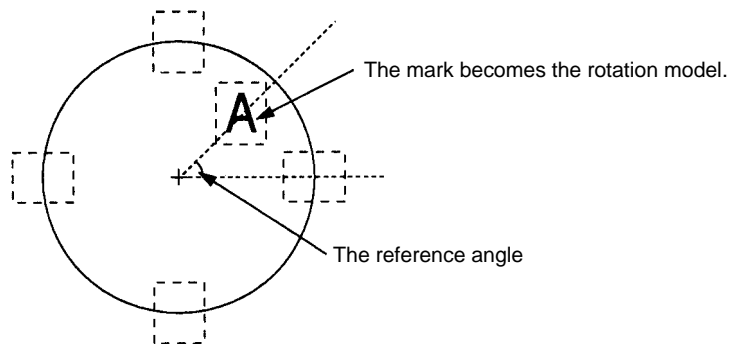

**Note** Greater stability is possible in position compensation if the rotation model is registered as far away from the center as possible.

Procedure

- 1, 2, 3... 1. Select "R.Registration."
- 2. Select "C.Circle positioning."

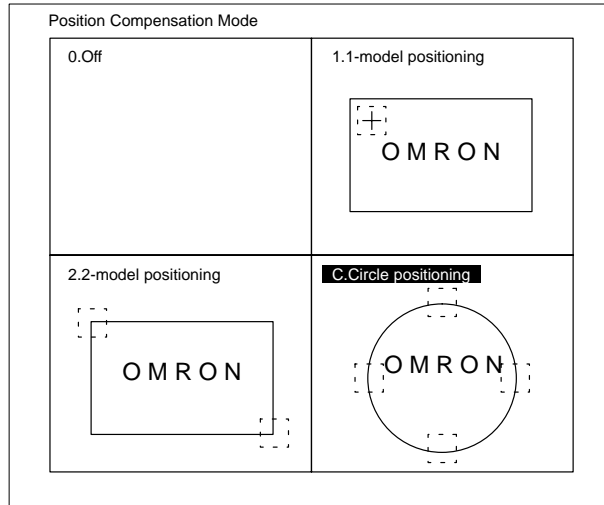

- 3. Select "1.1-model positioning." When the position compensation mode needs to be changed , carry out steps 4 and 5. When the mode is already set on "1.1-model rotation" go to step 6.

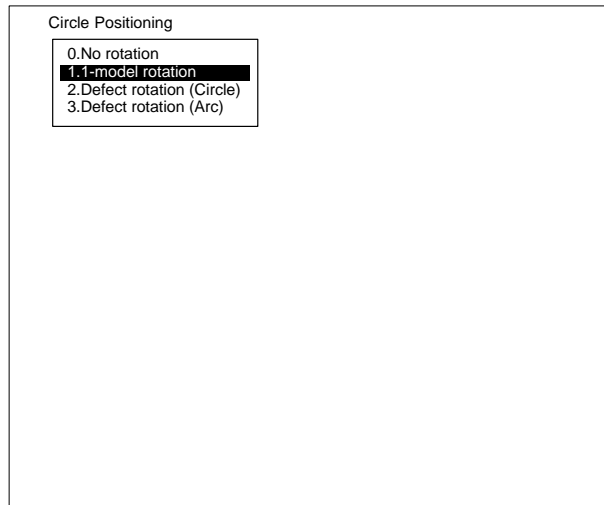

4. Select "X.Execute."

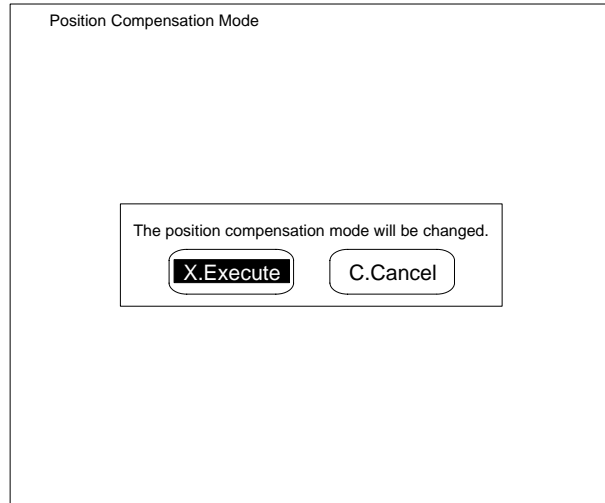

5. Set the position compensation settings. Set "1.Auto-registration" to "No." Set "0.Search verification" to "Required" or "Not required."

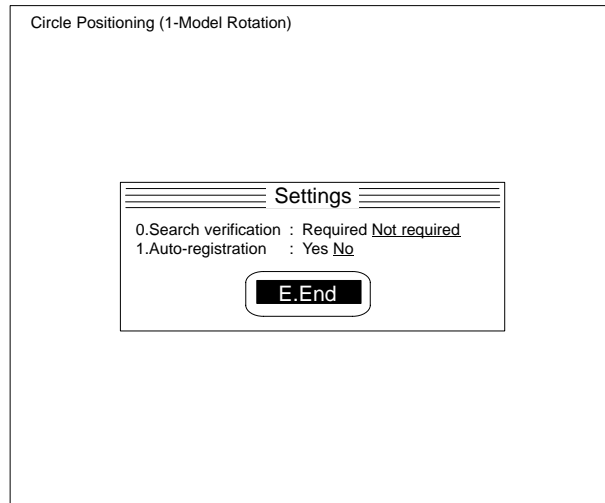

6. Specify the center of the circle. Move the cross cursor and press the Enter Key.

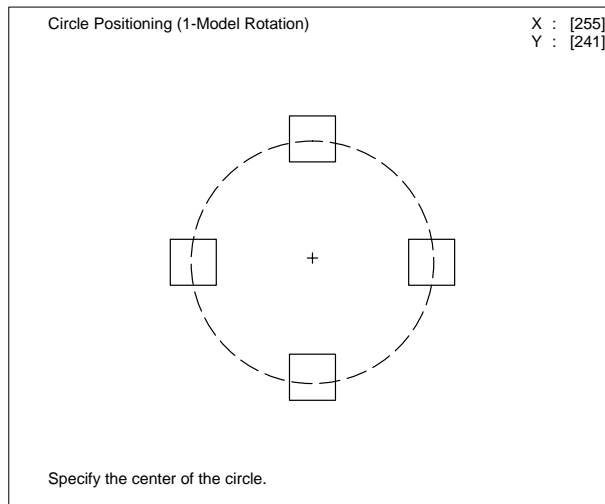

- 7. Specify the radius of the circle. Move the arrow cursor and press the Enter Key.

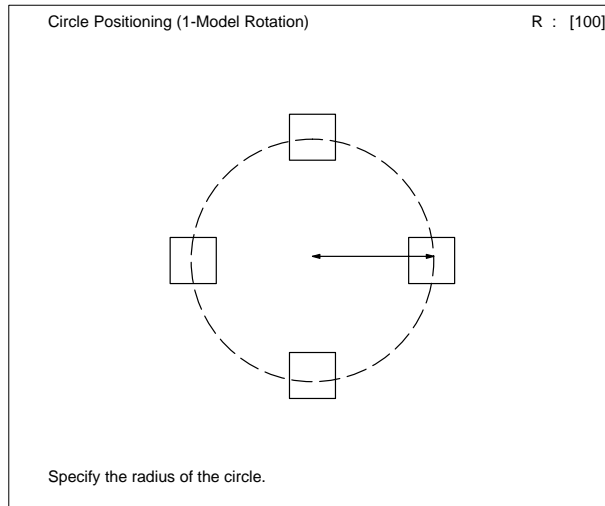

- 8. Specify the size of the model. Only model 0 will be displayed in the dotted line frame. When the arrow cursor is moved and the size of models 0 to 3 will be changed. Press the Enter Key.

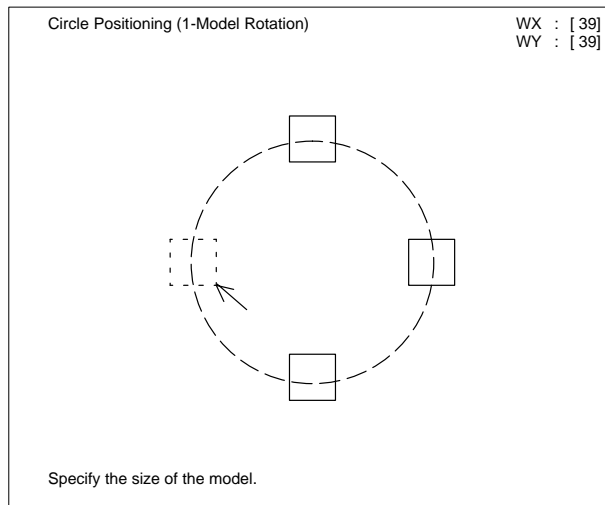

- 9. Specify the top-left coordinates of the region to be registered as model 4 (the rotation model). Move the arrow cursor and press the Enter Key.

- 10. Specify the bottom-right coordinates of the region to be registered as model 4.  
4. Move the arrow cursor and press the Enter Key.

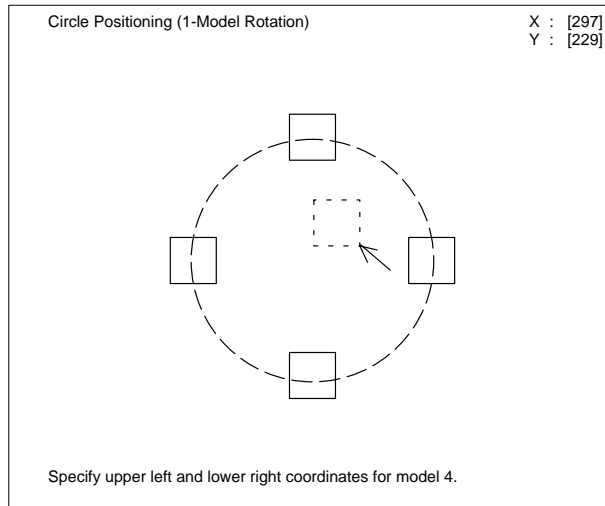

- 11. Press the Enter Key. The images of the five specified regions will be registered as models.

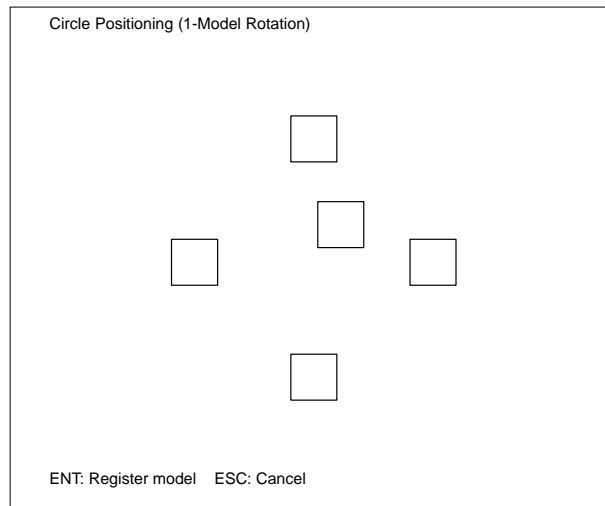



**Defect Rotation: Circle/Arc**

Defect rotation executes position compensation for the X, Y, and rotation directions. When the measurement object (the circle) rotates, rotation direction position compensation can be executed from the angle formed by a line joining a position on the circumference of the circle with defects, to the center of the circle (and the original rotation model). Defect positions when the rotation region was set will be the reference position. Set the conditions for detecting a mark on the circumference as the defect position.

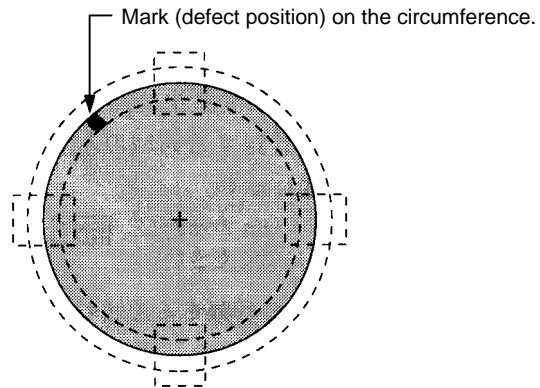

Item	Details
0.Scratch color	Selects the color of the mark for detecting chips and scratches. Select the color of the gray image.
1.Mask size	Set the size of this mask. Set from 4 to 80. Set the mask size according to the size of the mark. The larger the mask size, the slower the processing speed.  The mask is moved a little within the region drawn on the circumference to detect defect positions (mark).
2.Mask pitch	Sets the pitch for moving the mask. Set from 1 to 6. Set the mask size according to the size of the mark. There is no relationship between the mask pitch and processing speed.

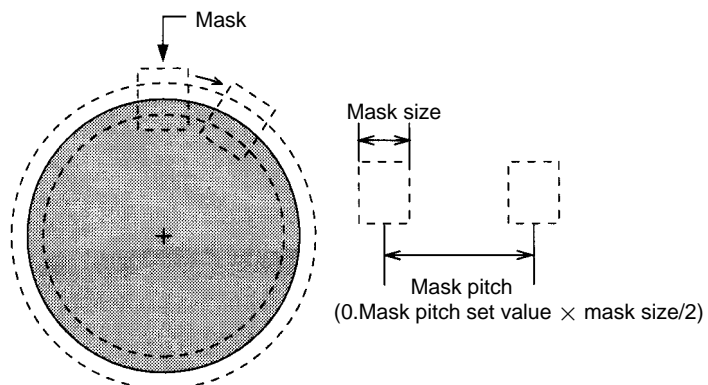

The rotation parameters are indicated below.

Position compensation mode	Rotation parameters
Defect rotation (circle)	All angles
Defect rotation (arc)	From the first point to the last point of the arc.

Procedure

- 1, 2, 3... 1. Select "R.Registration."
- 2. Select "C.Circle positioning."

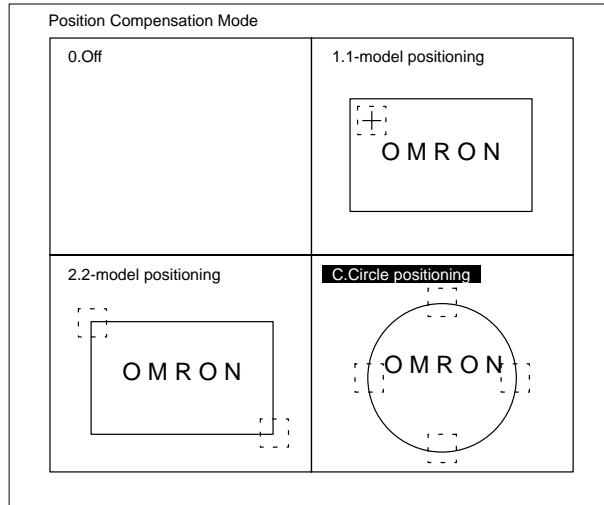

- 3. Select "2.Defect rotation (Circle/Arc)." When the position compensation mode needs to be changed, carry out steps 4 and 5. When the mode is already set on "2.Defect rotation (Circle/Arc)" go to step 6.

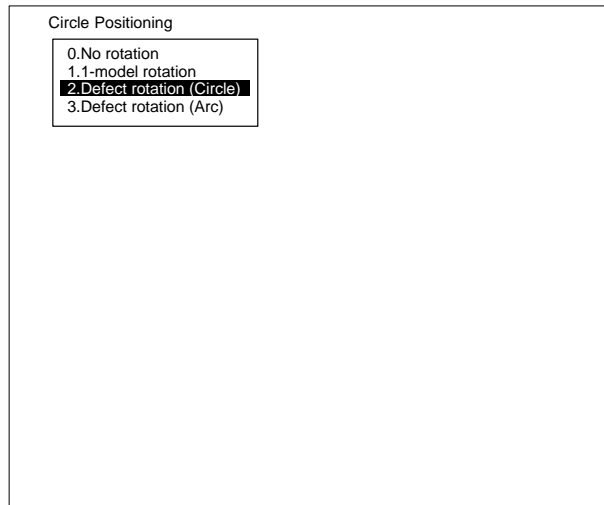

4. Select "X.Execute."

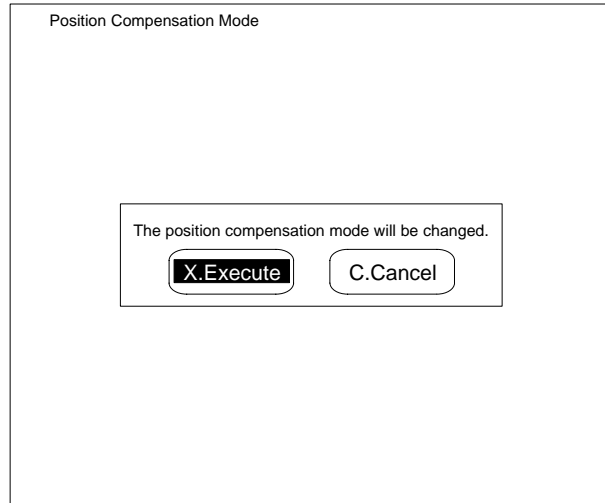

5. Set the position compensation settings. Set "1.Auto-registration" to "No." Set "0.Search verification" to "Required" or "Not required."

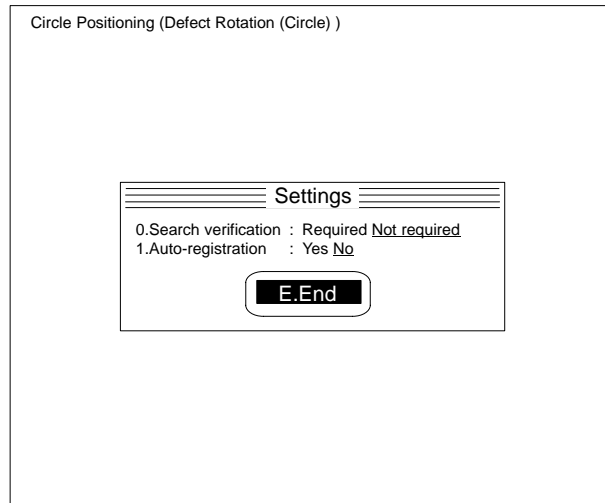

6. Specify the center of the circle by moving the cross cursor and pressing the Enter Key.

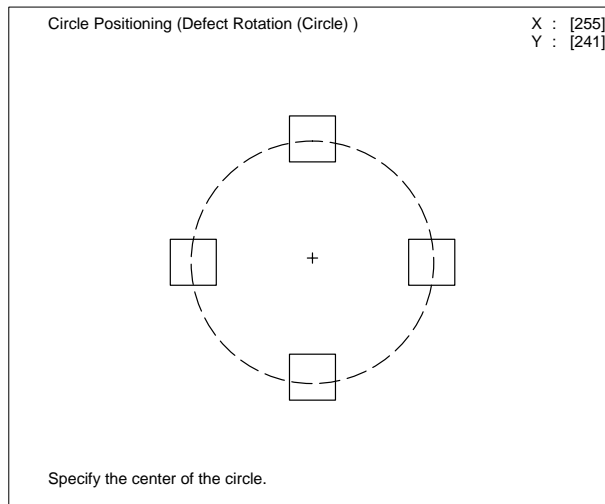

- 7. Specify the radius of the circle by moving the arrow cursor and pressing the Enter Key.

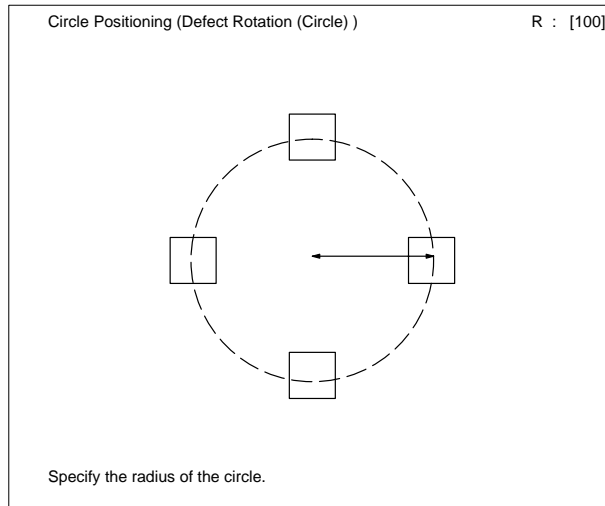

- 8. Specify the size of the model. Only model 0 will be displayed in the dotted box. When the arrow cursor is moved, the size of models 0 to 3 will be changed. Press the Enter Key.

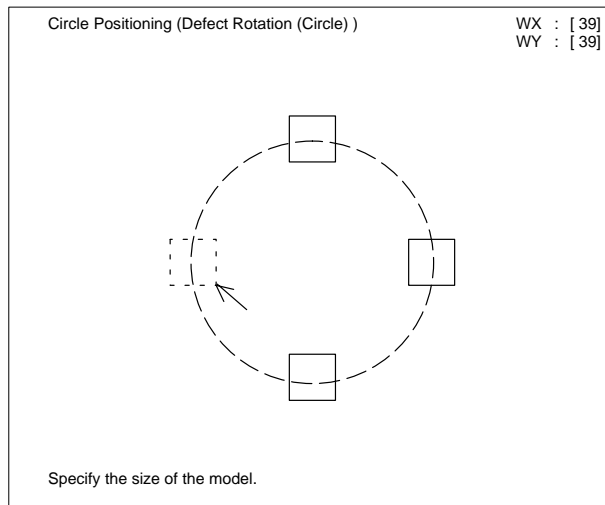

- 9. Specify the line width and radius of the circumference to be set as the rotation model. Move the arrow cursor and press the Enter Key. When "3.Defect

rotation (arc)" is selected, carry out step 10. When "2.Defect rotation (circle)" is selected, go to step 11.

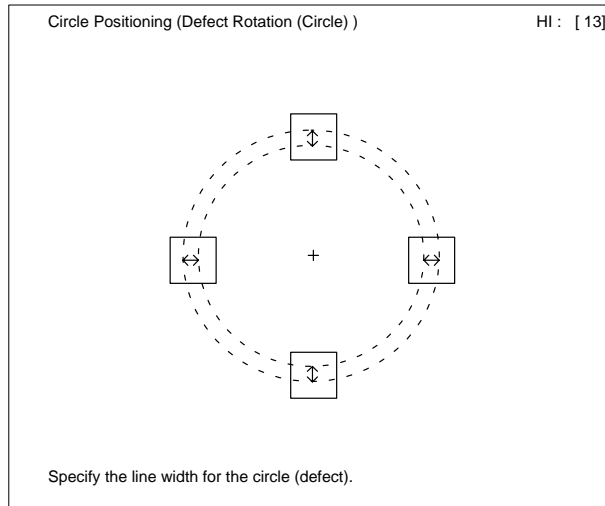

10. Specify the start point and end point of the arc. Move the arrow cursor and press the Enter Key.

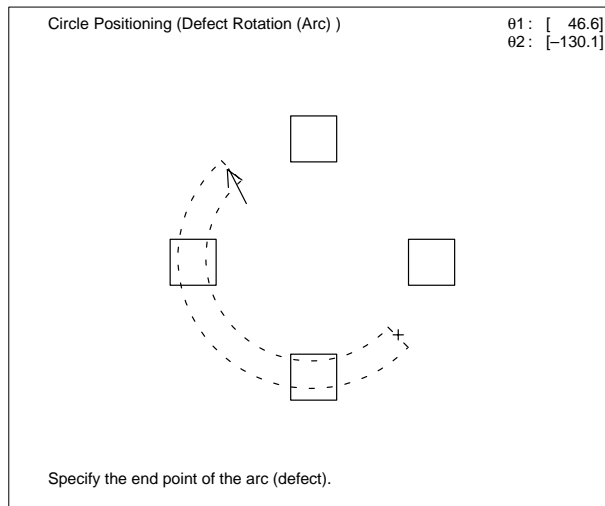

11. Set the conditions for detecting the mark on the circumference as a chip or scratch.

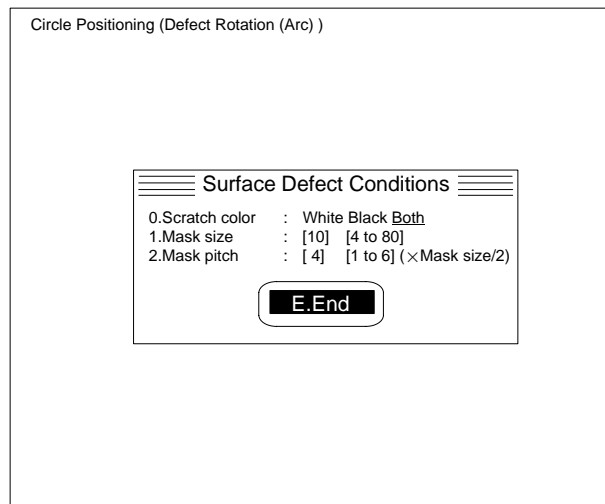

- Press the Enter Key. The image in the specified region will be registered as the model. A cross cursor will be displayed in the defect position of the rotation region, and this will be registered as the reference position.

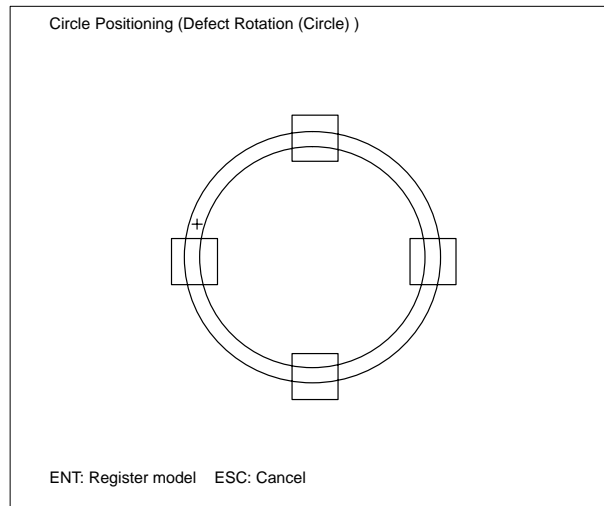

### 4-7-2 Selecting the Rotation Compensation Parameters: T.Rotation Angle

“T.Rotation angle” is used to set the corresponding rotation angle when the rotation of the measurement object is not consistent. The position models registered in “P.Position compensation/R.Registration” are each rotated by the pitch angle inside this parameter and registered. When the measurement object is rotated further than the “T.Rotation angle,” position compensation will not be possible.

**Example**

Rotation angle: All angles

Pitch angle: 30°

Position compensation model

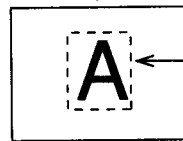

The rectangular region to be registered as the rotation model is automatically cut.

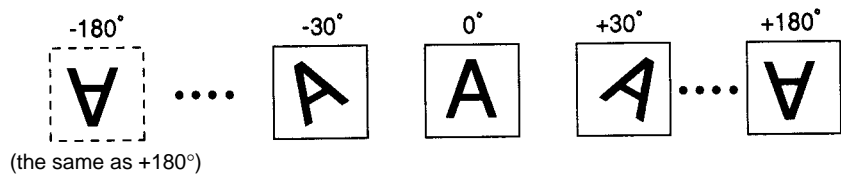

With a rotation angle of “all angles” and a pitch angle of 30°, 12 models that have been rotated by 30° each are registered as rotation models. Rotation models are searched for in the search regions and the image is scrolled by the rotation angle of the model with the highest correlation value. After position compensation according to the rotation model, slight adjustment is made according to the position compensation model.

**Registering Models Automatically**

Automatically register models using the following procedure.

- 1, 2, 3... 1. Register a provisional model.  
Either automatic or manual registration can be used.
2. Set the rotation angle and pitch angle of the rotation model.
3. Execute automatic model registration once the model is in the correct position.

If the rotation angle and pitch angle of the rotation model are changed after auto-registration, measurement will be incorrect.

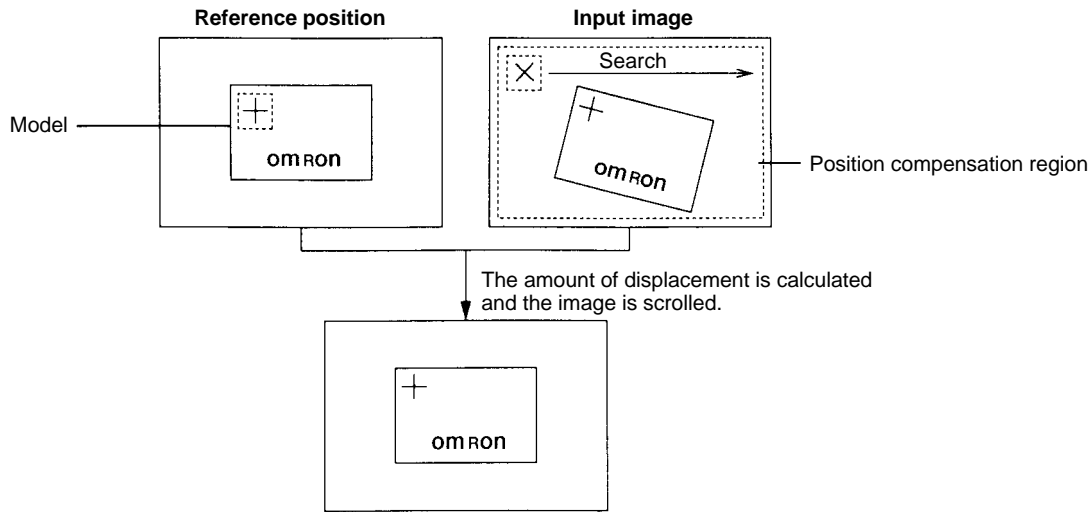

Processing time based on set data can be monitored on the video monitor. Refer to 4-8 M.Measure/O.Measure monitor and 4-9-1 Entering Measurement Screens.

**Procedure**

- 1, 2, 3... 1. Select "T.Rotation angle." To make changes to the set pitch angle, carry out steps 2 and 3. When there are no changes, go to step 4.

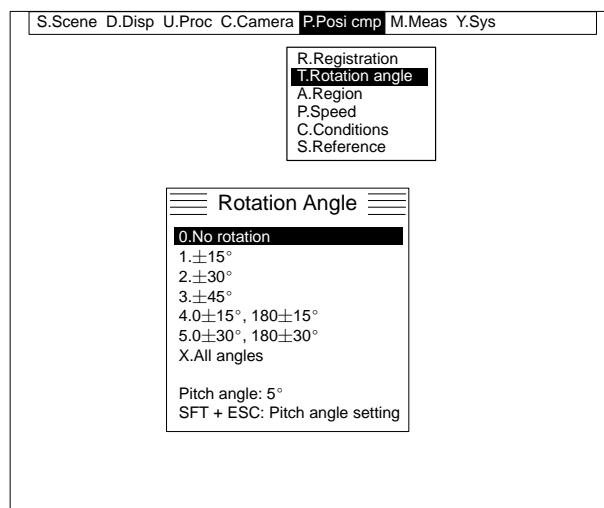

2. Press the Shift+Escape Keys. The pitch angle setting screen will be displayed.

3. Select the pitch angle.

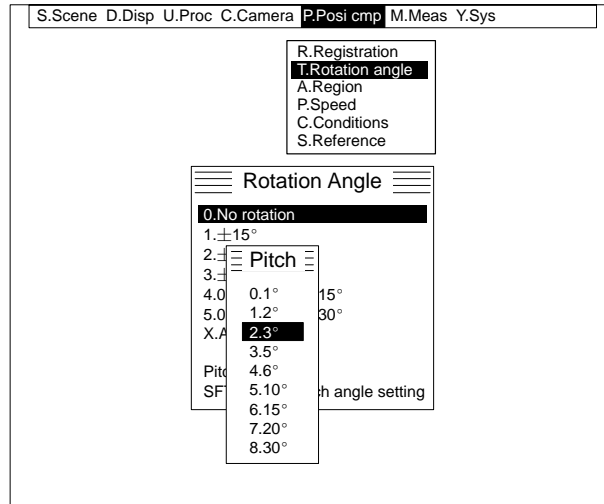

4. Select the rotation angle.

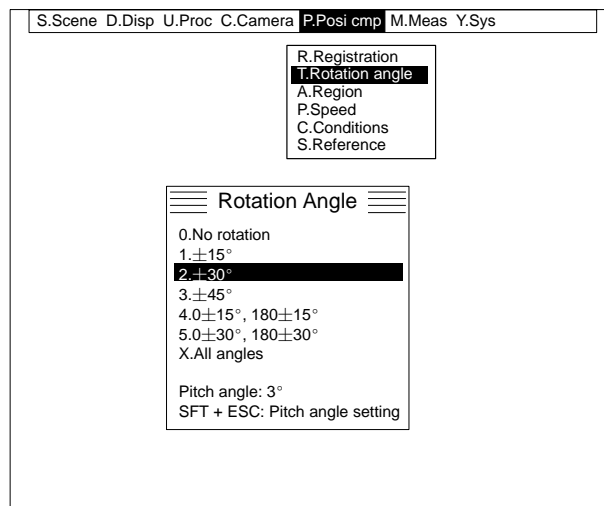

### 4-7-3 Setting the Position Compensation Region: A.Region

“A.Region” sets the region for searching for the position compensation models. When setting either “2-model positioning” or “C.Circle positioning” under “P.Position compensation/R.Registration,” set the position compensation region for models 0 onwards in sequence. Set the region so that position compensation models can be found even if the measurement object moves. Correct position compensation cannot be executed if position compensation models cannot be found in the position compensation region.

#### Procedure

- 1, 2, 3... 1. Select “A.Region.” The position compensation region will be displayed in the dotted line frame. The region registered as the position compensation model will be displayed in the solid line frame.
2. Specify the top-left coordinates of the position compensation region. Move the arrow cursor and press the Enter Key.



- Specify the bottom-right coordinates of the position compensation region. Move the arrow cursor and press the Enter Key. When registering several models, repeat steps 2 and 3.

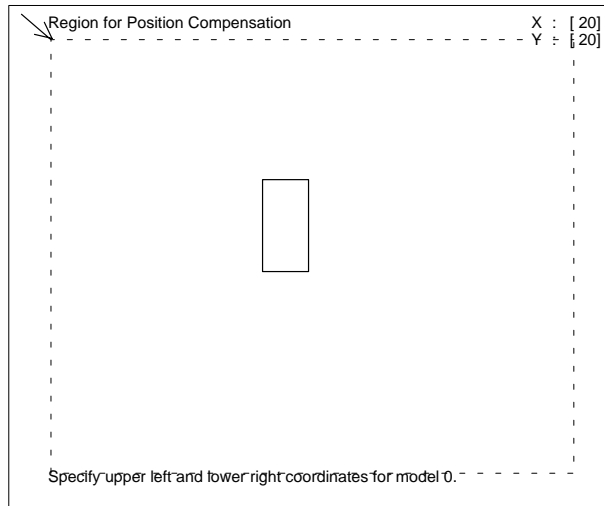

- Press the Enter Key. The specified region will be registered as the position compensation region.

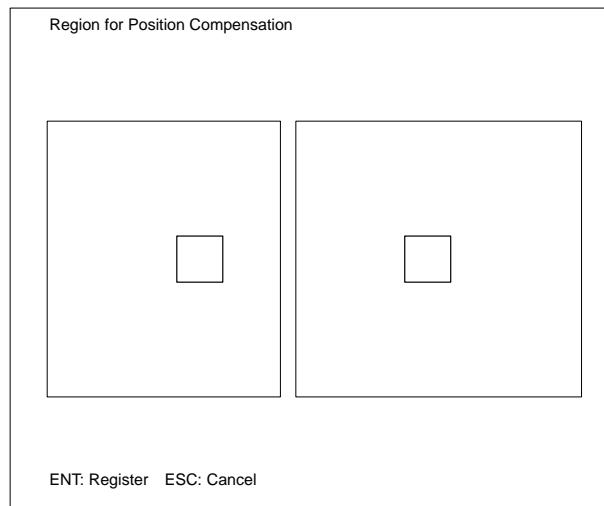

### 4-7-4 Selecting the Position Compensation Speed: P.Speed

“P.Speed” selects the speed at which position compensation is executed. The position compensation processing speed is set for the currently displayed process number. The processing speed of position compensation set for other process numbers cannot be changed.

Position compensation speed	Details
Normal	Executes position compensation for the image within the frame (33 ms 512×484). The processing speed varies according to factors such as the position compensation mode, the rotation parameters, the pitch angle, and whether search verification is needed.
Fast	Executes position compensation for the image within the field (16.7 ms 512×242). The processing speed varies according to factors such as, the position compensation mode, the rotation parameters, the pitch angle, and whether search verification is needed. If there is no affect on positioning even if vertical resolution is halved, then select “fast” to reduce the time required for measurements. For the F300-A20R Shutter Camera I/F Unit and the F300-A20RS/A22RS Single Shutter Simultaneously Camera I/F Unit, only the fast speed can be selected.

Processing time based on set data can be monitored on the Video Monitor. Refer to 4-8 M.Measure/O.Measure Monitor and 4-9-1 Entering Measurement Screens.

### Procedure

- 1, 2, 3... 1. Select "P.Speed."  
2. Select the speed.  
3. Select "E.End."

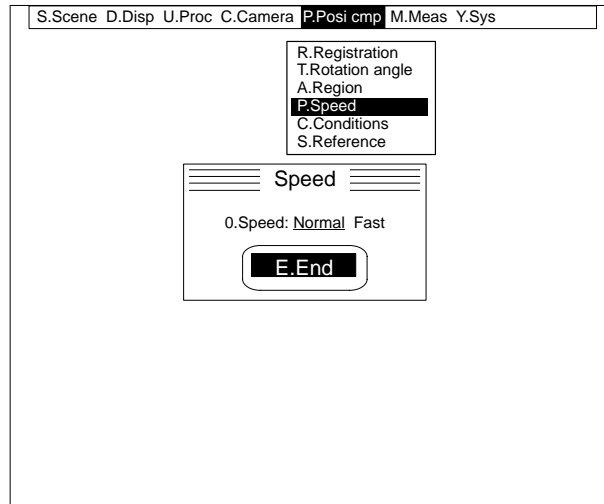

### 4-7-5 Selecting the Position Compensation Conditions: C.Conditions

The conditions set here are used to judge OK/NG for the correlation values of position compensation models found in the position compensation region. Set the "judgement flag" to "ON" for position compensation judgements to be made during measurement. Set the search correlation value to 100 for images which match the models exactly.

In the following situations, set the "1.Search correlation" value regardless of whether the "O.Judgement flag" is set.

- **Registering a Position Compensation Model Automatically**  
Set the "1.Search correlation" before executing automatic registration for the model. The F350 uses this setting to cut the appropriate position compensation region.
- **"Search Verification" Set to "Required" in the Settings Mode**  
The F350 detects as candidates areas with correlation values greater than the search correlation values.

Procedure

- 1, 2, 3... 1. Select "C.Condition."
2. Sets the conditions for position compensation.

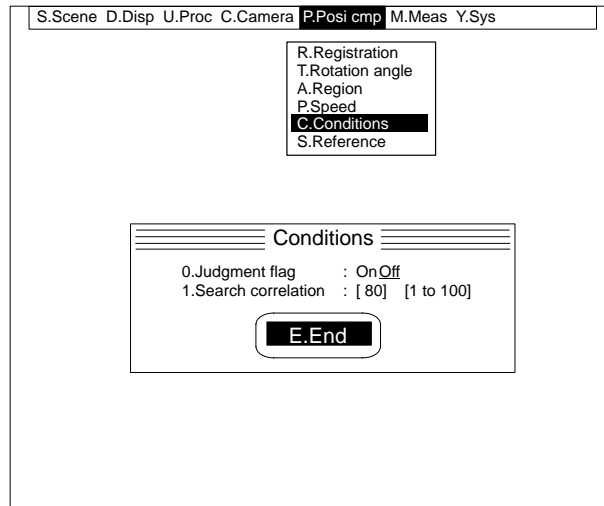

### 4-7-6 Checking the Set Data: S.Reference

"S.Reference" can be used to display and monitor data set under position compensation. Data cannot be changed.

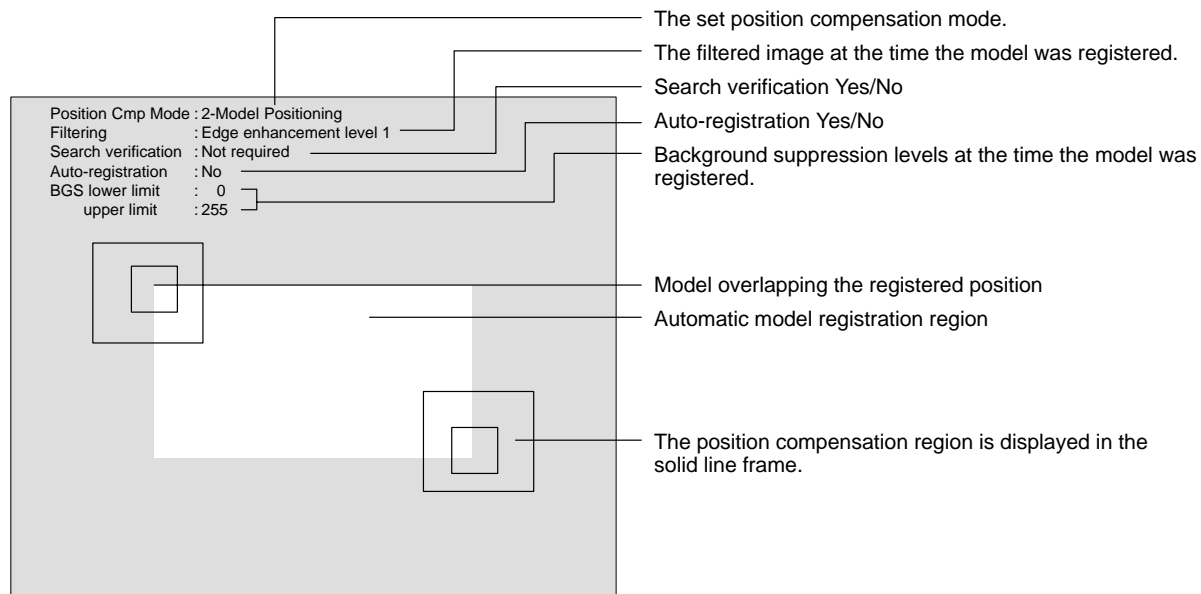

The accuracy of position compensation can be monitored by using the following procedure.

1. Select "D.Display/P.Input image after position compensation" and input the image. Refer to 4-2-3 Inputting Images After Position Compensation.
2. Select "P.Position compensation/S.Reference."

## 4-8 M.Measure/O.Measure Monitor

“M.Measure/O.Measure Monitor” can be used to monitor measurement values and times before performing actual measurements.

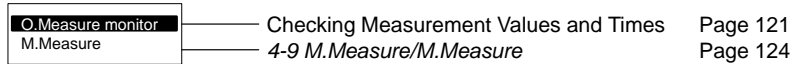

### 4-8-1 Checking Measurement Values and Times: O.Measure Monitor

“O.Measure monitor” monitors measurement values based on the set data. Measured results are output to the Video Monitor only, even when a Parallel I/O Unit, or Terminal Block Unit is mounted. The measurement time for each process is also displayed on the Video Monitor. When several processes are set, the measurement time for each can be monitored by switching between them.

**Important**

**Instruction Input Timing**

The next instruction cannot be input while an instruction is being executed. Neither the instruction currently being executed nor the next instruction will be properly executed. When a Terminal Block Unit or Parallel I/O Unit is mounted, the

BUSY signal will turn ON during instruction execution. Check to be sure that the BUSY signal is OFF before inputting the next instruction.

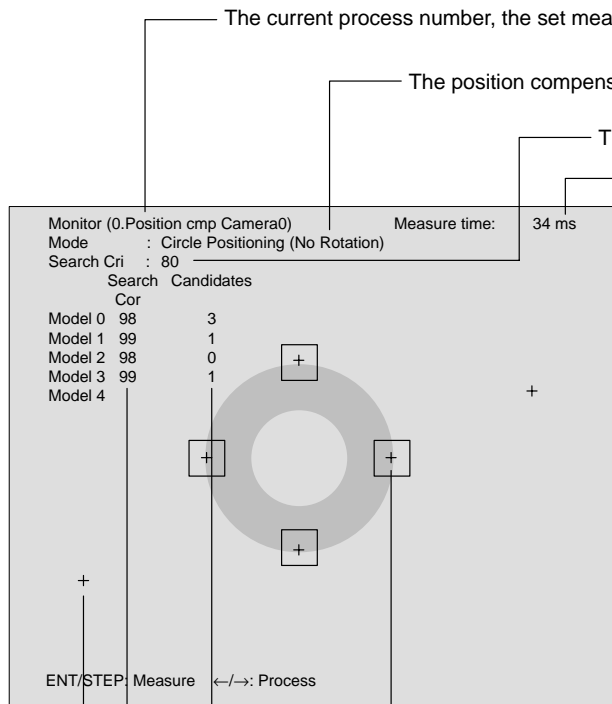

When position compensation is set for the same camera number for the preceding process, the time displayed includes position compensation time.

When position compensation is set in succession, the time displayed includes the time for position compensation over several stages. This does not include the time for displaying the measured results on the Video Monitor.

In some cases, successive processes are processed in parallel. This means that the total of all separate process times will not necessarily equal the scene measurement time. Confirm the measurement time for each scene on the measurement screen.

Refer to 4-9-1 Entering Measurement Screens.

Without search verification:  
The model frame and cross cursor are displayed at the position that has the highest correlation with the search model.

With search verification:  
The model frame and cross cursor are displayed at the position that has the highest correlation with the verification model.

Without search verification: "0" is always displayed.

With search verification:  
Positions for which the correlation with the search model is greater than or equal to the criteria are displayed as the candidate points.

The correlation with the position compensation model is displayed. If the measured value is less than the criteria, NG is determined. In that case, "NG" is displayed here in reverse video.

Without search verification:  
The correlation value of the position that has the highest correlation with the search model is displayed.

With search verification:  
The correlation value of the position that has the highest correlation with the verification model is displayed.

When search verification is required, the cross cursor is displayed at the search candidate point.

### Console

The following instructions can be input from the Console.

Instruction	Key	Action
Measure	ENT	Executes position compensation. When position compensation is set for the same camera number for the preceding process, (or position compensation is set in succession), position compensation is executed over several stages.
Switch process	◀ / ▶	Switches the process and executes the measurement items as set. Processes with no data set are skipped over. When position compensation is set for the same camera number for the preceding process, position compensation is executed over several stages.
Quit measurement	ESC	Quits the measure monitor screen.

### RS-232C

The following instructions can be input via RS-232C. Attach a delimiter to the input code (ASCII). Ensure that it matches the communications specifications of the F350 and the external device.

Refer to 5-2-3 Setting RS-232C Communications Specifications in the F350 Setup Menu Operation Manual.

**Important** Set the instruction delimiter to CR, or CR + LF. Always use channel 0. Channel 1 on the RS-232C Unit cannot be used.

**Measure**

M	Delimiter
m	

Executes position compensation once. When position compensation is set for the same camera number for the preceding process, position compensation is executed over several stages.

**Quit Measurement**

Q	Delimiter
q	

Quits the measure monitor screen.

**Parallel I/O**

The following instruction can be input from a Parallel I/O Unit or Terminal Block Unit. Connect and wire the external devices. The leading edge (OFF to ON) of the STEP signal is indicated by ↓.

Refer to 2-4 Connecting Peripheral Devices in the Setup Menu Operation Manual.

Instruction	Input data STEP DI: 76543210	Action
Measure	↓	Executes position compensation once in sync with the STEP signal's leading edge (OFF to ON). When position compensation is set for the same camera number for the preceding process, (or position compensation is set in succession), position compensation is executed over several stages.

# Measurements

## 4-9 M.Measure/M.Measure

“M.Measure” performs measurement based on the conditions that have been set.

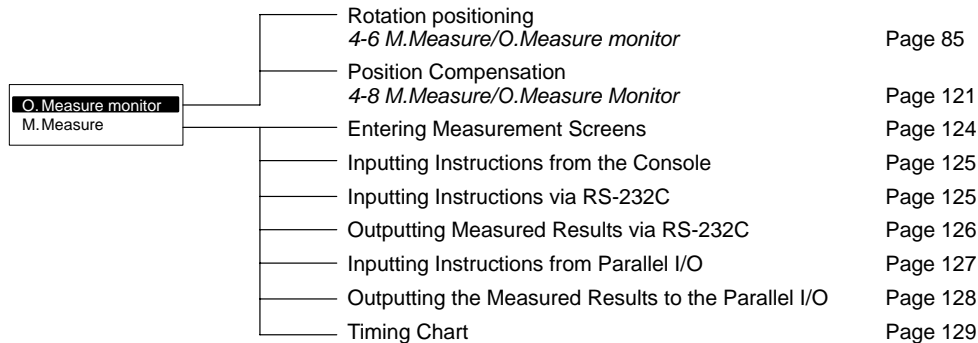

### 4-9-1 Entering Measurement Screens

Measurement is executed on the measurement screen according to instructions. Measurement results are output to the Video Monitor and RS-232C I/F Unit or Parallel I/O Unit. A scene is judged OK only if all the judgement results of processes are OK. When there is one or more NG in the judgement results of the process, the scene’s measured results will be NG.

**Important** When using an F350-C12E IMP Unit, it is necessary to insert a scene data backup Memory Card in order to use multiple scenes. Insert the Memory Card before selecting “M.Measure/M.Measure.”

When an error occurs at the F350 during a measurement, the IMP Unit’s ERROR indicator lights and the ERR signal turns ON. The type of error, however, cannot be distinguished. The appropriate countermeasure depends on the instruction that was input.

The ERR signal remains ON until the measurement screen is quit. You must quit the measurement screen to turn off the error output. Refer to *Section 5 Troubleshooting*.

The measurement object’s process numbers are displayed in reverse video.

The scene’s judgement results.

Measure (Scn 0) Overall Judgment: <b>OK</b>		Measure time: 550 ms	
0.		8	
1.	Rotation (Cam0): <b>OK</b>	9	
2.	Rotation (Cam0): <b>OK</b>	A.	
3.		B.	
4.		C.	
5.		D.	
6.		E.	
7.		F.	
2model X Y θ			
0	0.252	0.006	0.1144
1	0.367	0.018	0.1563
2	62.878	-70.854	36.9857
3	0.387	0.036	0.2022

ENT/STEP: Measure SFT + ↓/↑: Switch scn ESC: Quit

The measurement time of the currently displayed scene.

The measurement items and camera numbers that are set.

When the external output device specified in “P.Rotation positioning/O.Output conditions” is not mounted, the two-model pairings measured values will be displayed.

The measurement screen can be displayed at startup so that instructions can be input immediately. Refer to 4-10-1 Automatic Measurements.

### 4-9-2 Inputting Instructions from the Console

**All Measurement Items**

The following commands can be input from the Console.

Instruction	Key	Action
Measure	ENT	Executes the measurement.
Switch scene	SHIFT + ▲/▼	Increments or decrements the currently displayed scene number.
Quit measure	ESC	Quits the measurement screen.

### 4-9-3 Inputting Instructions via RS-232C

The following instructions can be input via RS-232C. Attach a delimiter to the input ASCII code. Ensure that it matches the communications specifications of the F350 and the external device.

Refer to 5-2-3 Setting RS-232C Communications Specifications in the Setup Manual.

**Important** Set the instruction delimiter to CR, or CR + LF. Always use channel 0. Channel 1 on the RS-232C I/F Unit cannot be used.

**All Measurement Items**

**Measure**

M m	Delimiter	Executes one measurement.
--------	-----------	---------------------------

**Switch Scene**

S s	Scene No.	Delimiter	Switches to the specified scene number.
--------	-----------	-----------	---

**Switch Camera**

C c	Process number	Delimiter	Switches to the camera for the specified process number.
--------	----------------	-----------	--

**Specify Process**

U u	Beginning process number	,	Ending process number	Delimiter	Set so that the measurement items for only the specified processes are measured.
--------	--------------------------	---	-----------------------	-----------	--

**Load Scene Data**

OF of	Filename (no extension)	Delimiter	Loads scene data from the specified file on the Memory Card to the currently displayed scene number.
----------	-------------------------	-----------	--

**Quit Measure**

Q q	Delimiter	Quits the measurement screen.
--------	-----------	-------------------------------

**Position Compensation**

**Automatic Register**

R r	Process number	Delimiter	When automatic registration is specified, the region most suitable for position compensation is cut from the automatic registration region and re-registered as the position compensation model.
--------	----------------	-----------	--



Rotation Positioning

Automatic Register

R	Process number	Delimiter
---	----------------	-----------

The most appropriate region for the measurement model is automatically cut from the model automatic registration region and registered again as a measurement model.

### 4-9-4 Outputting Measured Results via RS-232C

The following data format is output the process number and the model number in sequence beginning with the most recent one via RS-232C. Data is output in ASCII. The measured results for two-model pairings are output after measurement is complete for all the processes set in rotation positioning. Match the communications specifications to F350 and the external devices.

Refer to 5-2-3 *Setting RS-232C Communications Specification: R.RS-232C* in the *Setup Menu Operation Manual*.

**Important** Set the instruction delimiter to CR, or CR + LF. Always use channel 0. Channel 1 on the RS-232C Unit cannot be used.

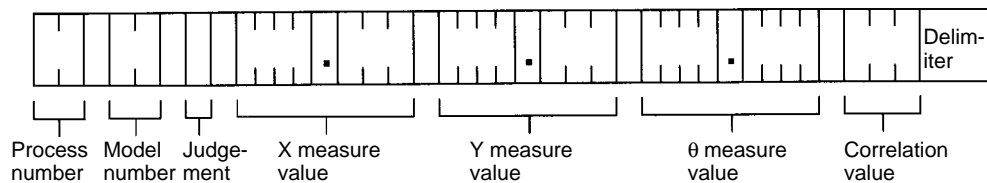

Spaces are output in areas which contain no numbers.

Output item	Contents
Process number	Outputs the process number (00 to 15).
Model number	Outputs the model number (00 to 07). When it is set to two-model pairings, the setting number + 20 is output. (20 to 27).
Judgement	Outputs the judgement results. (0: OK, 1: NG) When the correlation value is less than the search criteria or the measurement value overflows the display area, a NG result will be output. When the two-model pairing measured results are output, usually 0 (OK) will be output.
X measure value, Y measure value	Outputs the measure value (X and Y displacements): -999.999 to 999.999.
theta measure value	Outputs the measure value (rotation direction displacement): -180 to 180°.
Correlation value	Outputs the correlation value with the model: 000 to 100.

The following response is output when an instruction other than a measurement instruction is input.

When ended normally:

O	K	Delimiter
---	---	-----------

When ended abnormally:

E	R	Delimiter	Input instruction	Delimiter
---	---	-----------	-------------------	-----------

### 4-9-5 Inputting Instructions from Parallel I/O

The commands shown in the following table can be input from a Parallel I/O Unit or a Terminal Block Unit.

ON status of bits is indicated by "1" and OFF status by "0." An asterisk (\*) indicates that either is possible.

Set DI 0 to 6 and then turn on DI 7 1 ms later.

The leading edge (OFF to ON) of the STEP signal is indicated by ↓. Connect and wire the external devices.

Refer to 2-4 *Connecting Peripheral Devices* in the *Setup Manual*.

#### All Measurement Items

Instruction	Input data								Action	
	STEP	DI: 7	6	5	4	3	2	1		0
Measure	↓									Executes a single measurement in sync with the STEP signal's leading edge (OFF to ON).
			1	0	0	1	*	*	*	*
Switch scene	(Example:)		1	0	1	0				Switches scene for measurement. This example switches to scene 2.
Switch camera	(Example:)		1	0	1	1				Switches to the camera for the specified process number. This example switches to the camera set for process 3.
			1	0	1	0	0	0	1	
Specify beginning process number			1	1	0	1				Set so that measurements are executed from the specified process number through process #15 (or the ending process number). If a number greater than the ending process number is specified, then the ending process number will be changed to the same number as the beginning process number.  This setting is valid only for the scene number that is currently being displayed.
Specify ending process number			1	1	1	0				Set so that measurements are executed from process #0 (or the beginning process number) through the specified process number. If a number smaller than the beginning process number is specified, then the beginning process number will be changed to the same number as the ending process number.  This setting is valid only for the scene number that is currently being displayed.

#### Position Compensation

Instruction	Input data								Action	
	STEP	DI: 7	6	5	4	3	2	1		0
Automatic registration			1	1	0	0				When automatic registration is specified, the region most suitable for position compensation is cut from the automatic registration region and re-registered as the position compensation model.

#### Rotation Positioning

Instruction	Input data								Action	
	STEP	DI: 7	6	5	4	3	2	1		0
Automatic registration			1	1	0	0				The most appropriate region for the measurement model is automatically cut from the model automatic registration region and registered again as a measurement model.

### 4-9-6 Outputting the Measured Results to the Parallel I/O

The measured results are output in sequence for the process number and the model number from the most recent ones. The measured results for two-model pairings are output after measurement is complete for all the processes set in rotation positioning. Last, the judgement results for processes are output. The measurement values are output in the following order: X direction displacement, Y direction displacement, and rotational direction displacement. All are output as 32-bit binary data.

Set the output specifications on the setup menu. Refer to 5-2-4 *Setting the Output Specifications for Parallel Data* in the *Setup Menu Operation Manual*. Connect and wire external devices. Refer to 2-4 *Connecting Peripheral Devices* in the *Setup Menu Operation Manual*.

When measured results exceed the number of output bits (23-bit binary data, bits 0 to 22), the excess bits are cut and discarded.

#### Measured Results for Rotation Positioning

DO	Output details
0 to 22	X and Y direction displacements are output. The measured results for X and Y direction displacements are multiplied by 1000 and output. The rotation direction displacement results is multiplied by 10000 and output.
23	Outputs the judgement results. (0: OK, 1: NG). When the correlation values less than the search criteria or the measurement value overflows the display area, a NG result is output.
24 to 26	Outputs the model number. When it is set on the measured results for two-model pairings, the setting number is output.
27	When the model number is output for DO24 to 26, 0 is output. When the setting number for two-model pairing is output for DO 24 to 26, 1 is output.
28 to 31	Outputs the process number. When the measured results for two-model pairings are output, the last process number set for rotation positioning is output.

Example: 32 contact output points, process number 3, model number 5, X direction displacement of -42.315 mm.

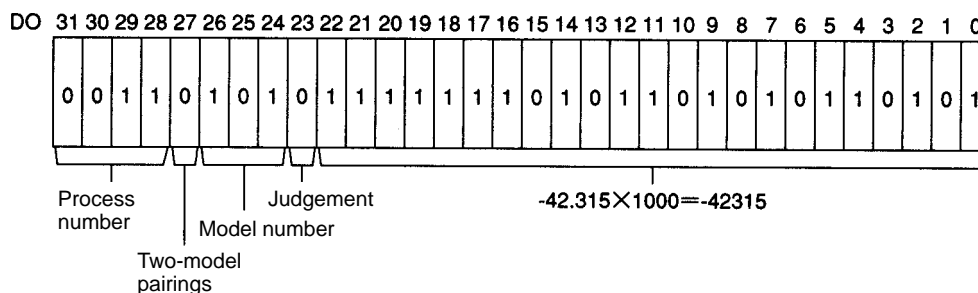

#### Process Judgement Results

DO	Output details
0 to 15	The judgement results for processes 0 to 15 (OFF(0): OK, ON(1): NG).
23	All the judgement results for set processes. All OK: OFF. One or more NG: ON.

### 4-9-7 Timing Charts

The timing for processing using Parallel I/O is illustrated in the following charts.

#### Measurement by STEP Input without Handshaking (Output Device: Parallel I/O)

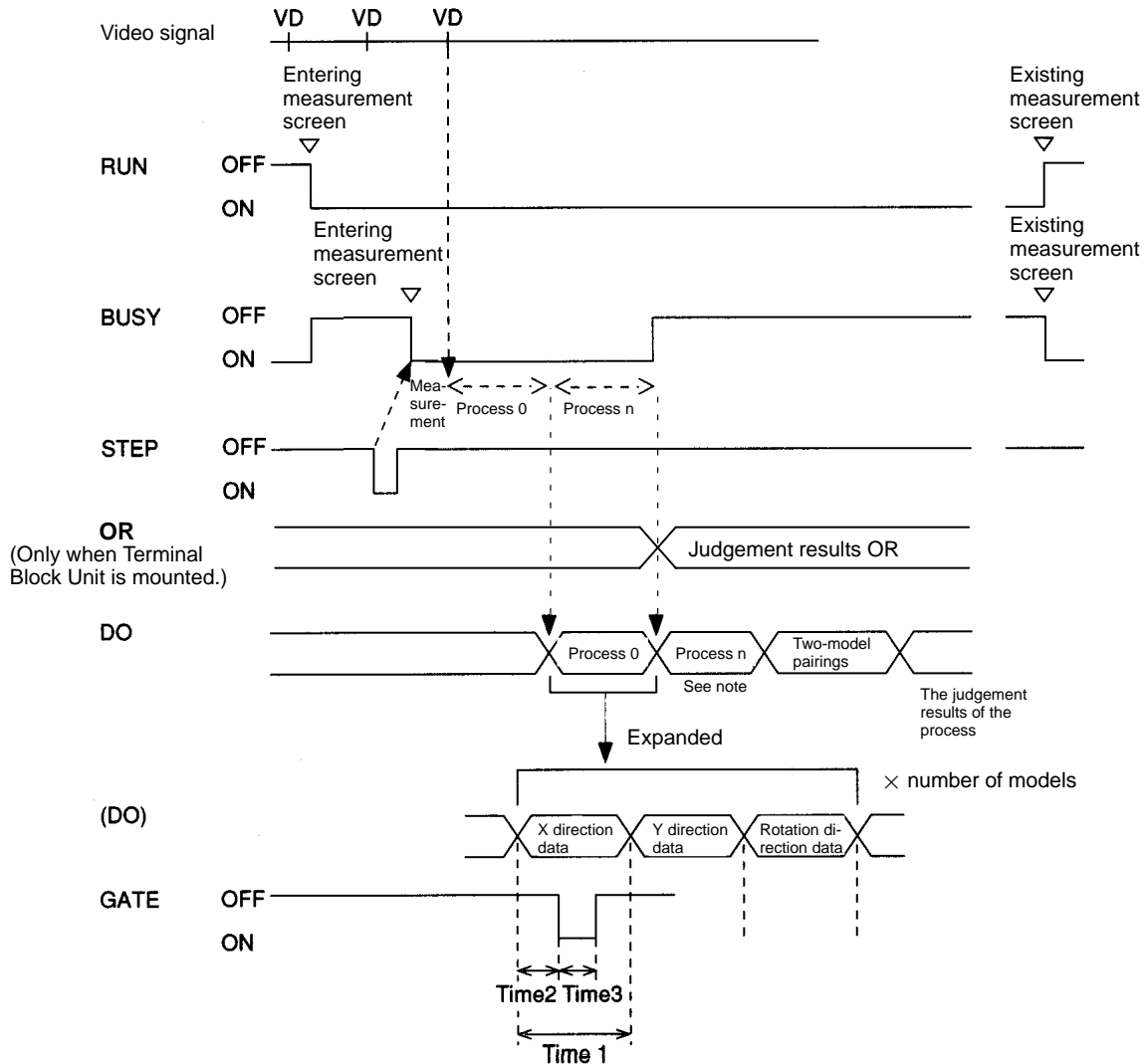

**Note** When the measured results are not being output for each model, the two-model pairings judgement results are output first.

Terminal	Action
RUN	ON while measurement screen is entered.
BUSY	ON while instruction is being processed in the measurement screen. <b>Important</b> Do not input the next instruction while the BUSY signal is ON, or neither the current processing nor the instruction that is input will be properly executed.
STEP	Executes a single measurement in synchronicity with the STEP signal's leading edge (OFF to ON).
OR	When a Terminal Block Unit is mounted, a logical OR of the judgement results for all processes is output to the OR terminal. The OR signal turns ON if even one of the results is NG.
DO	Outputs data.
GATE	Used to control the timing to obtain data. The output period, delay time, and output time are set with the setup menu so that GATE will be ON until the data is obtained. Time1 (C.Output period): Sets the period outputting data. Time2 (D.Delay time): Sets the time from the moment when data is output to the moment when the GATE signal is turned on. Time3 (O.Output time): Sets the time during which the GATE signal is turned on. Refer to 5-2-4 <i>Setting the Output Specifications for Parallel Data: P.I/O Unit</i> in the <i>Setup Menu Operation Manual</i> . Obtain the data while the GATE signal is ON.

Measurement by STEP Input with Handshaking (Output Device: Parallel I/O)

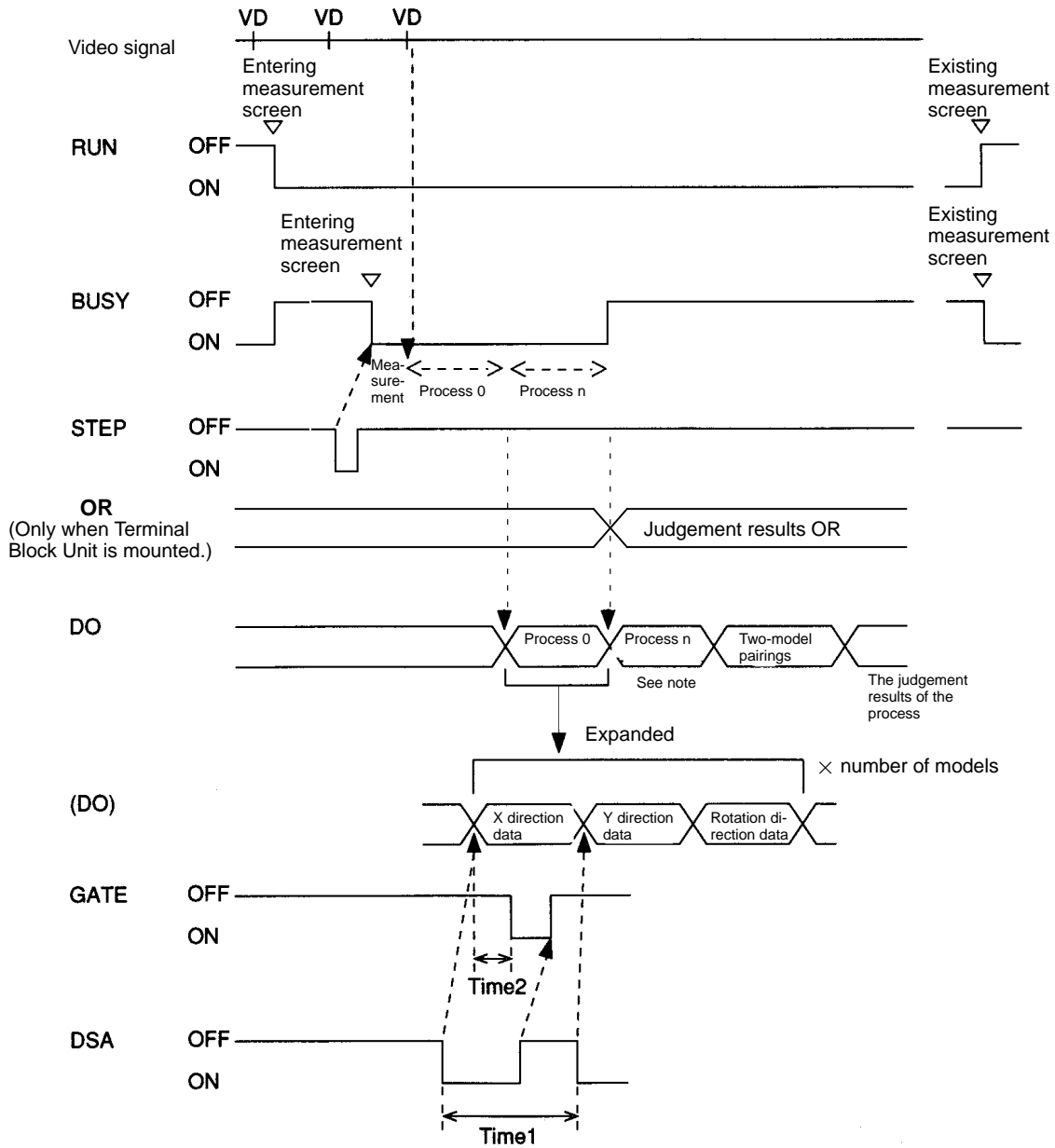

**Note** When the measured results are not being output for each model, the two-model pairings judgement results are output first.

Terminal	Action
RUN	ON while measurement screen is entered.
BUSY	ON while instruction is being processed in the measurement screen. <b>Important</b> Do not input the next instruction while the BUSY signal is ON, or neither the current processing nor the instruction that is input will be properly executed.
STEP	Executes a single measurement in synchronicity with the STEP signal's leading edge (OFF to ON).
OR	When a Terminal Block Unit is mounted, a logical OR of the judgement results for all processes is output to the OR terminal. The OR signal turns ON if even one of the results is NG.
DO	Outputs data.
GATE	Used to control the timing to obtain data. The delay time is set with the setup menu so that they will be ON until the data is obtained. Time2 (D.Delay time): Sets the time from the moment when the data is output to the moment when the GATE signal is turned on. Obtain data while the GATE signal is turned on. Refer to 5-2-4 Setting the Output Specifications for Parallel Data: P.I/O Unit in the Setup Menu Operation Manual.
DSA	Used to request the next data output from the external device. Turn this on when the external device is ready to receive the next data. The F350 does not output data until the DSA signal changes from OFF to ON (i.e., until rise is detected). If the time-out function is set, a time-out error occurs under the following condition. The DSA signal does not change from off to on within the time-out period. Time1: Time-out period Sets the period from the moment when the DSA signal turns on to the moment when the DSA signal turns on again. Refer to 5-2-4 Setting the Output Specifications for Parallel Data: P.I/O Unit in the Setup Menu Operation Manual.

Measurement by STEP Input (Output Device: RS-232C)

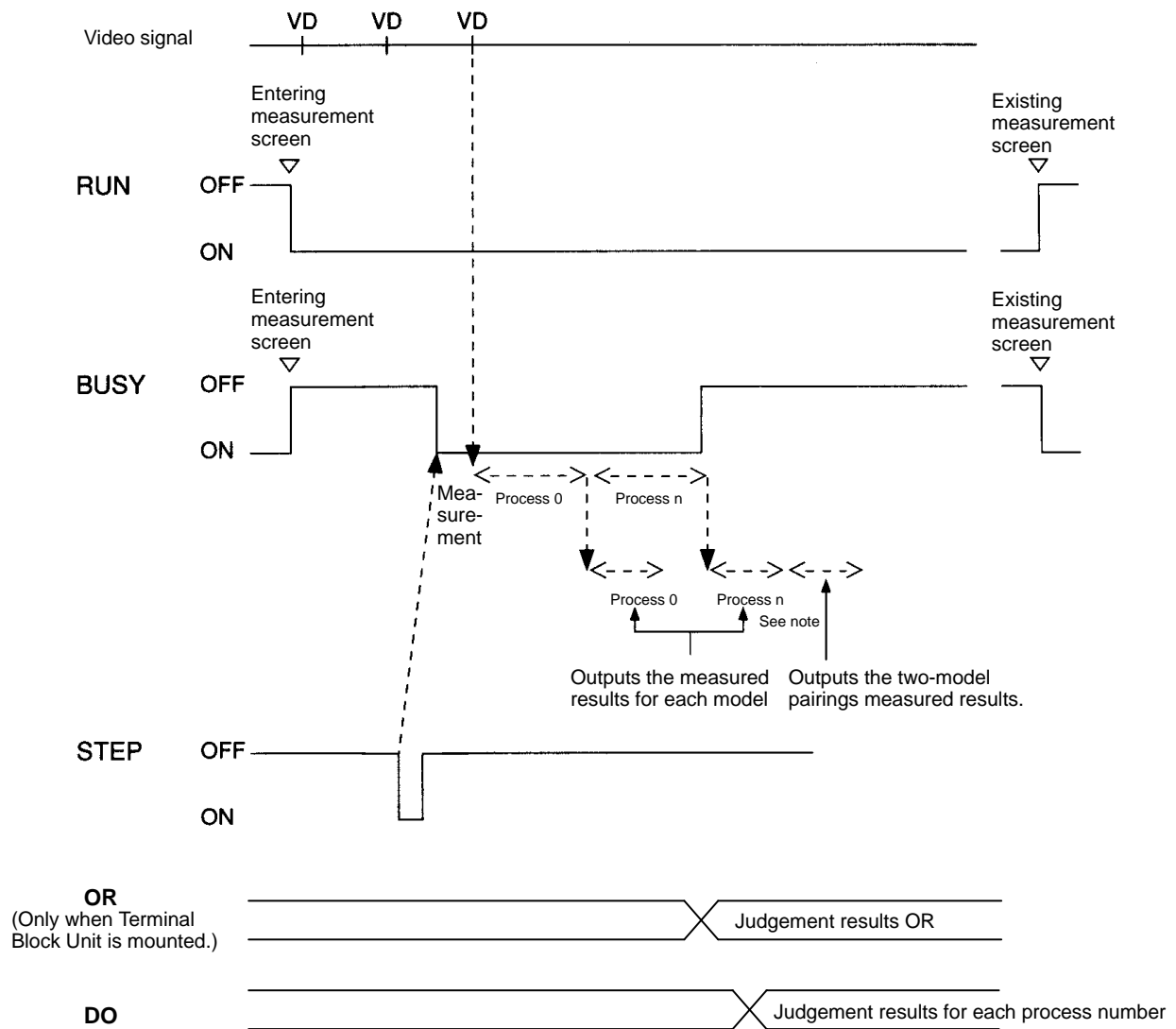

**Note** When the measured results are not being output for each model, the two-model pairings judgement results are output first.

Terminal	Action
RUN	ON while measurement screen is entered.
BUSY	ON while instruction is being processed in the measurement screen. <b>Important</b> Do not input the next instruction while the BUSY signal is ON, or neither the current processing nor the instruction that is input will be properly executed.
STEP	Executes a single measurement in synchronicity with the STEP signal's leading edge (OFF to ON).



Continuous Measurement (Output Device: Parallel I/O)

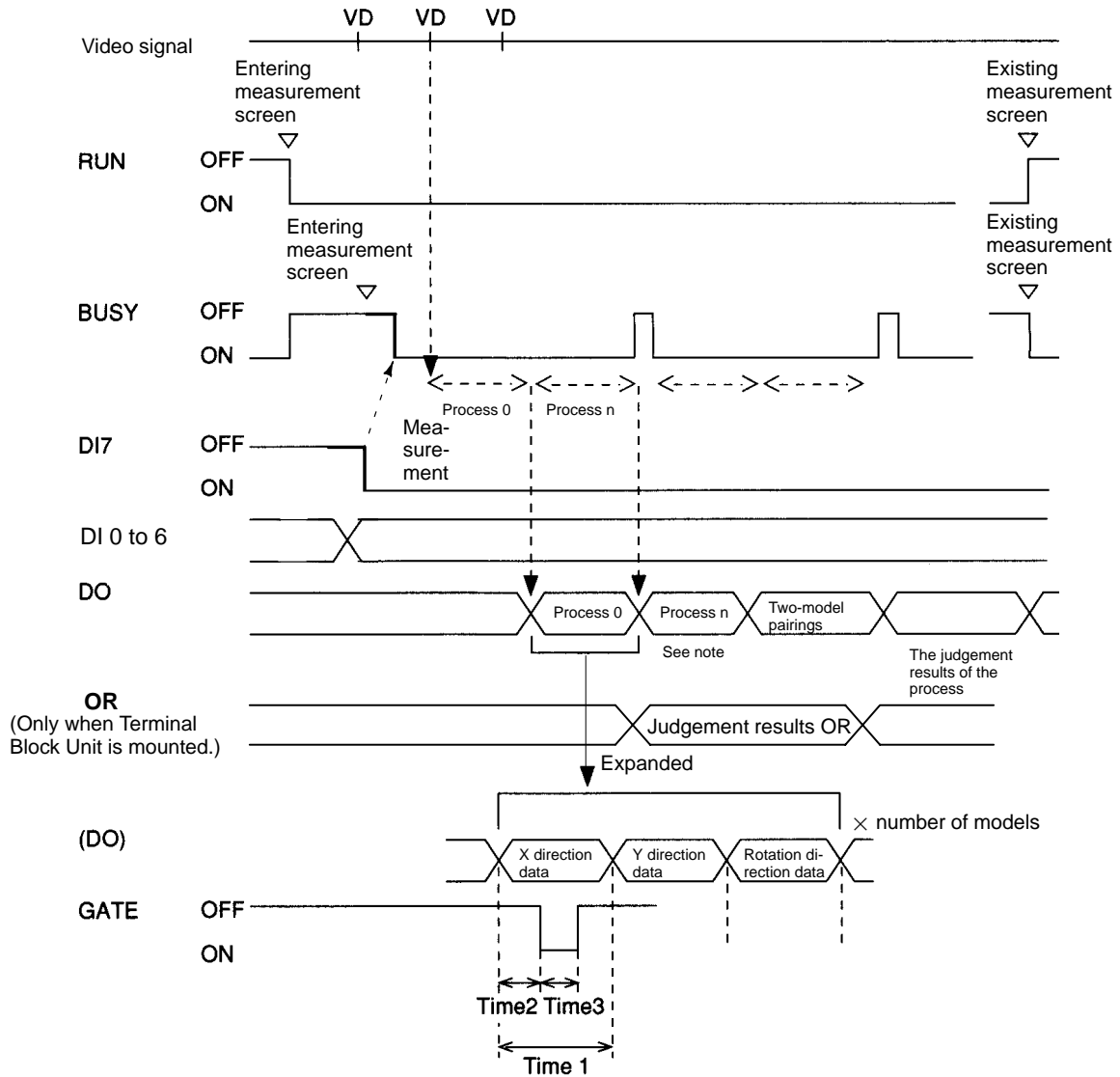

**Note** When the measured results are not being output for each model, the two-model pairings judgement results are output first.

Terminal	Action
RUN	ON while measurement screen is entered.
BUSY	ON while instruction is being processed in the measurement screen.
DI	Inputs measurement instructions. Set DI0 to DI6, and turn ON DI7 after 1 ms.
OR	When a Terminal Block Unit is mounted, a logical OR of the judgement results for all processes is output to the OR terminal. The OR signal turns ON if even one of the results is NG.
DO	Outputs data.
GATE	Used to control the timing to obtain data. The output period, delay time, and output time are set with the setup menu so that GATE will be ON until the data is obtained. Time1 (C.Output period): Sets the period outputting data. Time2 (D.Delay time): Sets the time from the moment when data is output to the moment when the GATE signal is turned on. Time3 (O.Output time): Sets the time during which the GATE signal is turned on. Refer to 5-2-4 Setting the Output Specifications for Parallel Data: P.I/O Unit in the Setup Menu Operation Manual. Obtain the data while the GATE signal is ON.

**Continuous Measurement (Output Device: RS-232C)**

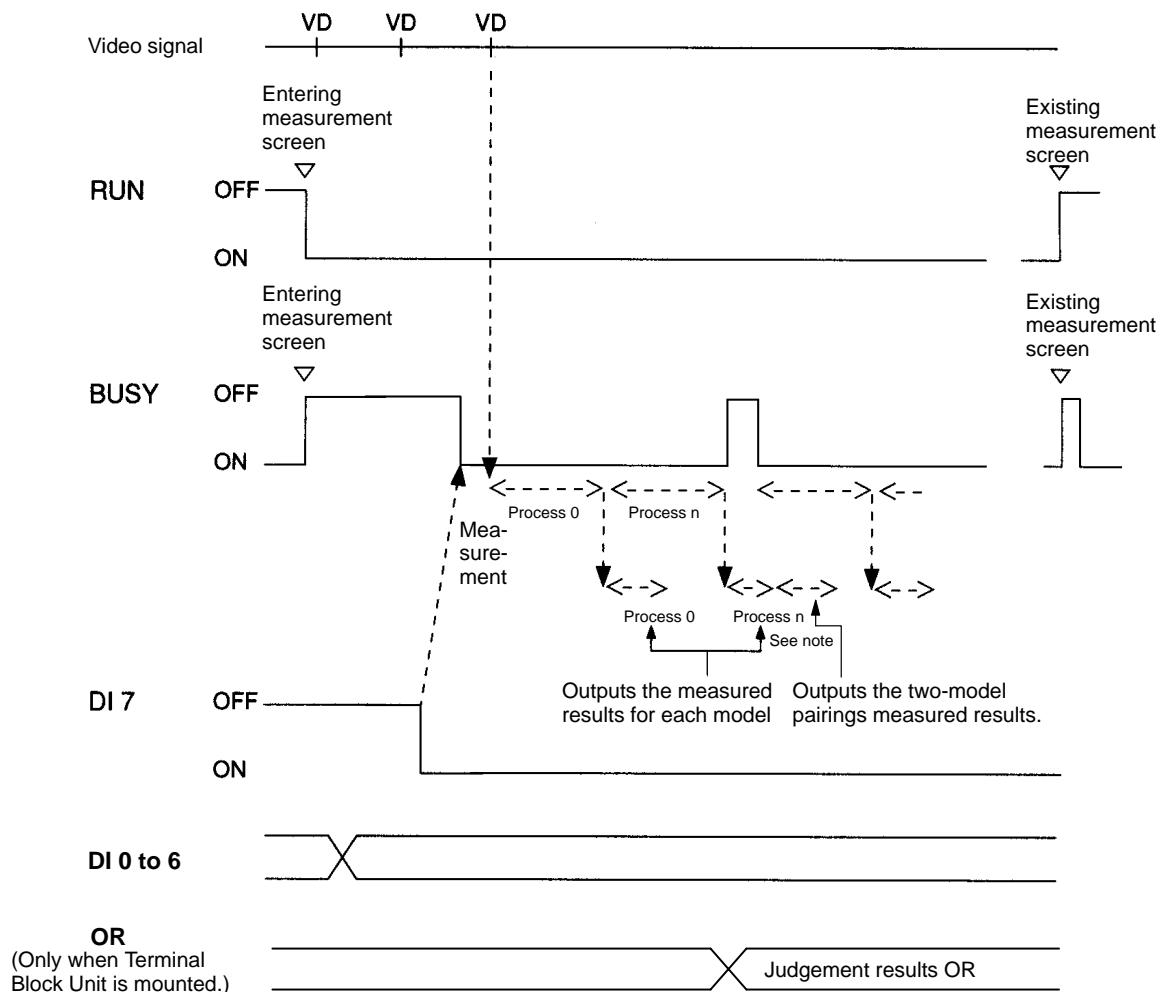

**Note** When the measured results are not being output for each model, the two-model pairings judgement results are output first.

Terminal	Action
RUN	ON while measurement screen is entered.
BUSY	ON while instruction is being processed in the measurement screen. <b>Important</b> Do not input the next instruction while the BUSY signal is ON, or neither the current processing nor the instruction that is input will be properly executed.
DI	Inputs the measurement instruction. Set DI0 to DI6, and turn ON DI7 after 1 ms.

Instructions for Other than Measurements

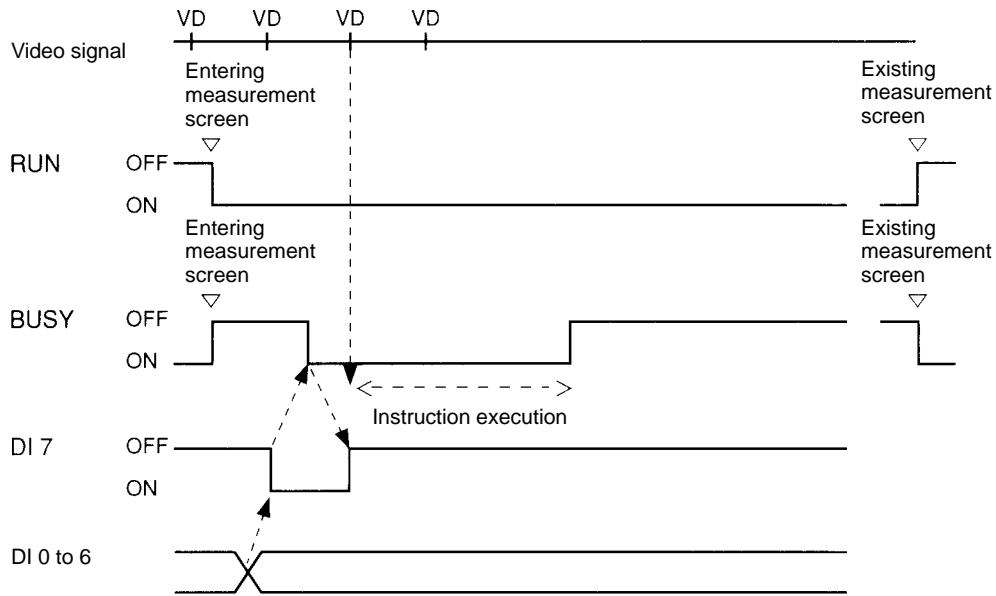

Terminal	Action
RUN	ON while measurement screen is entered.
BUSY	ON while instruction is being processed in the measurement screen. <b>Important</b> Do not input the next instruction while the BUSY signal is ON, or neither the current processing nor the instruction that is input will be properly executed.
DI	Inputs the measurement instruction. Set DI0 to DI6, and turn ON DI7 after 1 ms.

# System

## 4-10 Y.System

“Y.System” saves the set scene data and set the environment data. The data set using “Y.System” does not directly affect the measurement conditions.

M.Initial mode	Automatic Measurement	Page 137
L.Line brightness	Displaying the Line Brightness	Page 138
S.Scene data	Saving and Loading Scene Data	Page 138
O.Model information	Checking Model Registration Conditions	Page 141

### 4-10-1 Automatic Measurement: M.Initial Mode

“M.Initial mode” is used to display the measurement screen automatically at startup. Measurements will be started as soon as measurement instructions are input. Use “M.Initial mode” for actual operation after all measurement conditions (i.e. all scene data) have been set.

#### Procedure

- 1, 2, 3...**
1. Select “M.Initial mode.”
  2. Set “A.Automatic execution” ON.
  3. Set the scene number in “S.Scene.” The measurement screen for the specified screen number will be automatically displayed the next time the system is started.

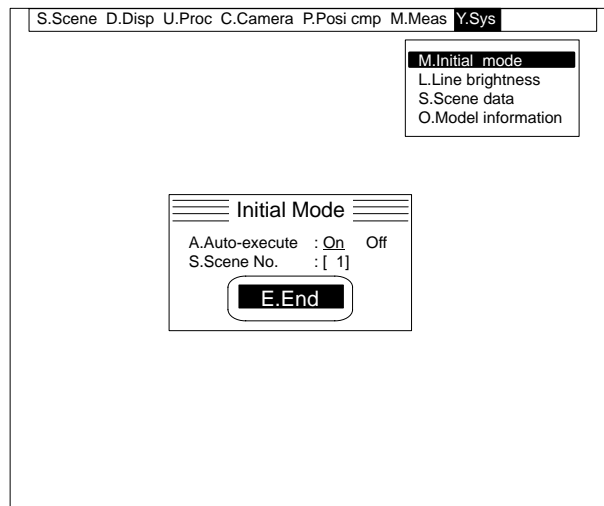

4. Select “E.End.”

### 4-10-2 Displaying the Line Brightness: L.Line Brightness

Line brightness is the name given to a graph which indicates the brightness distribution along a line through the image. The line brightness can be displayed for any arbitrary vertical or horizontal lines through the image.

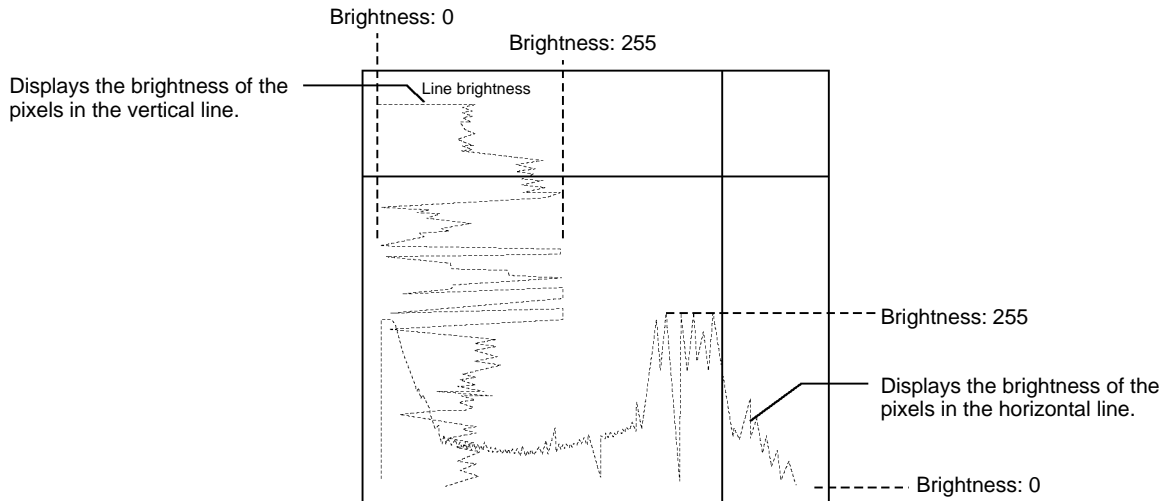

#### Procedure

- 1, 2, 3... 1. Select "L.Line brightness."  
Dotted lines are displayed vertically and horizontally through the cursor. A static (freeze) image is displayed when "L.Line brightness" is selected. If "D.Display/F.Freeze" is set to "U.Unfreeze," display the required image before selecting "L.Line brightness."

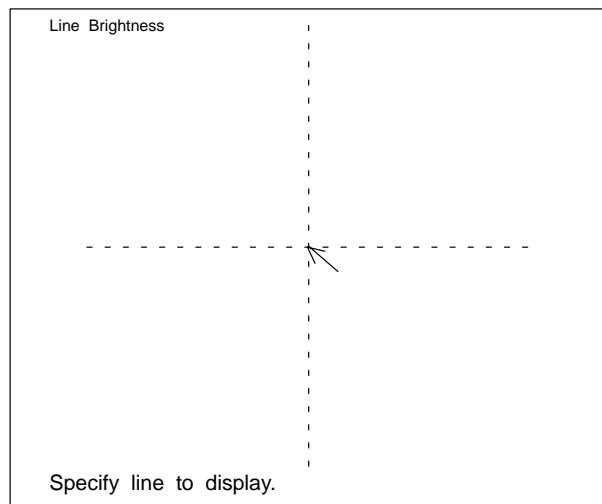

2. Select the line. Move the cursor to the line and press the Enter Key. The line brightness will be displayed for the selected vertical and horizontal lines.
3. Press the Enter Key or the Escape Key to return to the menu.

### 4-10-3 Saving and Loading Scene Data: S.Scene Data

"S.Scene data" loads and saves data to and from the Memory Card. The "Y.System/M.Initial mode" setting does not include scene data. The scene data contents differ depending on the menu.

#### Saving Scene Data

"S.Scene data/S.Save" saves scene data to a Memory Card. The extension ".SCN/.MDL/.VAR" is automatically appended to the saved file name.

When using a new Memory Card for the first time, initialize it using the Setup Menu. Refer to 5-4-1 *Initializing Memory Cards* in the *F350 Setup Menu Operation Manual*.

**Important** When an F350-C12E IMP Unit is used, a Memory Card is required in order to use multiple scenes. Use a separate Memory Card for saving scene data.

Use Memory Cards with enough space available for the data that is set. Standard sizes for scene data are provided in *Appendix B*.

## Procedure

- 1, 2, 3...**
1. Select "S.Scene data."
  2. Select "S.Save."
  3. Input the save destination file name for "N.FileName."

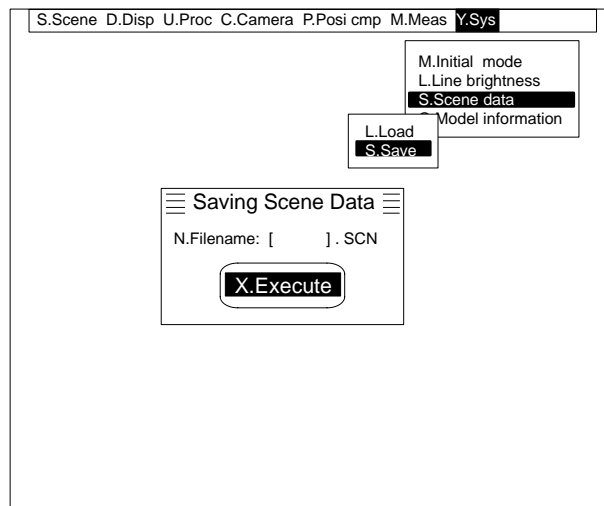

4. Select "X.Execute." The data from the specified scene number will be saved in the memory card under the specified file name.

**Important** Do not turn the power off while data is being saved, or the data will not be saved correctly.

## Loading Scene Data

"S.Scene data/L.Load" loads saved scene data from a Memory Card. Insert a Memory Card containing the saved scene data. When the scene data is loaded, it overwrites the scene data for the currently displayed scene number. Display the load destination scene number before loading.

## Procedure

- 1, 2, 3... 1. Select "S.Scene data."  
 2. Select "L.Load." A list of the scene data file names in the root directory will be displayed. The names of any existing sub-directories will also be displayed.

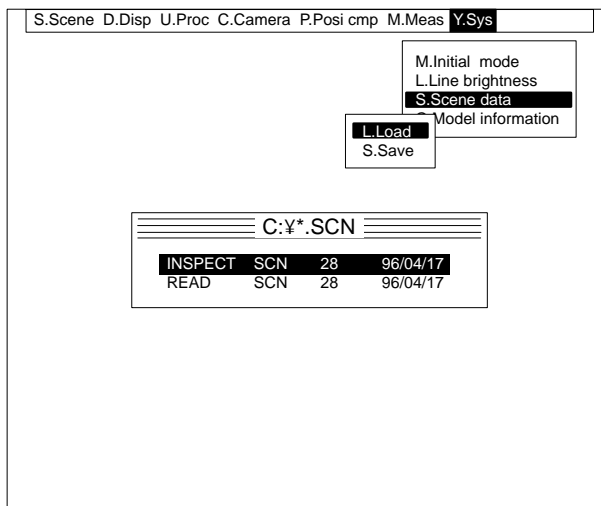

3. Select the file name. A confirmation message will be displayed.

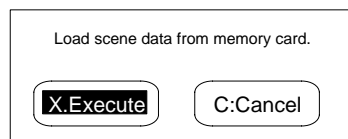

4. Select "X.Execute." The selected scene data will be loaded to the currently displayed scene number.

**Important** Do not turn off the power while loading data. If power is turned off while loading data, memory contents will be destroyed and the F350 will malfunction when it is turned on again.

### 4-10-4 Checking Model Registration Conditions: O.Model Information

O.Model information displays model registration conditions. It can be used to check the number of models that are registered and the number of remaining models that can be registered.

The number of search models registered and the remaining number that can be registered.

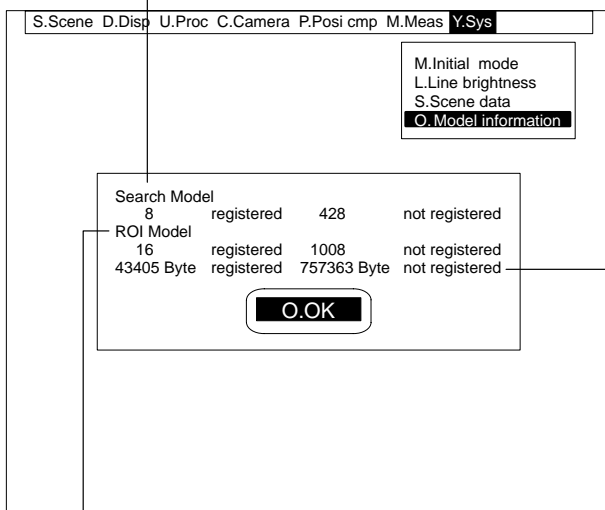

The contents and available space of ROI models can be checked.

The number of ROI models registered and the remaining number that can be registered.

#### Procedure

- 1, 2, 3... 1. Select "O.Model information." The model information will be displayed.
2. Select "O.OK."



## **SECTION 5**

# **Troubleshooting**

This section provides a list of error messages, and the causes and probable remedies for the errors that they indicate.

Errors and the error messages for IC package inspection are listed here in alphabetical order, along with the probable remedied for the errors which the indicate. Refer to this table when explanations of errors are needed.

**ERR Signal ON**

Error	Cause and remedy
Correlation value error	The measurement object does not exist or an image different to the measure model is being viewed. View the correct measure model.
Insufficient results storage area error	Measurement results cannot be properly obtained because of insufficient storage space. Either raise the search level and reduce the number of search candidate points, or reduce the number of models by deleting any not being used for measurements (including those set for other process numbers).
Model auto-registration error	No more models can be registered, because there are too many models or there is insufficient space in the model registration region. Delete any models that are not being used for measurement (including those set for other process numbers). The models are not changed. Any previously registered models are saved.
	Models cannot be cut because the image is either completely black or completely white and is unsuitable for registration as a model. Take images that can be cut as models.
	The position compensation mode is OFF. Models cannot be registered.
	The models are not changed. Any previously registered models are saved.
	The position compensation mode is set for circle positioning. Models cannot be auto-registered in this mode. The models are not changed. Any previously registered models are saved.
Overflow	The measurement values have overflowed the available number of digits. Data will be output as 32-bit data between an upper limit of 7FFFFFFF and a lower limit of 80000000.
Scene data load error	The Memory Card is not correctly inserted. Insert the Memory Card correctly.
	There is no scene data saved on the Memory Card. Insert the Memory Card on which the scene data is saved.
	No more models can be registered, because there are too many models or there is insufficient space in the model registration region. Delete any models that are not being used for measurement.
Scene switching error	The Memory Card is not correctly inserted. Insert the Memory Card correctly.
	The scene data is not backed up on a Memory Card. Insert a Memory Card for backing up the scene data.
	No more models can be registered, because there are too many models or there is insufficient space in the model registration region. Delete any models that are not being used for measurement.
Timeout error	A timeout error occurred while data was being output to a Parallel I/O Unit or a Terminal Block Unit. Quit the measurement screen and check the external connections and output specifications.

**Error Messages**

Error message	Cause and remedy
Automatic registration failed.	Dissimilar models cannot be automatically cut. Either change the region or use manual cutting.
Calibration failed.	The correlation value between the model and workpiece is less than the correlation criteria. Check if the workpiece is proper or register the model again.
Camera magnification is outside the specified range.	Calibrate so that the camera magnification will be within a range from 0.001 and 9.999 (mm/pixel).
Cannot be registered. No space in model registration region.	No more models can be registered. Either reduce the size of model regions or delete any unnecessary models in the region.
Cannot copy to the same process number.	The process number is the same for the copy source and the copy destination. Specify different process numbers.
Cannot copy to the same scene number.	The scene number is the same for the copy source and the copy destination. Specify different scene numbers.

Error message	Cause and remedy						
Cannot save to Memory Card. Not sufficient space.	The Memory Card does not have enough free space to save to. Insert a Memory Card with sufficient free space and try again.						
Cannot switch scenes due to lack of space in the scene data area.	The currently displayed scene data is too large. Reduce its size by deleting some models or by clearing any unnecessary scene data, and then try again.						
Circle positioning set for position compensation mode. Cannot use auto-registration.	Auto-registration cannot be used for circular workpiece positioning. Either perform registration manually or use 1-model or 2-model positioning.						
Failed to access the scene switching file.	There is no available space on the Memory Card. Either delete any unnecessary scene data, or use the setup menu to delete unnecessary files. Then try again.						
	The file could not be created because the Memory Card was not correctly inserted. Insert the Memory Card correctly, and then try again.						
	The Memory Card is not initialized. Use a Memory Card that has been initialized.						
	The Memory Card is write protected. Clear the write protection and then try again.						
Failed to clear scene.	The scene clearing operation was cancelled because the Memory Card was not correctly inserted. Insert the Memory Card correctly, and then try again.						
Failed to copy scene data due to lack of space in the scene data area. The scene data in the copy destination area will be cleared.	There is no available space in the scene data area. Delete any unnecessary scene data.						
	The scene copying operation was cancelled because the Memory Card was not correctly inserted. Insert the Memory Card correctly, and then try again.						
File does not exist.	There is no scene data file. Insert the Memory Card which contains the scene data.						
Mask size or mask pitch setting is inappropriate.	The mask does not match the size of the rotation positioning region. Either reduce the size of the mask or increase the diameter of the circle (or arc).						
Measurement item is not set.	There is no measurement item set for the currently displayed process number. Set a measurement item. Refer to 4-3-1 <i>Setting Measurement Items</i> .						
Measurement item is not set in the copy source.	There is no data set for the process number specified as the copy source. Specify a process number for which data is set.						
No Memory Card inserted.	The operation is not possible because no memory card is inserted. Insert a memory card and try again.						
No model registered.	Inspection is impossible if no model is registered. Register a model first.						
	A non-registered model number was specified for two-model pairings. Retry after registering the model.						
	Calibration is impossible if no calibration model is registered. Register a calibration model.						
Optimum model was not found.	The region setting for automatic registration is too small, or the image is completely black or completely white. Adjust the region setting or take the optimum image as the model.						
Pitch angle setting is inappropriate.	<p>The following combination of pitch angle and rotation parameters cannot be set.</p> <table border="0" style="margin-left: auto; margin-right: auto;"> <tr> <td style="text-align: center;"><b>Rotation parameters</b></td> <td style="text-align: center;"><b>Pitch angle</b></td> </tr> <tr> <td style="text-align: center;">±15 ° or 0±15°, 180±15°</td> <td style="text-align: center;">20° or 30°</td> </tr> <tr> <td style="text-align: center;">±45 °</td> <td style="text-align: center;">20°</td> </tr> </table>	<b>Rotation parameters</b>	<b>Pitch angle</b>	±15 ° or 0±15°, 180±15°	20° or 30°	±45 °	20°
<b>Rotation parameters</b>	<b>Pitch angle</b>						
±15 ° or 0±15°, 180±15°	20° or 30°						
±45 °	20°						
Position compensation mode is set to circle positioning (no rotation or defect rotation). Rotation angle is invalid.	The rotation angle setting is not required when either circle positioning with no rotation or defect rotation is set for the position compensation mode. Specify this parameter for a position compensation mode for which the rotation parameters are valid is set.						
Scene data is different.	This is not the scene data for the currently installed application program. Insert the memory card that contains the correct scene data.						
Scene data loading cancelled due to an error. Scene data will be cleared.	Loading was cancelled because the memory card was not correctly inserted. Insert the memory card correctly and load the scene data again.						
	The scene data in the subdirectory cannot be loaded. Load the scene data in the root directory.						

Error message	Cause and remedy
Scene data saving cancelled due to an error.	Saving was cancelled because the memory card was not correctly inserted. Insert the memory card correctly and save the scene data again.
	Saving not possible because the memory card is not initialized. Save the scene data again using an initialized memory card.
	The operation cannot be executed because the Memory Card is write protected. Clear the write protection and try the operation again.
Settings required for measurement have not been completed.	Not even one model has been set for the process. Set the models.
The model region is too small.	The model region cannot be specified less than 23×19. Enlarge the model region.
The position compensation mode is turned Off.	Rotation parameters, position compensation region, position compensation speed, conditions, or referencing was executed without the position compensation registration having been performed. First register the position compensation.
Too many graphics. No more can be created.	No more than ten figures can be created for regions for automatic model registration for position compensation. Do not create more than ten figures.
Too many models. No more can be registered.	No more models can be registered. Delete any unnecessary models.
Wrong model image.	The image is completely white or completely black, without features, and is unsuitable for registration as a model. Register a suitable model.

**Error Codes**

Error code	Cause and remedy
23	Line buffer overflow. It is possible that commands were input continuously through the RS-232C port. Check the method for inputting commands.
103	It is possible that commands were incorrectly input through the RS-232C, e.g., without a delimiter. Check the method for inputting commands.

# Appendix A

## Menu Hierarchy Diagrams

### Menu Item Notation

Menu items are sometimes abbreviated on the menu bar due to space limitations. In this manual, the non-abbreviated form of the menu items are used and, if an abbreviation is displayed on the menu bar, the characters that are actually displayed are underlined. If no characters are underlined, then the menu item is not abbreviated on the display.

For example, "O.Position compensation" appears on the menu display as "O.Posi cmp" and is given in this manual as "O.Position compensation."

# Common Items

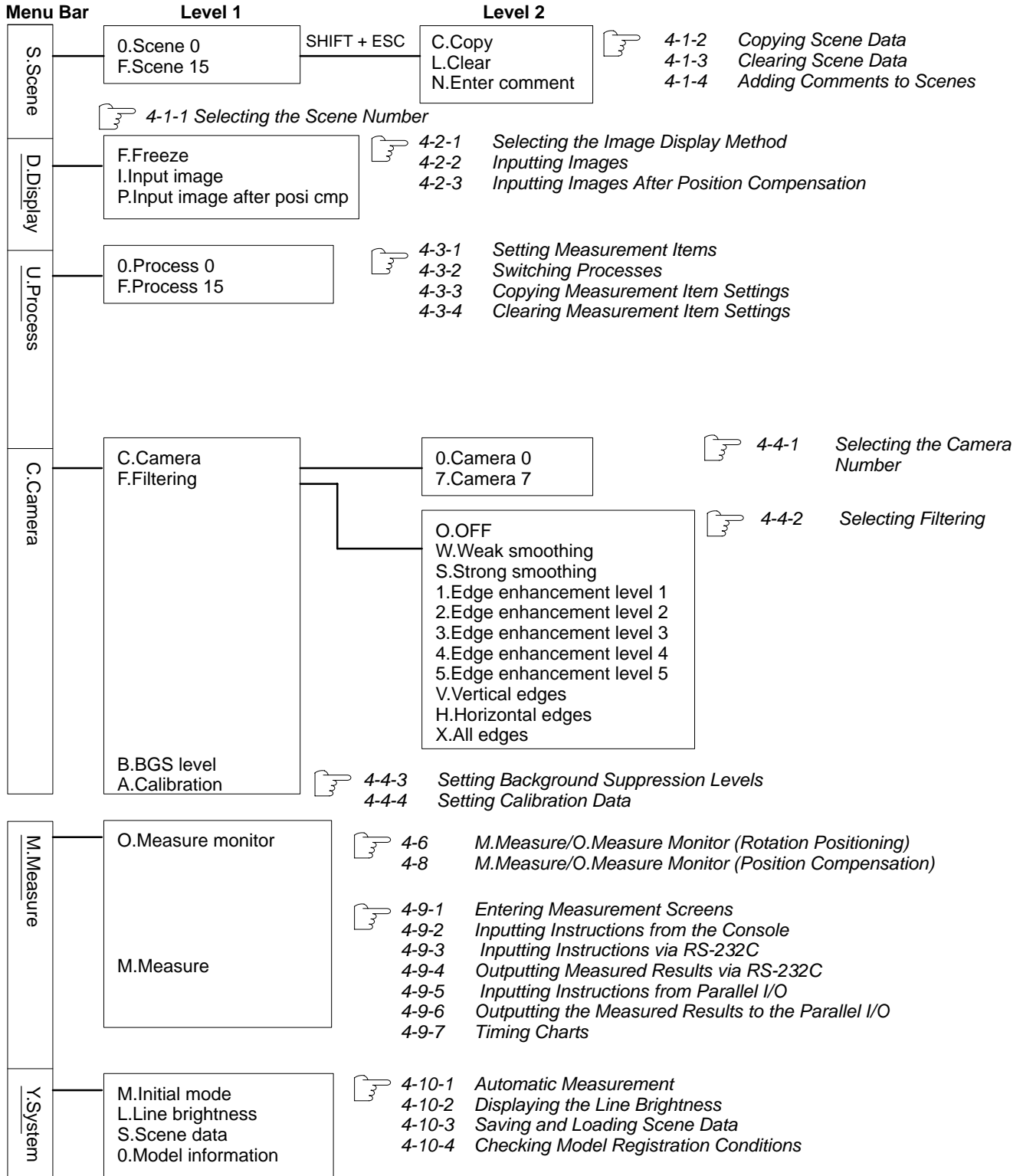

## Rotation Positioning

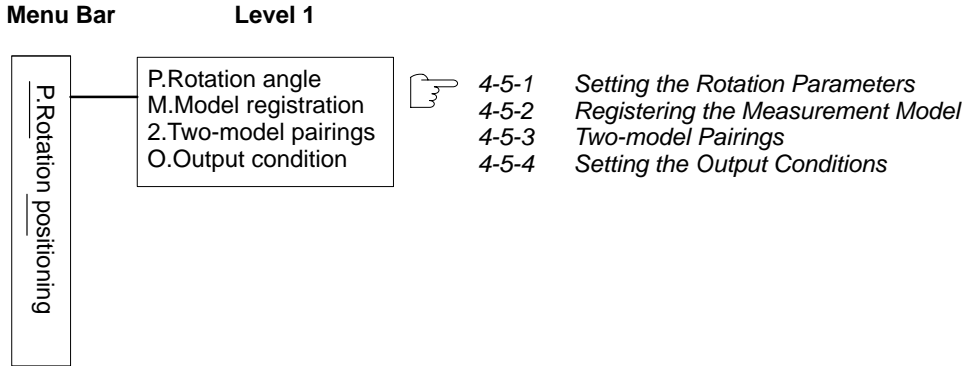

## Position Compensation

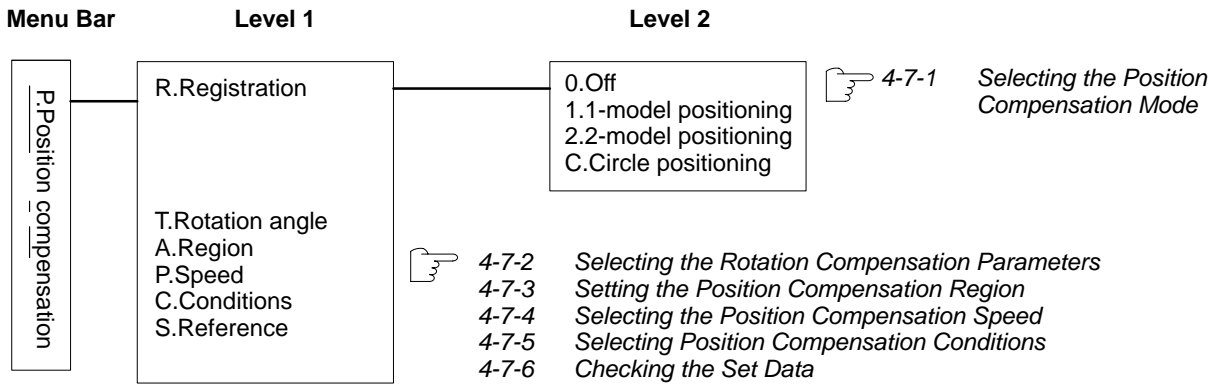

# Appendix B

## Scene Data Size

This appendix shows the formula for finding scene data sizes. Prepare a Memory Card with sufficient capacity for the data. The size found by means of this formula is only a reference. To make a more precise determination of scene data size, it is recommended to actually save the data and then check its size.

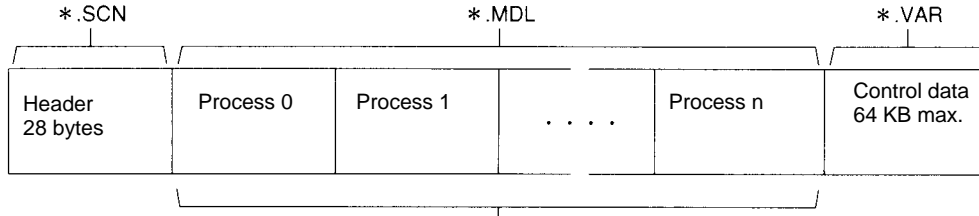

The calculation method differs depending on the measurement items that are set.

Measurement item	Calculation method
Position compensation	For each model: $X \times Y \times 3 + 200$ (bytes) <div style="display: flex; justify-content: center; gap: 20px;"> <div style="border: 1px solid black; width: 50px; height: 15px; margin: 0 auto;"></div> <div style="border: 1px solid black; width: 30px; height: 15px; margin: 0 auto;"></div> </div> <p style="text-align: center;">Model image    Model information</p>
Rotation positioning	<div style="display: flex; align-items: center; justify-content: center;"> <div style="margin-right: 5px;">Y</div> <div style="border: 1px solid black; padding: 5px; text-align: center;"> <div style="margin-bottom: 5px;">X</div> <div style="margin: 0 auto; width: 60px; height: 40px; display: flex; align-items: center; justify-content: center;"> <span>Model</span> </div> </div> </div>



# Index

## Numbers

3Z4S-LT, 9

## A

application program  
  installation, 10  
  quitting, 13  
  starting, 10

auto-registration, 91

automatic measurement, 137

automatic model registration, 74, 92

## B

background suppression level  
  copying, 48  
  setting, 47

Base Units, 8

basic operation, 14

BGS. *See* background suppression level

## C

C.Camera  
  B.BGS Level, 47  
  F.Filtering, 43

cables, 9

calibration  
  data checking, 58  
  data setting, 25, 49, 52  
  distortion compensation, 55  
  numeric, 57  
  registering models, 49  
  sampling, 52

Camera I/F Units, 8

camera numbers, selecting, 43

Cameras, 8

candidate points, checking, 70

circle positioning, 101

comment line, 15

comments, adding to scenes, 35

Console, 8, 14, 87, 122

copyright, 2

## D

D.Disp  
  F.Freeze, 36  
  I.Input Image, 37  
  P.Input Image After Position Compensation, 38

defect rotation, 110

dialog boxes, 15, 16

Direction Keys, function, 14

DSX-240, 9

Dummy Unit, 9

## E

edge enhancement, 45

Enter Key, function, 14

ERR signal ON messages, 144

error messages, 144

Escape Key, function, 14

## F

F200-S, 8

F300-A20R, 8

F300-A22S, 8

F300-D2, 9

F300-G, 9

F300-KP, 14

F300-S2R, 8

F300-A20, 8

F300-A22RS, 8

F300-A23RS, 8

F300-B32, 8

F300-B52, 8

F300-DC2, 9

F300-E2, 9

F300-FM2, 8

F300-FS, 9

F300-N256/N512, 9

F300-P2/P2E, 8

F300-S3DR, 8

F300-S4R, 8

F309-VFS, 9

F309-VSR2, 8

F309-VR, 9

F350-C12E, 8

filtering, 43

- all edges, 46
- copying settings, 46
- edge enhancement, 45
- horizontal edges, 45
- procedure, 46
- smoothing, 44
- vertical edges, 45

freezing, images, 36

## H—I

Help Key, function, 14

I.Installation, 10

images

- display method, 36
- displaying, 37
- freezing, 36
- input, 37
- position compensation, 38

IMP Unit, 8

- scene data backup, 33

inputting

- characters, 18
- minus sign, 17
- numbers, 17
- settings, 16

installation, 10

instructions

- from Parallel I/O Unit, 88, 123
- input timing, 85, 121
- inputting, 122
  - from console, 125
  - from Parallel I/O Unit, 127
  - via RS-232C, 125
- timing charts, 129
- via RS-232C, 88, 122

## J—L

judgement conditions, setting, 88

keys

- Direction Keys, 14
- Enter Key, 14
- Escape Key, 14
- Help Key, 14
- Shift Key, 14

line brightness, 138

## M

M.Application program (memory card), 10

M.Initial Mode, 137

M.Meas, 85, 121

M.Measure, 124

O.Measure monitor, 85, 121

manuals, 3

mask regions, setting, 66

measurement items

- copying, 41
- setting, 39
- setting processes, 38
- settings, clearing, 42

measurement models

- clearing, 73
- modifying, 64
- registering, 62

measurement screens, 124

measurement times, monitoring, 85

measurements, 29, 124

- automatic, 137
- checking values, 85
- monitoring, position compensation, 121

Memory Cards, 9

- precautions, 2
- scene data backup, 33

menu bar, 15

menu boxes, 15

menus, 15

- hierarchy, 15
- diagrams, 147
- selecting, 15

message boxes, 15

minus sign, 17

MMI Unit, 8

models

- clearing pairings, 84
- pairing, 79
- setting conditions, 71

Monitor Cable, 8

monitors

- measure value, 87
- search, 86

## O

O.Model information, 141

one-model positioning, 91

one-model rotation, 105

operation, basic, 14

output conditions, setting, 84

OVL, 3

## P

- P.Posi Cmp, 90
  - A.Region, 117
  - C.Conditions, 119
  - P.Speed, 118
  - R.Registration, 90
  - S.Reference, 120
  - T.Rotation angle, 115
- P.Rot posi, 60
  - 2.2-model pairings, 78
  - M.Model registration, 62
  - O.Output conditions, 84
  - P.Rotation angle, 60
- Parallel I/O Unit, 9
- peripheral devices, 9
- personal computers, 9
- pitch settings, 60
- PLC. *See* Programmable Controller
- position compensation, 90
  - automatic region registration, 92, 99
  - circle positioning, 101
    - defect rotation, 110
    - no rotation, 102
    - one-model rotation, 105
  - conditions, 119
  - description, 10
  - input image, 38
  - manual region registration, 96, 99
  - modes, 90
  - monitoring settings, 120
  - one-model positioning, 91
  - reducing rotation models, 39
  - region, 117
  - rotation angle, 115
  - setting, 23
  - speed, 118
  - two-model positioning, 98
- Power Supply Unit, 8
- precautions
  - Memory Cards, 2
  - turning off power, 13
- processes
  - selecting, 41
  - setting, 23
- Programmable Controller, 9

## R

- reference position, 91
- region. *See* position compensation, region; read regions
- rotation compensation parameters, 115
- rotation parameters, setting, 60
- rotation positioning, 60
  - automatic region registration, 74
  - setting, 26

- RS-232C Cable, 9
- RS-232C I/F Unit, 9

## S

- S.Reference, 120
- S.Scene, 33
  - C.Copy, 34
  - L.Clear, 35
  - N.Enter Comment, 35
- scene data backup, Memory Cards, 33
- scene numbers. *See* scenes, numbers
- scenes, 33
  - clearing, 35
  - comments
    - displaying, 33
    - entering, 35
  - copying, 34
  - data size, 151
  - loading, 139
  - number, selecting, 33
  - numbers
    - initial, 33
    - inputting, 17
    - selecting, 22
    - saving, 138
- screen displays, 15
- search regions, setting, 69
- search verification, 91
- settings
  - basic, 33
  - data, 16
    - toggle boxes, 17
  - evaluation criteria, 17
  - scene numbers, 17
- Setup Menu, 10
- Shift Key, function, 14
- smoothing, 44
- STEP signal, 22, 38
- Strobe Cable, 9
- Strobe Device, 9
- Strobe I/F Unit, 9
- strobes , 36
- Synchronization Sensor, 9
- system configuration, 8

## T

- T.Rotation angle, 115
- Terminal Block Unit , 9
- timing charts, 129
- toggle boxes, 15, 17
- troubleshooting, 144
- two-model positioning, 98

## U–Y

U.Proc, 38

  C.Copy, 41

Video Monitor, 8

  displaying images , 36

Y.Sys, 137

  L.Line brightness, 138

  M.Initial mode, 137

  O.Model information, 141

  S.Scene data, 138

