



Machine Automation Controller NJ-series

EtherNet/IP™ Connection Guide

OMRON Corporation

CJ2-series Controller

Network
Connection
Guide

About Intellectual Property Rights and Trademarks

Microsoft product screen shots reprinted with permission from Microsoft Corporation.

Windows is a registered trademark of Microsoft Corporation in the USA and other countries.

ODVA and EtherNet/IP™ are trademarks of ODVA.

EtherCAT® is registered trademark and patented technology, licensed by Beckhoff Automation GmbH, Germany.

Sysmac is a trademark or registered trademark of OMRON Corporation in Japan and other countries for OMRON factory automation products.

Company names and product names in this document are the trademarks or registered trademarks of their respective companies.

Table of Contents

1. Related Manuals	1
2. Terms and Definitions	2
3. Precautions	3
4. Overview	4
5. Applicable Devices and Device Configuration	5
5.1. Applicable Devices	5
5.2. Device Configuration	6
6. EtherNet/IP Settings	8
6.1. EtherNet/IP Communications Parameters	8
6.2. Allocating the Tag Data Links	8
7. EtherNet/IP Connection Procedure	9
7.1. Work Flow	10
7.2. Setting Up the PLC	11
7.3. Setting Up the Controller	21
7.4. Setting Up the Network	28
7.5. Checking the EtherNet/IP Communications	32
8. Initialization Method	38
8.1. Initializing the Controller	38
8.2. Initializing the PLC	41
9. Appendix 1 Detailed Settings of the Tag Data Links	43
9.1. Global Variable Table	43
9.2. Relationship between Destination Device and Global Variables	43
9.3. Associating the Tag Data Links	44
10. Appendix 2 Setting the Tag Data Links Using the Software	45
10.1. Overview of Setting Tag Data Links	45
10.2. Work Flow of "Procedure for Setting Parameters from the Beginning"	46
10.3. Setting Up the Controller without the Configuration Files	48
10.4. Setting Up the Network Using the Software	59
11. Revision History	81

1. Related Manuals

The table below lists the manuals related to this document.

To ensure system safety, make sure to always read and heed the information provided in all Safety Precautions, Precautions for Safe Use, and Precaution for Correct Use of manuals for each device which is used in the system.

Cat. No.	Model	Manual name
W500	NJ501-□□□□ NJ301-□□□□	NJ-series CPU Unit Hardware User's Manual
W501	NJ501-□□□□ NJ301-□□□□	NJ-series CPU Unit Software User's Manual
W506	NJ501-□□□□ NJ301-□□□□	NJ-series CPU Unit Built-in EtherNet/IP™ Port User's Manual
W504	SYSMAC-SE2□□□□	Sysmac Studio Version 1 Operation Manual
W472	CJ2H-CPU6[]-EIP CJ2M-CPU3[]	CJ-series CJ2 CPU Unit Hardware User's Manual
W473	CJ2H-CPU6[]-EIP CJ2M-CPU3[]	CJ-series CJ2 CPU Unit Software User's Manual
W465	CJ2H-CPU6[]-EIP CJ2M-CPU3[]	EtherNet/IP Unit Operation Manual
W446	-	CX-Programmer Operation Manual

2. Terms and Definitions

Term	Explanation and Definition
Node	<p>Controllers and devices are connected to the EtherNet/IP network via the EtherNet/IP ports. The EtherNet/IP recognizes each EtherNet/IP port connected to the network as one node.</p> <p>When a device with two EtherNet/IP ports is connected to the EtherNet/IP network, the EtherNet/IP recognizes this device as two nodes.</p> <p>The EtherNet/IP achieves the communications between controllers or the communications between controllers and devices by exchanging data between these nodes connected to the network.</p>
Tag	<p>A minimum unit of the data that is exchanged on the EtherNet/IP network is called a tag. The tag is defined as a network variable or as a physical address, and it is allocated to the memory area of each device.</p>
Tag set	<p>In the EtherNet/IP network, a data unit that consists of two or more tags can be exchanged. The data unit consisting of two or more tags for the data exchange is called a tag set. Up to eight tags can be configured per tag set for OMRON controllers.</p>
Tag data link	<p>In the EtherNet/IP, the tag and tag set can be exchanged cyclically between nodes without using the user program. This standard feature on the EtherNet/IP is called a tag data link.</p>
Connection	<p>A connection is used to exchange data as a unit within which data concurrency is maintained. The connection consists of tags or tag sets. Creating the concurrent tag data link between the specified nodes is called a "connection establishment". When the connection is established, the tags or tag sets that configure the connection are exchanged between the specified nodes concurrently.</p>
Originator and Target	<p>To perform tag data links, one node requests the opening of a communications line called a "connection".</p> <p>The node that requests opening the connection is called "originator", and the node that receives the request is called a "target".</p>
Tag data link parameter	<p>The tag data link parameter is the setting data to perform the tag data link. It includes the data to set tags, tag sets, and connections.</p>

3. Precautions

- (1) Understand the specifications of devices which are used in the system. Allow some margin for ratings and performance. Provide safety measures, such as installing safety circuit in order to ensure safety and minimize risks of abnormal occurrence.
- (2) To ensure system safety, always read and heed the information provided in all Safety Precautions, Precautions for Safe Use, and Precaution for Correct Use of manuals for each device used in the system.
- (3) The user is encouraged to confirm the standards and regulations that the system must conform to.
- (4) It is prohibited to copy, to reproduce, and to distribute a part or the whole of this document without the permission of OMRON Corporation.
- (5) The information contained in this document is current as of September 2013. It is subject to change without notice for improvement.

The following notation is used in this document.



WARNING

Indicates a potentially hazardous situation which, if not avoided, will result in minor or moderate injury, or may result in serious injury or death. Additionally there may be significant property damage.



Precautions for Safe Use

Precautions on what to do and what not to do to ensure safe usage of the product.



Precautions for Correct Use

Precautions on what to do and what not to do to ensure proper operation and performance.



Additional Information

Additional information to read as required.

This information is provided to increase understanding or make operation easier.

Symbol



The filled circle symbol indicates operations that you must do.
The specific operation is shown in the circle and explained in text.
This example shows a general precaution for something that you must do.

4. Overview

This document describes the procedure for connecting CJ2 Programmable Controller + EtherNet/IP Unit (hereinafter referred to as the PLC) of OMRON Corporation (hereinafter referred to as OMRON) to NJ-series Machine Automation Controller (hereinafter referred to as the Controller) via EtherNet/IP and provides the procedure for checking their connection. It also contains the procedure for performing EtherNet/IP tag data link using the EtherNet/IP settings of the project file that is prepared beforehand (hereinafter referred to as the "procedure for using the configuration files").

Section 9 A-1 and Section 10 A-2 describe the procedures for setting parameters with software without using files (hereinafter referred to as the "procedure for setting parameters from beginning").

To follow the "procedure for using configuration files", obtain the latest "Sysmac Studio project file" and "Network Configurator v3 network configuration file" (they are referred to as "configuration files") from OMRON in advance.

Name	File name	Version
Sysmac Studio project file (extension: smc)	OMRON_CJ2_EIP_EV101.smc	Ver.1.01
Network Configurator v3 network configuration (extension: nvf)	OMRON_CJ2_EIP_EV101.nvf	Ver.1.01

5. Applicable Devices and Device Configuration

5.1. Applicable Devices

The applicable devices are as follows:

Manufacturer	Name	Model
OMRON	NJ-series CPU Unit	NJ501-□□□□ NJ301-□□□□
OMRON	CJ2 CPU Unit	CJ2□-CPU□□
OMRON	EtherNet/IP Unit	CJ1W-EIP21 CJ2H-CPU6□-EIP CJ2M-CPU3□



Precautions for Correct Use

As applicable devices above, the devices with the models and versions listed in Section 5.2. are actually used in this document to describe the procedure for connecting devices and checking the connection.

You cannot use devices with versions lower than the versions listed in Section 5.2.

To use the above devices with versions not listed in Section 5.2 or versions higher than those listed in Section 5.2, check the differences in the specifications by referring to the manuals before operating the devices.



Additional Information

This document describes the procedure to establish the network connection. Except for the connection procedure, it does not provide information on operation, installation or wiring method. It also does not describe the functionality or operation of the devices. Refer to the manuals or contact your OMRON representative.

5.2. Device Configuration

The hardware components to reproduce the connection procedure of this document are as follows:

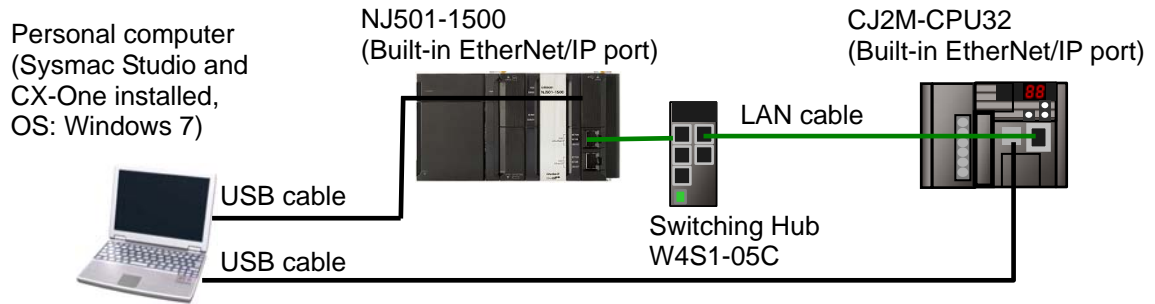

Manufacturer	Name	Model	Version
OMRON	NJ-series CPU Unit (Built-in EtherNet/IP port)	NJ501-1500	Ver.1.05
OMRON	Power Supply Unit	NJ-PA3001	
OMRON	Switching Hub	W4S1-05C	Ver.1.00
OMRON	Sysmac Studio	SYSMAC-SE2[] [] [] []	Ver.1.06
OMRON	Network-Configurator	(Included in Sysmac Studio.)	Ver.3.55
OMRON	Sysmac Studio project file	OMRON_CJ2_EIP_EV101.smc	Ver.1.01
OMRON	Network Configurator v3 network configuration file	OMRON_CJ2_EIP_EV101.nvf	Ver.1.01
-	Personal computer (OS: Windows7)	-	
-	USB cable (USB 2.0 type B connector)	-	
-	LAN cable (STP (shielded, twisted-pair) cable of Ethernet category 5 or higher)	-	
OMRON	PLC CPU Unit (Built-in EtherNet/IP port)	CJ2M-CPU32 (Built-in CJ2M-EIP21)	Ver.2.0 (Ver.2.1)
OMRON	Power Supply Unit	CJ1W-PA202	
OMRON	CX-One	CXONE-AL[] [] [] C-V4 /AL[] [] [] D-V4	Ver.4. [] []
OMRON	CX-Programmer	(Included in CX-One.)	Ver.9.43



Precautions for Correct Use

Prepare the latest "Sysmac Studio project file" and "Network Configurator v3 network configuration file" from OMRON in advance.

(To obtain the files, contact your OMRON representative.)



Precautions for Correct Use

Update the Sysmac Studio and CX-Programmer to the versions specified in this section or higher versions using the auto update function.

If a version not specified in this section is used, the procedures described in Section 7 and subsequent sections may not be applicable. In that case, use the equivalent procedures described in the Sysmac Studio Version 1 Operation Manual (Cat. No. W504), Network Configurator Online Help and CX-Programmer Operation Manual (Cat. No. W466).



Additional Information

The system configuration in this document uses USB for the connection to the Controller. For information on how to install a USB driver, refer to *A-1 Driver Installation for Direct USB Cable Connection* of the *Sysmac Studio Version 1 Operation Manual* (Cat. No. W504).



Additional Information

The system configuration in this document uses USB for the connection between the personal computer and PLC. For information on how to install the USB driver, refer to *A-5 Installing the USB Driver* of the *CJ-series CJ2 CPU Unit Hardware User's Manual* (Cat. No. W472).

6. EtherNet/IP Settings

This section describes the specifications such as communication parameters and tag data link that are defined in this document.

Hereinafter, the PLC is referred to as the "destination device" in some descriptions.

6.1. EtherNet/IP Communications Parameters

The communications parameters required to connect the Controller and the destination device via EtherNet/IP are given below.

	Controller (Node 1)	PLC (Node 2)
IP address	192.168.250.1	192.168.250.2
Subnet mask	255.255.255.0	255.255.255.0

6.2. Allocating the Tag Data Links

The data in the tag data links of the destination device are allocated to the global variables of the Controller. The relationship between the device data and the global variables is shown below.

The following global variables are defined in the "Configuration file".

■Output area (Controller → PLC)

Offset	Destination device data	Global variable	Data type	Retained
+0 to +9	PLC D10100 onwards (20byte)	EIP002_D10100_OUT	WORD[10]	Retained

■Input area (Controller ← PLC)

Offset	Destination device data	Global variable	Data type	Retained
+0 to +9	PLC D10000 onwards (20byte)	EIP002_D10000_IN	WORD[10]	Retained



Additional Information

With the Sysmac Studio, two methods can be used to specify an array for a data type. After specifying, (1) is converted to (2) and the data type is always displayed as (2).

(1)WORD[3]/(2)ARRAY[0..2]OF WORD

In this document, the data type is simplified by displaying WORD[3].

(The example above means a WORD data type with three array elements.)

7. EtherNet/IP Connection Procedure

This section describes the procedure for connecting the PLC and the Controller via EtherNet/IP using the "procedure for using configuration files".

This document explains the procedures for setting up the Controller and the PLC from the factory default setting. For the initialization, refer to *Section 8 Initialization Method*.

■ Setting Overview

The following figure shows the relationship between the processes to operate the EtherNet/IP tag data link using the "procedure for using configuration files".

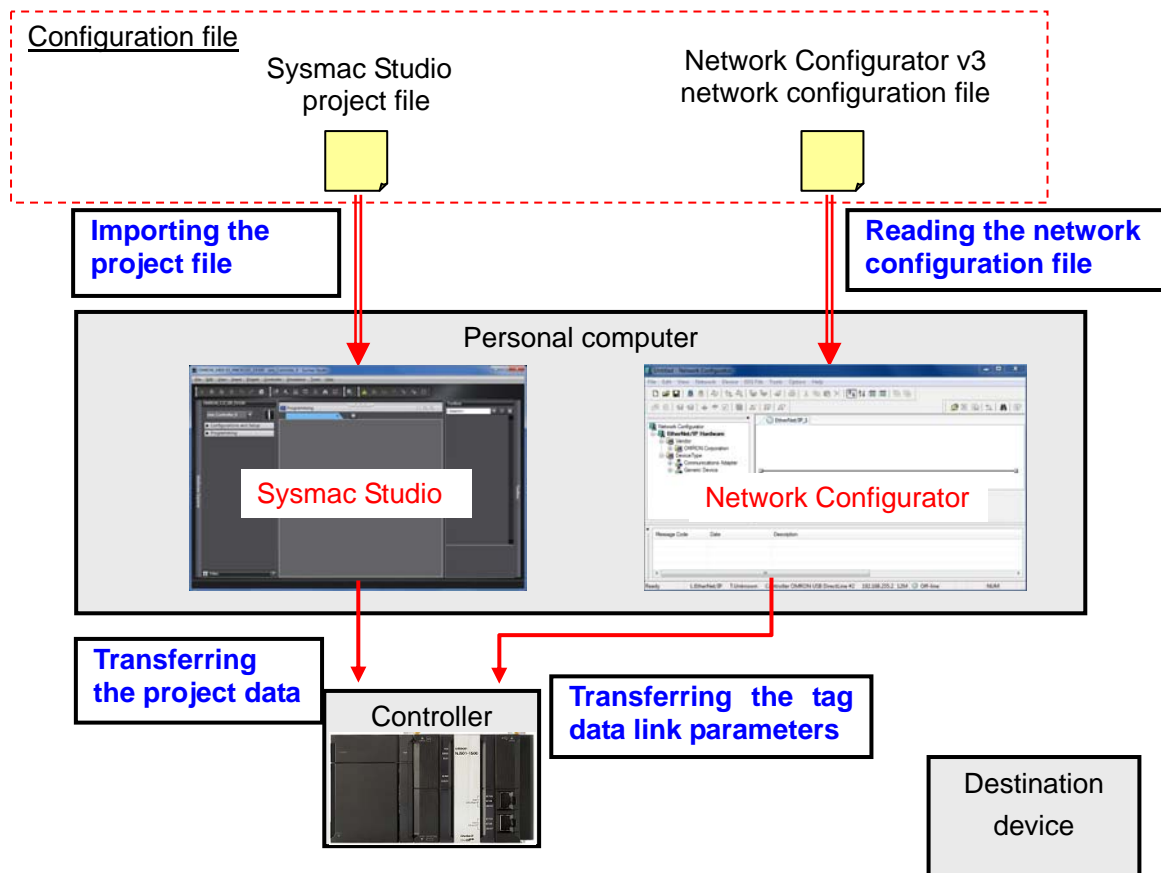

Precautions for Correct Use

Prepare the latest "Sysmac Studio project file" and "Network Configurator v3 network configuration file" from OMRON in advance.

(To obtain the files, contact your OMRON representative.)

7.1. Work Flow

Take the following steps to operate the tag data link for EtherNet/IP.

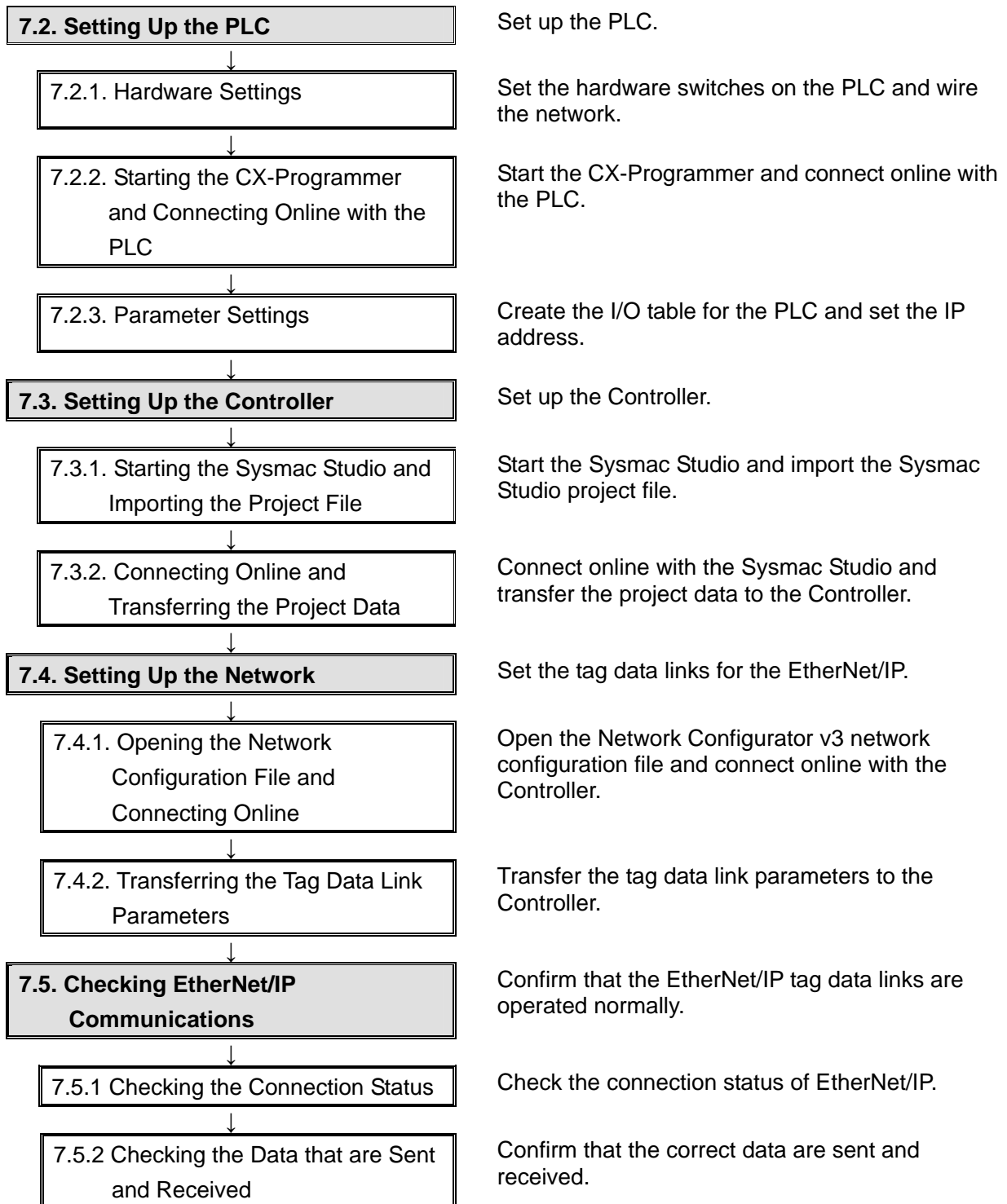

7.2. Setting Up the PLC

Set up the PLC.

7.2.1. Hardware Settings

Set the hardware switches on the PLC and wire the network.



Precautions for Correct Use

Make sure that the power supply is OFF when you perform the setting up.

- 1 Make sure that the power supply to the PLC is OFF.

*If the power supply is turned ON, settings may not be applicable as described in the following procedure.

- 2 Check the hardware switches located on the front panel of the EtherNet/IP Unit by referring to the right figure.

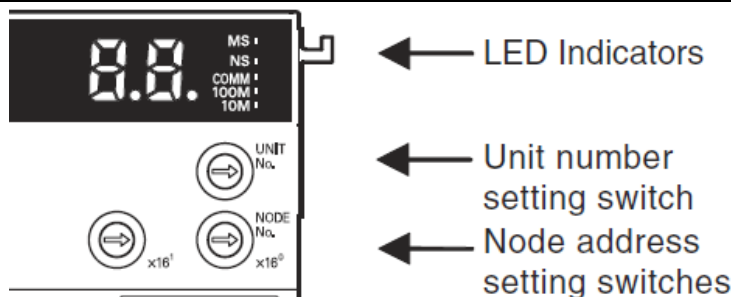

- 3 Set the unit number setting switch to 0.

The unit number is used to identify individual CPU Bus Units when more than one CPU Bus Unit is mounted to the same PLC. Use a small screwdriver to make the setting, taking care not to damage the rotary switch. The unit number is factory-set to 0.

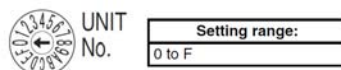

- 4 Set the node address setting switches as follows:

[NODE No.x16¹]: 0
[NODE No.x16⁰]: 2

IP address: 192.168.250.2

*By default, the first to third octets of the local IP address are fixed to 192.168.250. The fourth octet is the values that were set with the node address setting switches.

With the FINS communications service, when there are multiple EtherNet/IP Units connected to the Ethernet network, the EtherNet/IP Units are identified by node addresses. Use the node address switches to set the node address between 01 and FE hexadecimal (1 to 254 decimal). Do not set a number that has already been set for another node on the same network.

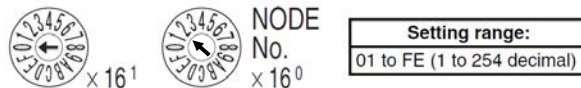

The left switch sets the sixteens digit (most significant digit) and the right switch sets the ones digit (least significant digit). The node address is factory-set to 01.

Default IP address = 192.168.250.node address

With the factory-default node address setting of 01, the default IP address is 192.168.250.1.

- 5 Connect the LAN cable to the EtherNet/IP port of the PLC, and connect the USB cable to the USB port. Connect the personal computer, Switching Hub and PLC as shown in 5.2. Device Configuration.

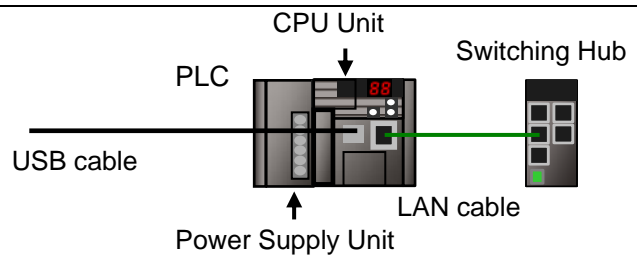

- 6 Turn ON the power supply to the PLC.
The set IP address is displayed on the seven-segment LED indicators from right to left.
Afterwards, the rightmost 8 bits of the IP address are displayed in hexadecimal during normal operation.

7.2.2. Starting the CX-Programmer and Connecting Online with the PLC

Start the CX-Programmer and connect online with the PLC.

Install the CX-One and USB driver in the personal computer beforehand.

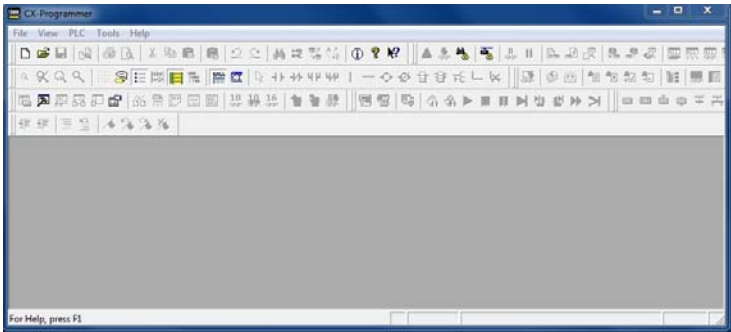
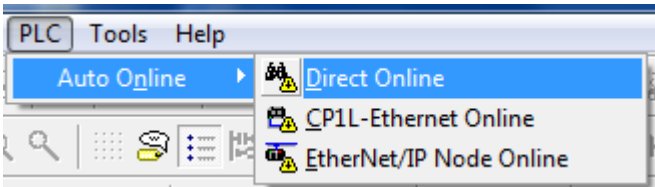
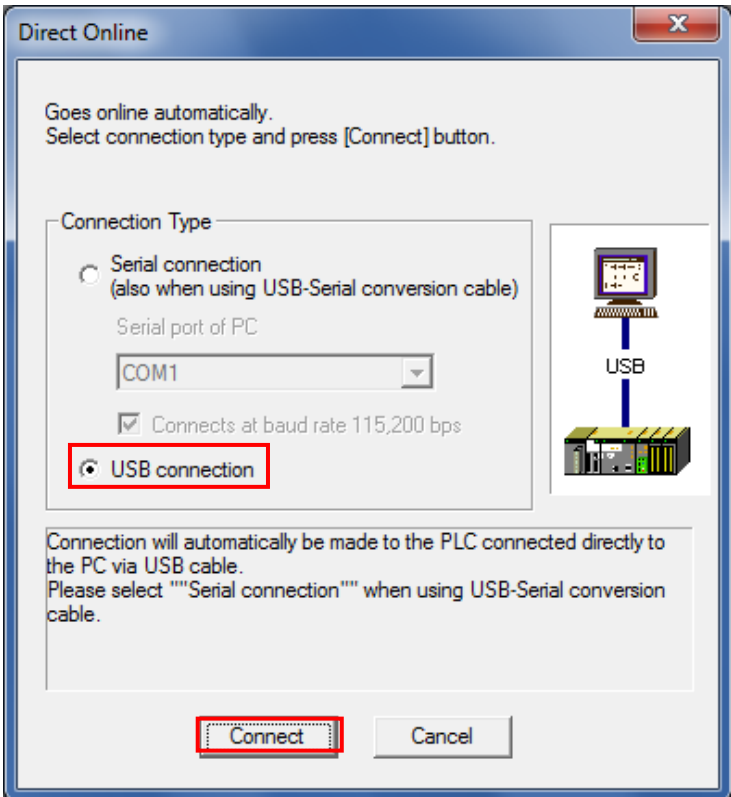
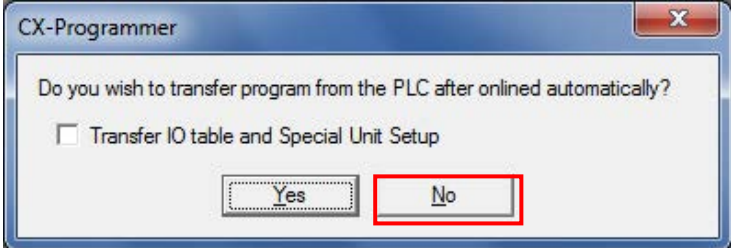
<p>1 Start the CX-Programmer.</p>	
<p>2 Select Auto Online - Direct Online from the PLC Menu.</p>	
<p>3 The Direct Online Dialog Box is displayed. Select the USB Connection Option for Connection Type and click the Connect Button.</p>	
<p>4 The dialog box on the right is displayed. Check the contents and click the No Button.</p>	

- 5 The dialog box on the right is displayed, and the CX-Programmer and the PLC is automatically connected.

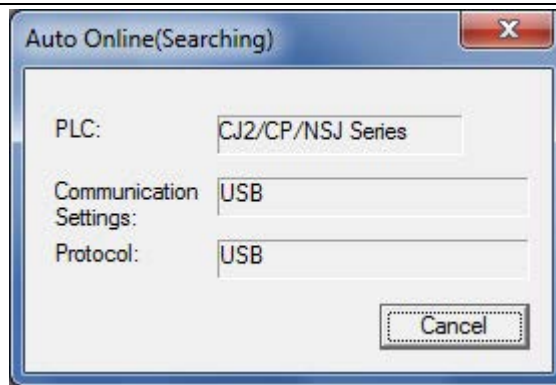

- 6 Confirm that the CX-Programmer and the PLC are normally connected online.

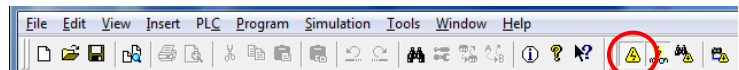

*The  icon is pressed down during online connection.



Additional Information

If the CX-Programmer and PLC are not connected online, please check the connection of the cable.

Or, return to step 2, check the settings and repeat each step.

Refer to *Connecting Directly to a CJ2 CPU Unit Using a USB Cable* in *Chapter 3 Communications* in *PART 3: CX-Server Runtime* of the *CX-Programmer Operation Manual* (Cat. No. W466) for details.



Additional Information

The dialogs explained in the following procedures may not be displayed depending on the environmental setting of CX-Programmer.

For details on the environmental setting, refer to *Options and Preferences* in *Chapter 3 Project Reference* in *PART 1: CX-Programmer* of the *CX-Programmer Operation Manual* (Cat. No. W466). This document explains the setting procedure when the *Confirm all operations affecting the PLC Check Box* is selected.

7.2.3. Parameter Settings

Create the I/O table for the PLC and set the IP address.

1 If the operating mode of the PLC is RUN Mode or Monitor Mode, change it to Program Mode by following the steps below.

(1) Select **Operating Mode - Program** from the PLC Menu of the CX-Programmer.

(2) The dialog box on the right is displayed. Confirm that there is no problem and click the **Yes** Button.

*Refer to *Additional Information* on the previous page for the settings concerning the dialog display.

(3) Confirm that Stop/Program Mode is displayed on the right of the PLC model in the project workspace of the CX-Programmer.

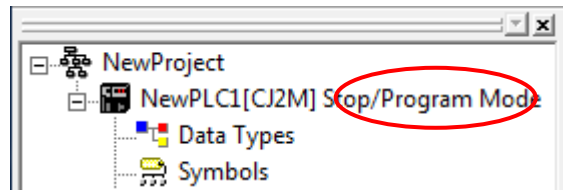
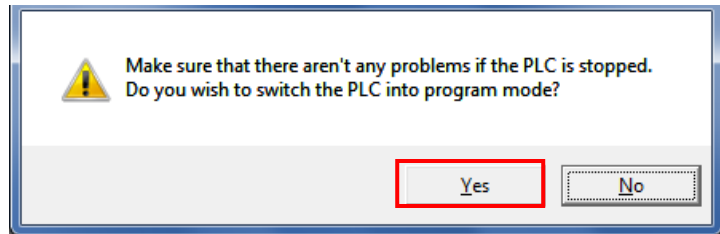
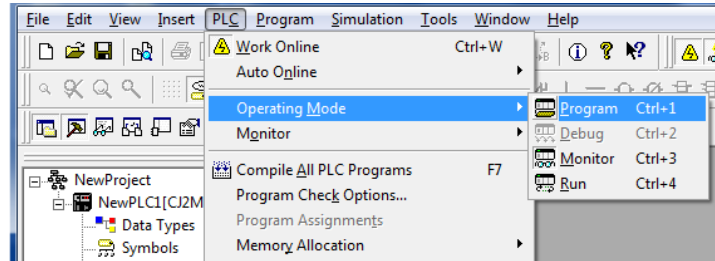
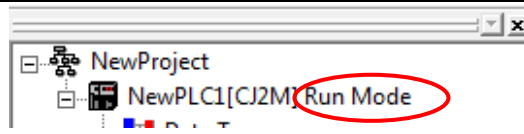

(Project workspace)

- 2 Select **Edit - I/O Table and Unit Setup** from the PLC Menu of the CX-Programmer.

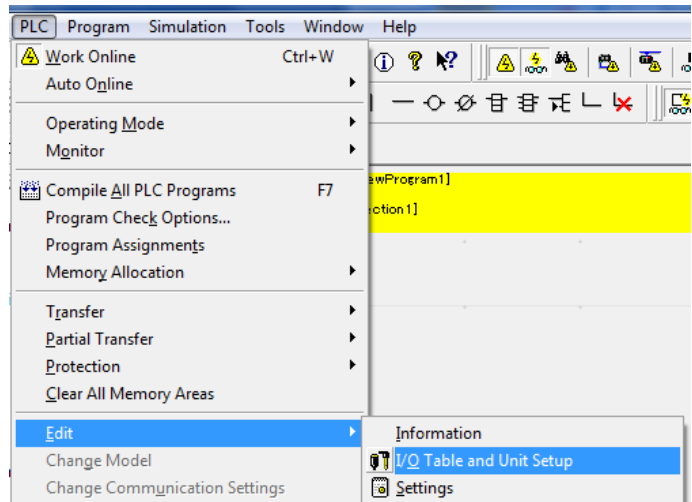

The PLC IO Table Window is displayed.

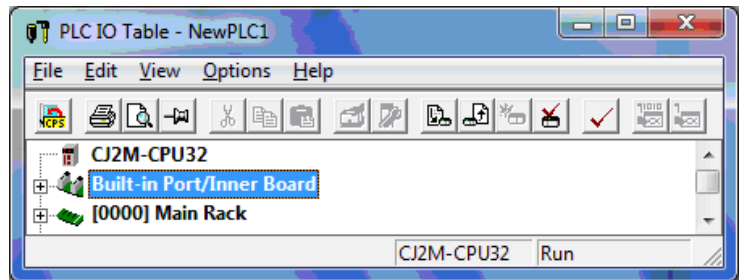

- 3 Select **Create** from the Options Menu of the PLC IO Table Window.

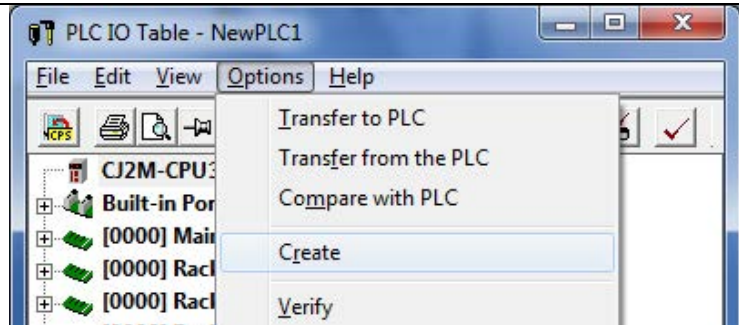

The dialog box on the right is displayed. Confirm that there is no problem and click the **Yes** Button.

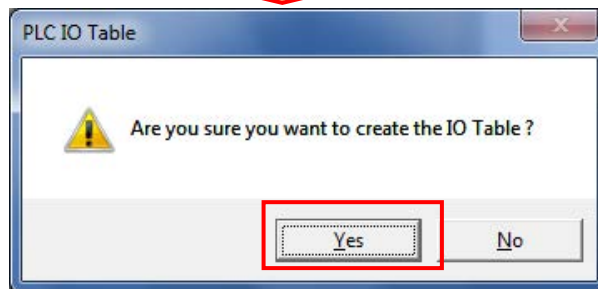

The dialog box on the right is displayed. Confirm that there is no problem and click the **Yes** Button.

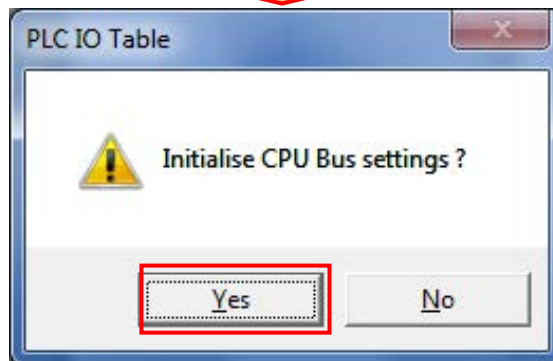

- 4 The Transfer from PLC Dialog Box is displayed. Select the *I/O Table* Check Box and the *SIO Unit Parameters* Check Box, and click the **Transfer** Button.

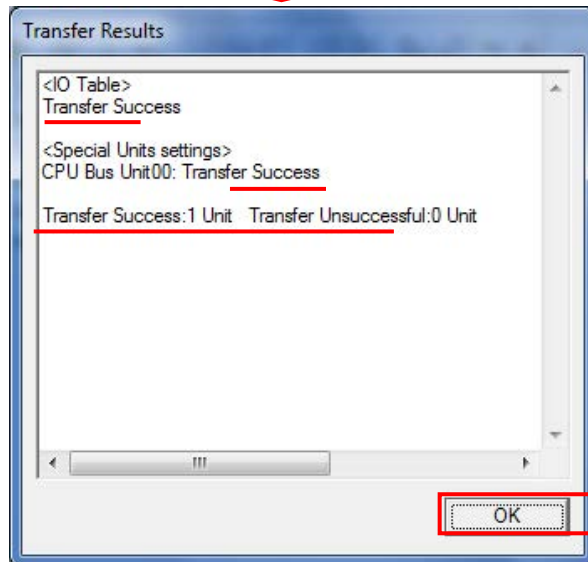
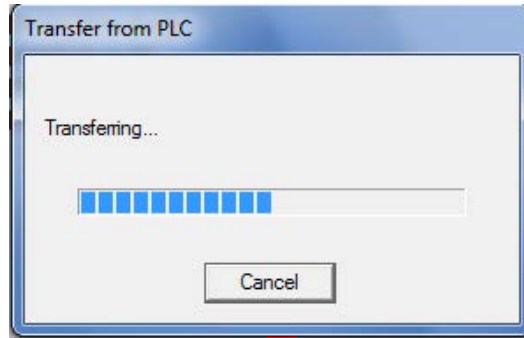
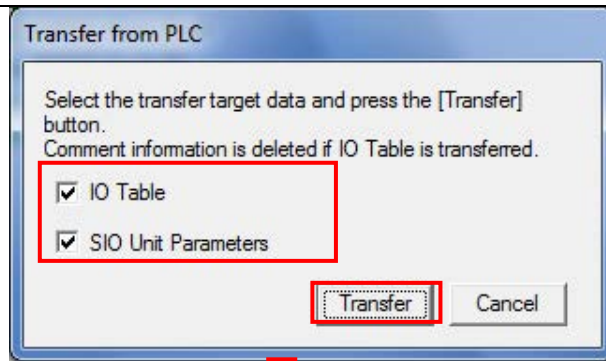

When the transfer is completed, the Transfer Results Dialog Box is displayed.

Confirm that the transfer was normally executed by referring to the message in the dialog box.

When the I/O table is created normally, the dialog box shows the following,

Transfer Success: 1 Unit

Transfer Unsuccessful: 0 Unit

Click the **OK** Button.

- 5 On the PLC IO Table Window, click + to the left of Built-in Port/Inner Board to display CJ2M-EIP21.

*The right figure displays the CPU Unit (built-in EtherNet/IP port) specified in 5.2. Device Configuration. When you use an EtherNet/IP Unit not specified in 5.1. Applicable Devices, the display position and name are different from this figure.

Right-click *CJ2M-EIP21* and select **Unit Setup**.

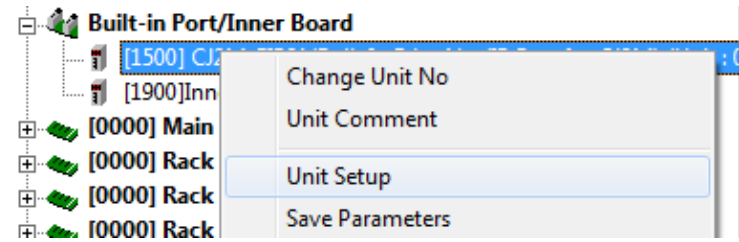
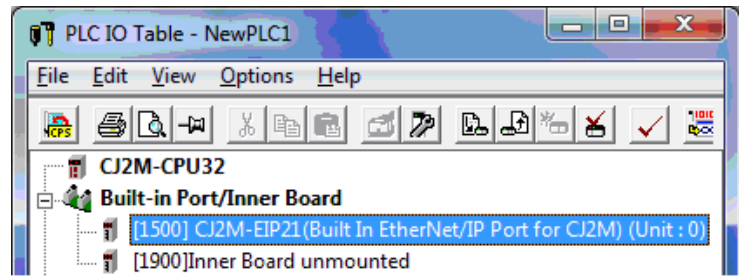

- 6 The Edit Parameters Dialog Box is displayed. Select the TCP/IP Tab.

Make the following settings in the IP Address Field.

- Use the following address:
Select
- IP address: 192.168.250.2
- Subnet mask: 255.255.255.0

Click the **Transfer [PC to Unit]** Button.

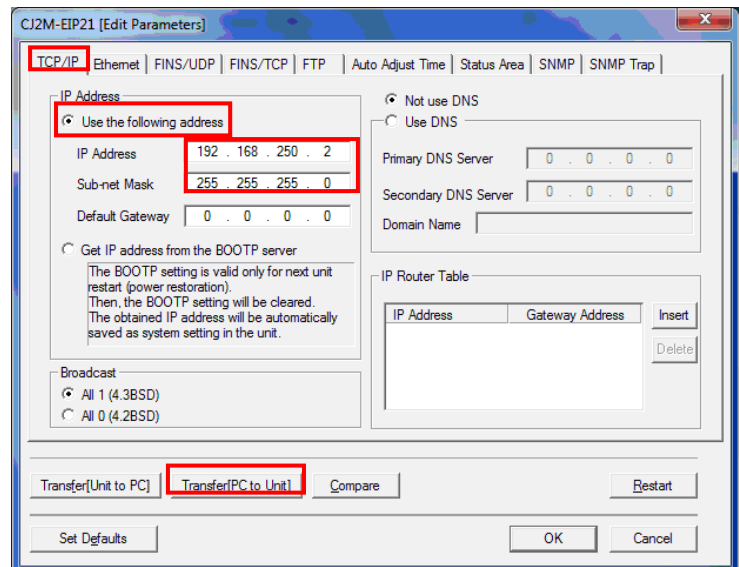

7 The dialog box on the right is displayed. Confirm that there is no problem and click the **Yes** Button.

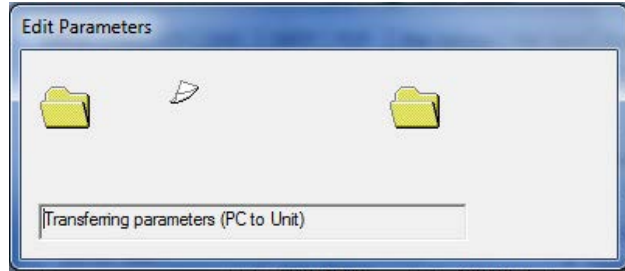
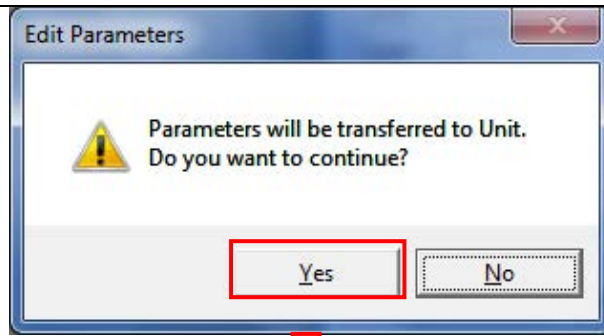

Confirm that parameters were normally transferred to the Unit, and click the **OK** Button.

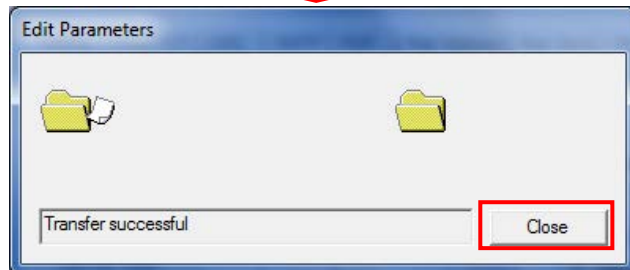

8 A dialog box on the right is displayed. Check the contents and click the **Yes** Button.

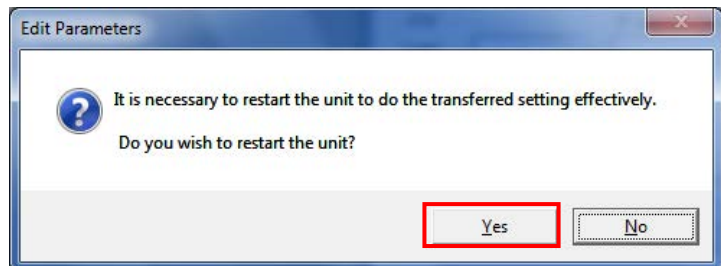

When restarting the Unit is executed, a dialog box shown on the right is displayed. Check the contents and click the **OK** Button

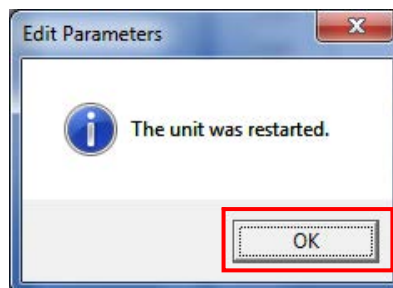

- 9 To confirm that the IP address was correctly changed, click the **Compare** Button.

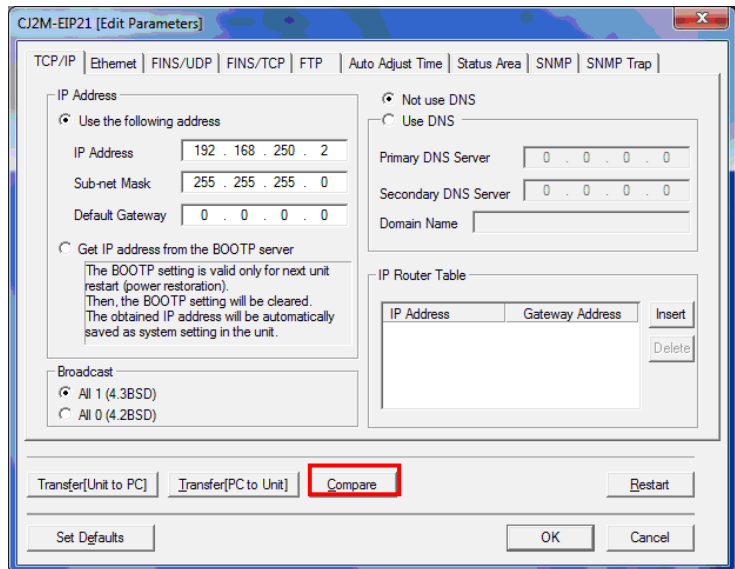

- 10 After confirming that parameters match, click the **OK** Button.

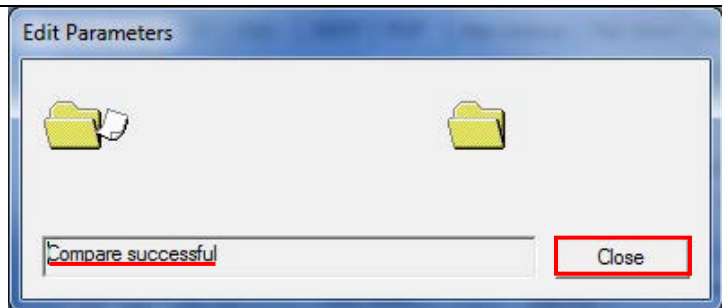

- 11 Click the **OK** Button on the Edit Parameters Dialog Box.

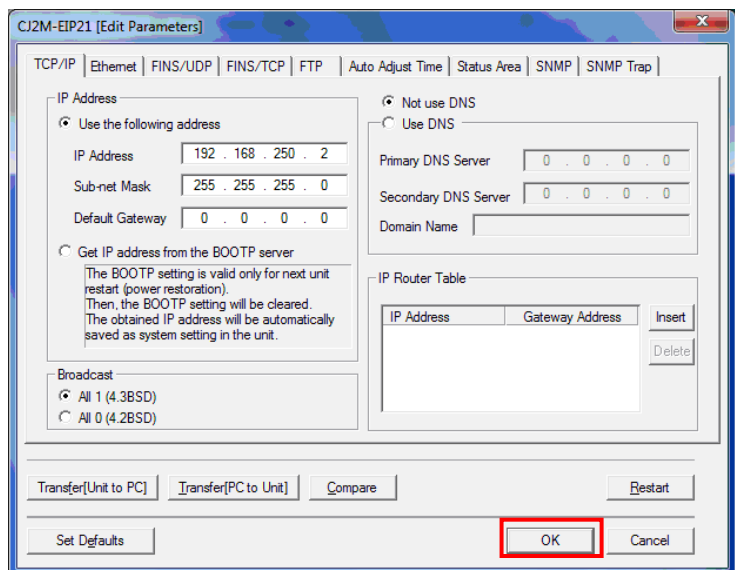

7.3. Setting Up the Controller

Set up the Controller.

7.3.1. Starting the Sysmac Studio and Importing the Project File

Start the Sysmac Studio and import the Sysmac Studio project file.

Install the Sysmac Studio and USB driver in the personal computer beforehand.

- 1 Connect the LAN cable to the built-in EtherNet/IP port (PORT1) of the Controller and connect the USB cable to the peripheral (USB) port. Then connect the personal computer, Switching Hub, and Controller by referring to 5.2. Device Configuration. Turn ON the power supply to the Controller.

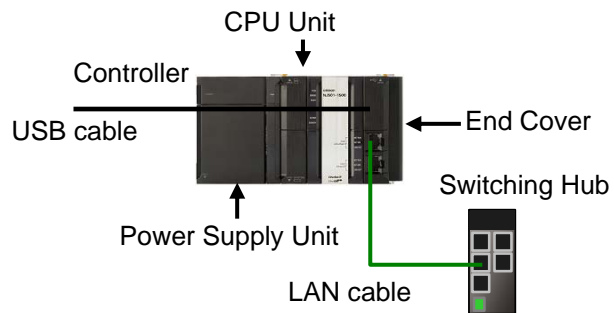

- 2 Start the Sysmac Studio. Click the **Import** Button.

*If a confirmation dialog box for an access right is displayed at start, select to start.

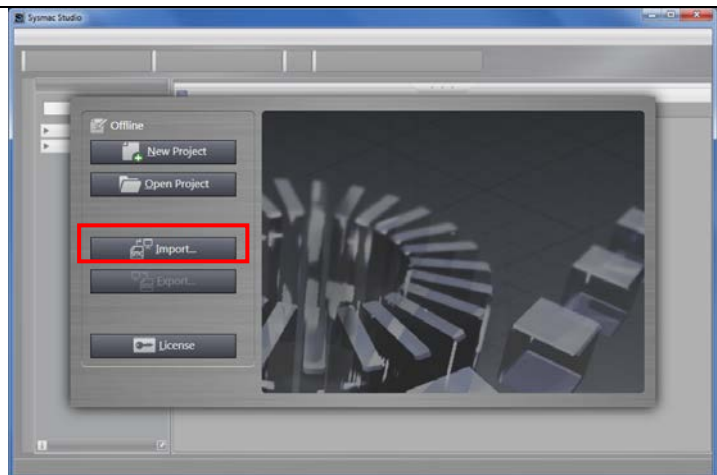

- 3 The Import File Dialog Box is displayed. Select OMRON_CJ2_EIP_EV101.smc (Sysmac Studio project file) and click the **Open** Button.

*Obtain the Sysmac Studio project file from OMRON.

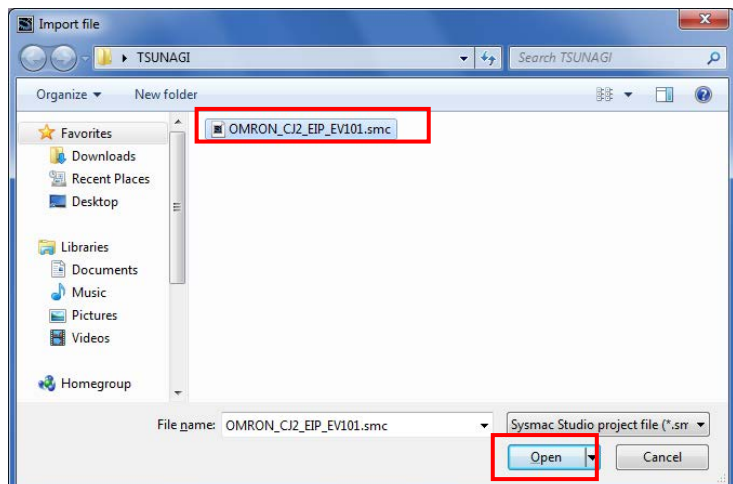

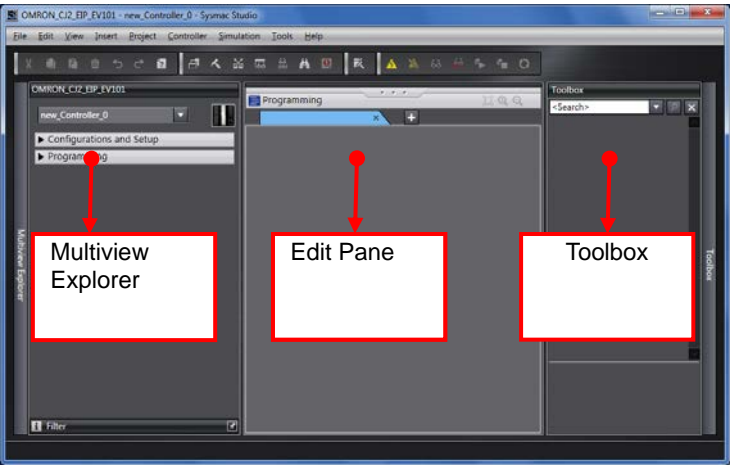
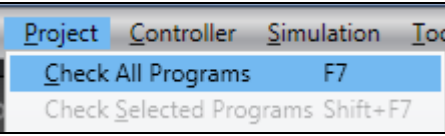
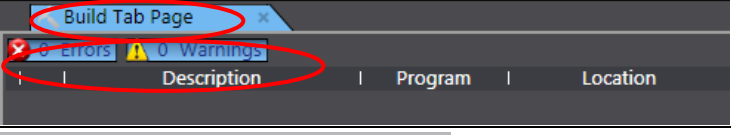
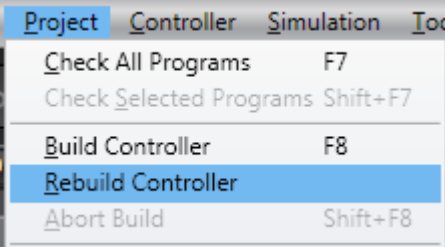
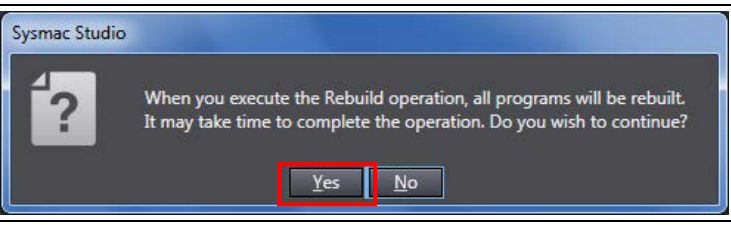
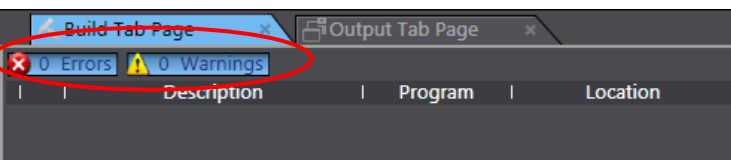
<p>4 The OMRON_CJ2_EIP_EV101 project is displayed. The left pane is called Multiview Explorer, the right pane is called Toolbox and the middle pane is called Edit Pane.</p> <p>*If an error message is displayed stating "Failed to Load Descendants", change the version of the Sysmac Studio to the version specified in 5.2. Device Configuration or higher version.</p>	 <p>The screenshot shows the Sysmac Studio interface with three panes highlighted by red boxes and arrows: 'Multiview Explorer' on the left, 'Edit Pane' in the center, and 'Toolbox' on the right.</p>
<p>5 Select Check All Programs from the Project Menu.</p>	 <p>The screenshot shows the 'Project' menu with 'Check All Programs' selected. The keyboard shortcut 'F7' is visible next to it.</p>
<p>6 The Build Tab Page is displayed in the Edit Pane. Confirm that "0 Errors" and "0 Warnings" are displayed.</p>	 <p>The screenshot shows the 'Build Tab Page' with '0 Errors' and '0 Warnings' displayed. Red circles highlight these counts.</p>
<p>7 Select Rebuild Controller from the Project Menu.</p>	 <p>The screenshot shows the 'Project' menu with 'Rebuild Controller' selected. The keyboard shortcut 'F8' is visible next to it.</p>
<p>8 A confirmation dialog box is displayed. Confirm that there is no problem and click the Yes Button.</p>	 <p>The screenshot shows a confirmation dialog box titled 'Sysmac Studio' with the text: 'When you execute the Rebuild operation, all programs will be rebuilt. It may take time to complete the operation. Do you wish to continue?'. The 'Yes' button is highlighted with a red box.</p>
<p>9 Confirm that "0 Errors" and "0 Warnings" are displayed in the Build Tab Page.</p>	 <p>The screenshot shows the 'Build Tab Page' with '0 Errors' and '0 Warnings' displayed. Red circles highlight these counts.</p>

7.3.2. Connecting Online and Transferring the Project Data

Connect online with the Sysmac Studio and transfer the project data to the Controller.

WARNING

Always confirm safety at the destination node before you transfer a user program, configuration data, setup data, device variables, or values in memory used for CJ-series Units from the Sysmac Studio.

The devices or machines may perform unexpected operation regardless of the operating mode of the CPU Unit.

- 1 Select **Change Device** from the Controller Menu.

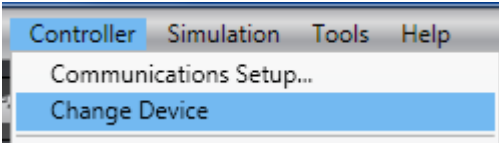

- 2 The Change Device Dialog Box is displayed.
Confirm that Device and Version to use are set as shown on the right.

*If the settings are different, select the setting items from the pull-down list.

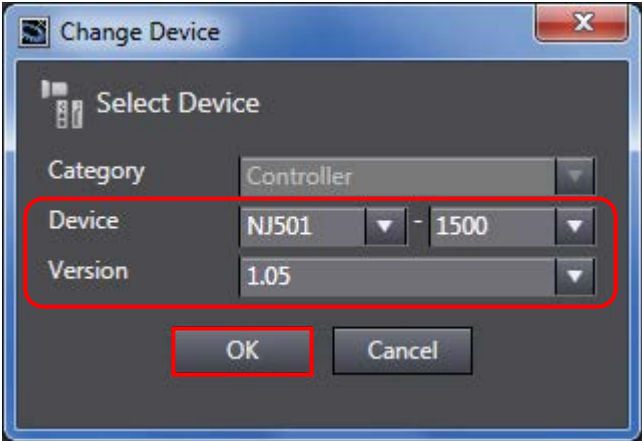
Click the **OK** Button.

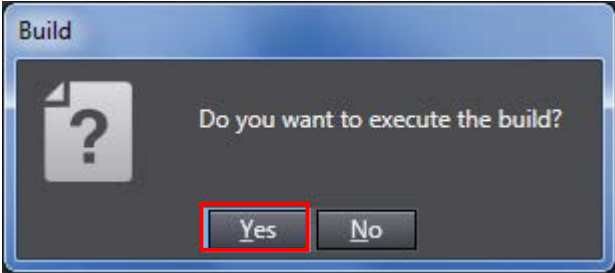

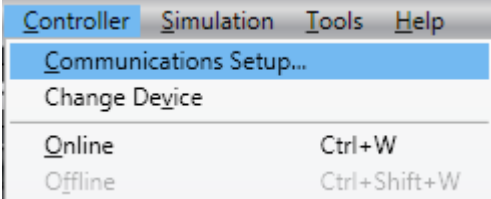
- 3 If the settings were changed in step 2, the Build Dialog Box is displayed. Check the contents and click the **Yes** Button.

- 4 Select **Communications Setup** from the Controller Menu.

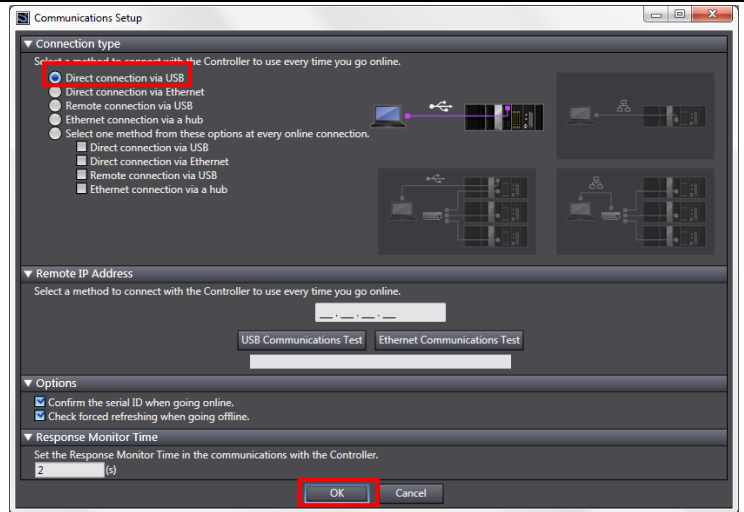

- 5 The Communications Setup Dialog Box is displayed.
Select the *Direct connection via USB* Option for Connection Type.

Click the **OK** Button.



- 6 Select **Online** from the Controller Menu.

*If the dialog box on the right is displayed, the model or version of the Controller does not match that of the project file. Match the Controller model and version by changing the device settings of the project file, and then repeat the procedure from step 1 in this section. Close the dialog box by clicking the **OK** Button.

*The model and version displayed on the confirmation dialog box differ depending on the Controller used and the device setting of the project file. Close the dialog box by clicking the **OK** Button.

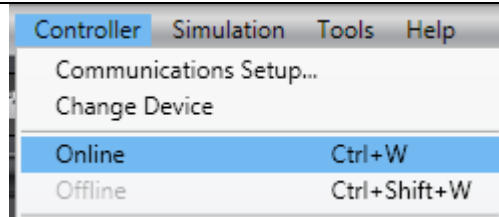

*Example of confirmation dialog box

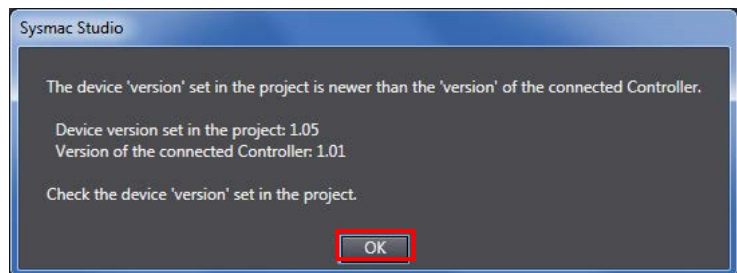
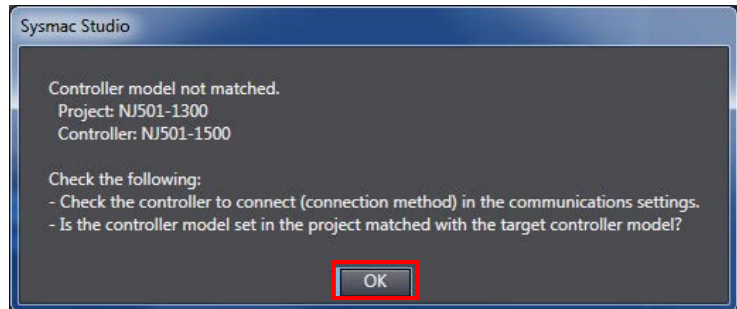



Additional Information

For details on online connections to a Controller, refer to *Section 5 Online Connections to a Controller* of the *Sysmac Studio Version 1 Operation Manual* (Cat. No. W504).

<p>7 A confirmation dialog box is displayed as shown on the right. Confirm that there is no problem and click the Yes Button.</p> <p>*The displayed dialog box depends on the status of the Controller used. Click the Yes Button to proceed with the processing.</p> <p>*The displayed serial ID differs depending on the device.</p>	
<p>8 When an online connection is established, a yellow bar is displayed on the top of the Edit Pane.</p>	
<p>9 Select Synchronization from the Controller Menu.</p>	

10 The Synchronization Dialog Box is displayed.

Confirm that the data to transfer (NJ501 in the right dialog box) is selected. Then, click the **Transfer To Controller** Button.

*After executing Transfer To Controller, the Sysmac Studio data is transferred to the Controller and the data are compared.

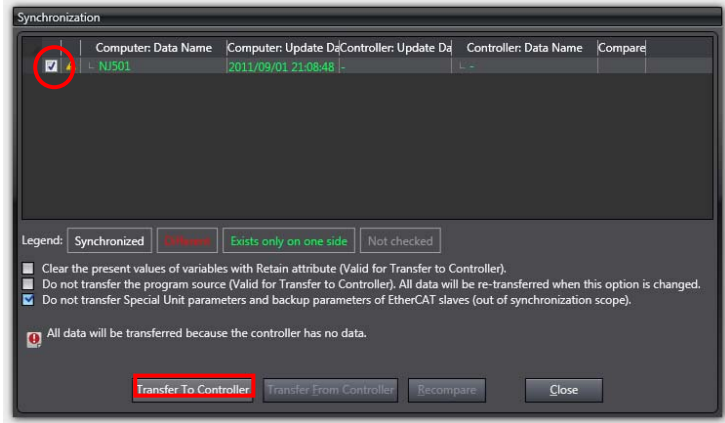

11 A confirmation dialog box is displayed. Confirm that there is no problem and click the **Yes** Button.

A screen stating "Synchronizing" is displayed.

A confirmation dialog box is displayed. Confirm that there is no problem and click the **No** Button.

*Be sure not to return it to "RUN mode".

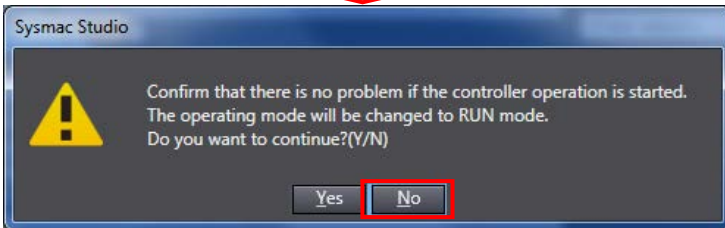
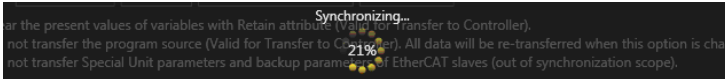
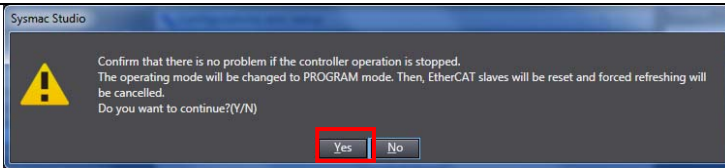

- 12 Confirm that the synchronized data is displayed with the color specified by "Synchronized" and that a message is displayed stating "The synchronization process successfully finished". If there is no problem, click the **Close** Button.

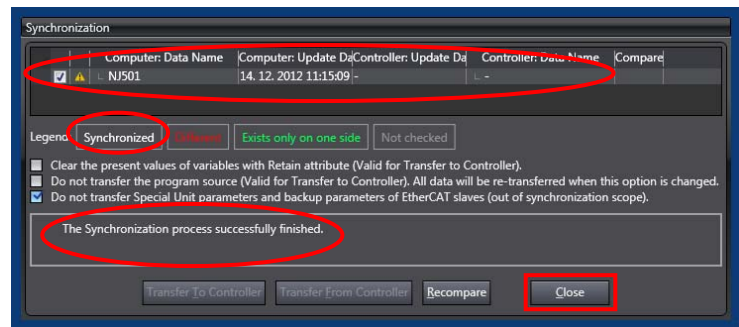

*A message stating "The synchronization process successfully finished" is displayed if the Sysmac Studio project data and the data in the Controller match.

*If the synchronization fails, check the wiring and repeat from step 6.

7.4. Setting Up the Network

Set the tag data links for EtherNet/IP.

7.4.1. Opening the Network Configuration File and Connecting Online

Start up the Network Configurator, open the Network Configurator v3 network configuration file, and connect online with the Controller.



Precautions for Correct Use

Please confirm that the LAN cable is connected before performing the following procedure. When it is not connected, turn OFF the power supply to each device and then connect the LAN cable.

<p>1 Start the Network Configurator.</p>	
<p>2 Select Open from the File Menu.</p>	
<p>3 The Open Dialog Box is displayed. Select OMRON_CJ2_EIP_EV101.nvf (Network Configurator v3 network configuration file) and click the Open Button.</p> <p>*Obtain the Network Configurator v3 network configuration file from OMRON.</p>	

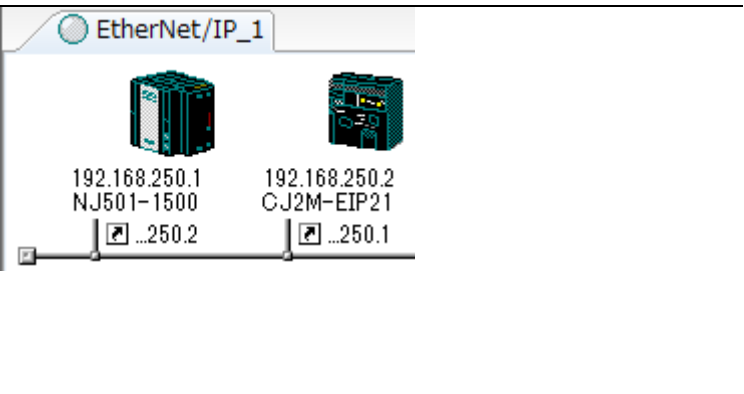
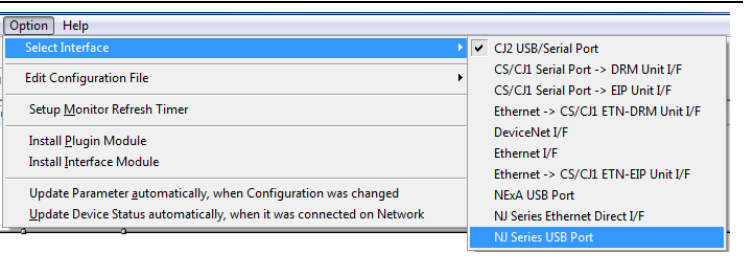
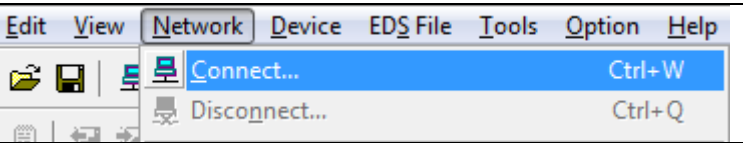
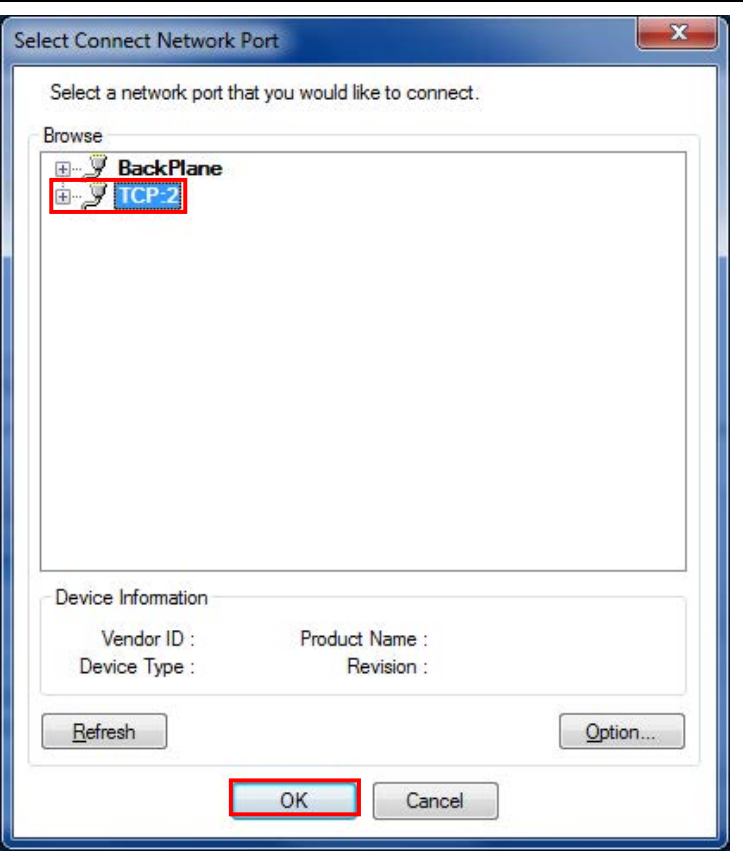
<p>4 The following devices are displayed in the Network Configuration Pane as shown in the right figure. IP address of node 1:192.168.250.1 IP address of node 2:192.168.250.2</p>	
<p>5 Select Select Interface - NJ Series USB Port from the Option Menu.</p>	
<p>6 Select Connect from the Network Menu.</p>	
<p>7 The Select Connect Network Port Dialog Box is displayed. Select TCP:2. Click the OK Button.</p>	

- 8 The Select Connected Network Dialog Box is displayed. Check the contents and click the **OK** Button.

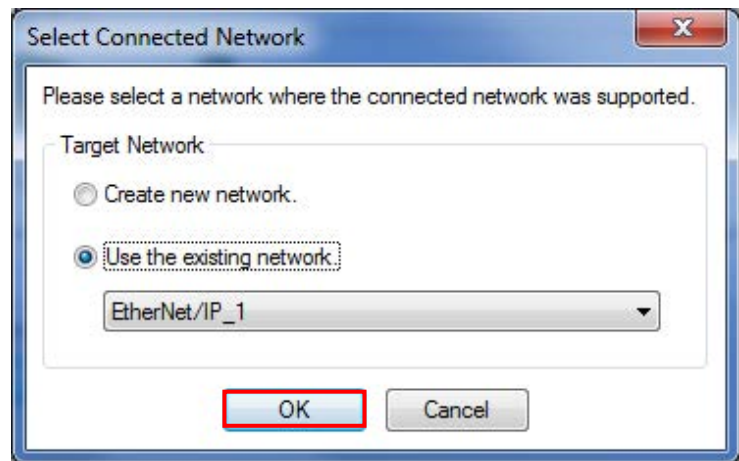

- 9 When an online connection is established normally, the color of the icon on the right figure changes to blue.

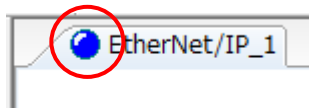

Additional Information

If an online connection cannot be made to the Controller, check the cable connection. Or, return to step 5, check the settings and repeat each step.

For details, refer to *7-2-8 Connecting the Network Configurator to the Network* in *Section 7 Tag Data Link Functions of the NJ-series CPU Unit Built-in EtherNet/IP Port User's Manual* (Cat. No. W506).

7.4.2. Transferring the Tag Data Link Parameters

Transfer the tag data link parameters to the Controller.

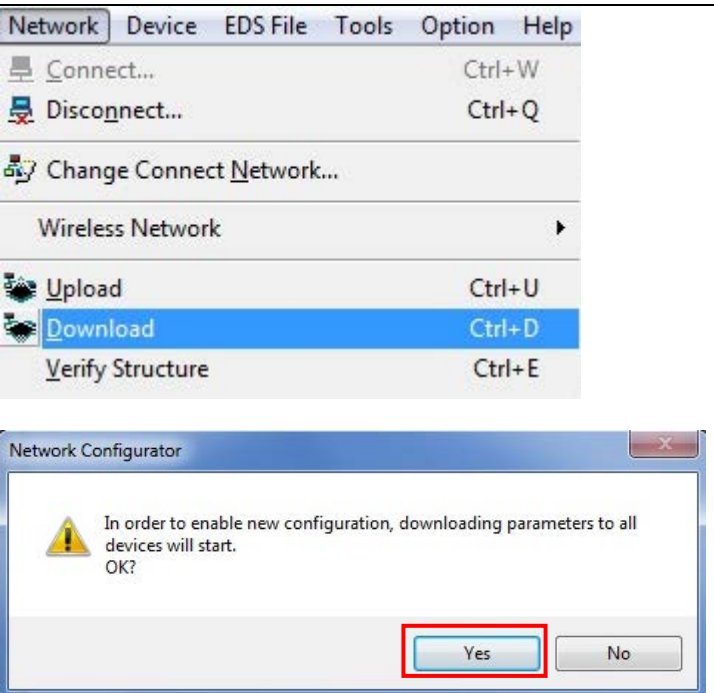
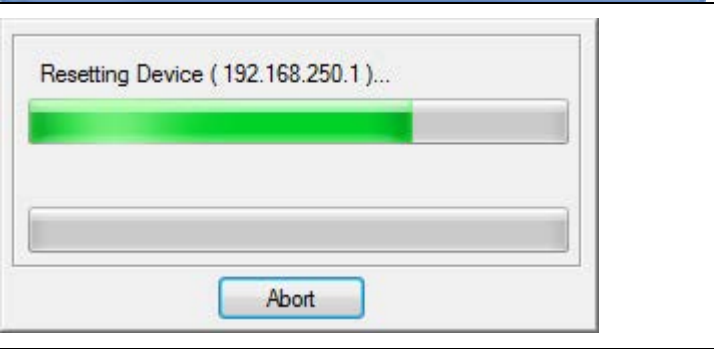
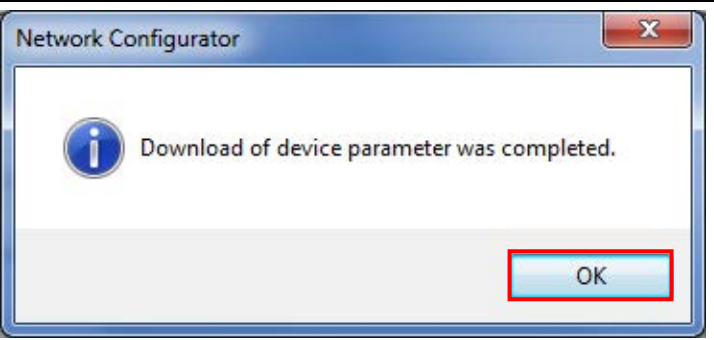
<p>1 Select Download from the Network Menu.</p> <p>The dialog box on the right is displayed. Confirm that there is no problem and click the Yes Button.</p>	 <p>The image shows a software menu with 'Network' selected. The 'Download' option is highlighted in blue. Below the menu, a 'Network Configurator' dialog box is open, displaying a warning icon and the text: 'In order to enable new configuration, downloading parameters to all devices will start. OK?'. The 'Yes' button is highlighted with a red rectangle.</p>
<p>2 Tag data link parameters are downloaded from the Network Configurator to the Controller.</p>	 <p>The image shows a progress dialog box titled 'Resetting Device (192.168.250.1)...'. It features a green progress bar that is approximately 75% full. Below the progress bar is an 'Abort' button.</p>
<p>3 The dialog box on the right is displayed. Check the contents and click the OK Button.</p>	 <p>The image shows the 'Network Configurator' dialog box with an information icon and the text: 'Download of device parameter was completed.'. The 'OK' button is highlighted with a red rectangle.</p>

7.5. Checking the EtherNet/IP Communications

Confirm that the EtherNet/IP tag data links are operated normally.

7.5.1. Checking the Connection Status

Check the connection status of EtherNet/IP.

- 1 Confirm that the tag data links are normally in operation by checking the LED indicators on each device.

- Controller (Built-in EtherNet/IP port)
LED indicators in normal status:
[NET RUN]: Lit green
[NET ERR]: Not lit
[LINK/ACT]: Flashing yellow
(Flashing while packets are being sent and received)

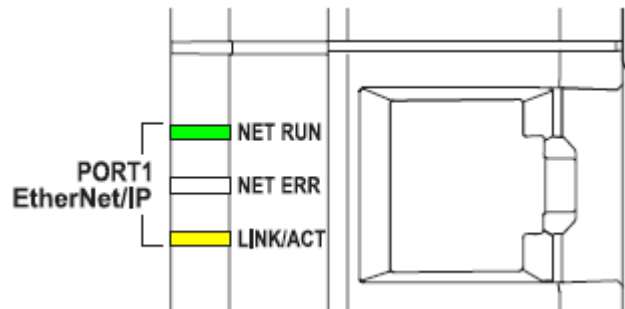

(Controller)

- PLC (EtherNet/IP Unit)
LED indicators in normal status:
[MS]: Lit green
[NS]: Lit green
[COMM]: Lit yellow
[100M] or [10M]: Lit yellow



(EtherNet/IP Unit)

- 2 Confirm that the tag data links are normally in operation by checking the status information on the Device Monitor Window of the Network Configurator.



Right-click the device icon of node 1 on the Network Configuration Pane and select **Monitor**.

3 The dialog box on the right displays the Status 1 Tab Page of the Device Monitor Dialog Box.

When the same items in the right dialog box are selected, the data links are normally in operation.

Click the **Close** Button.

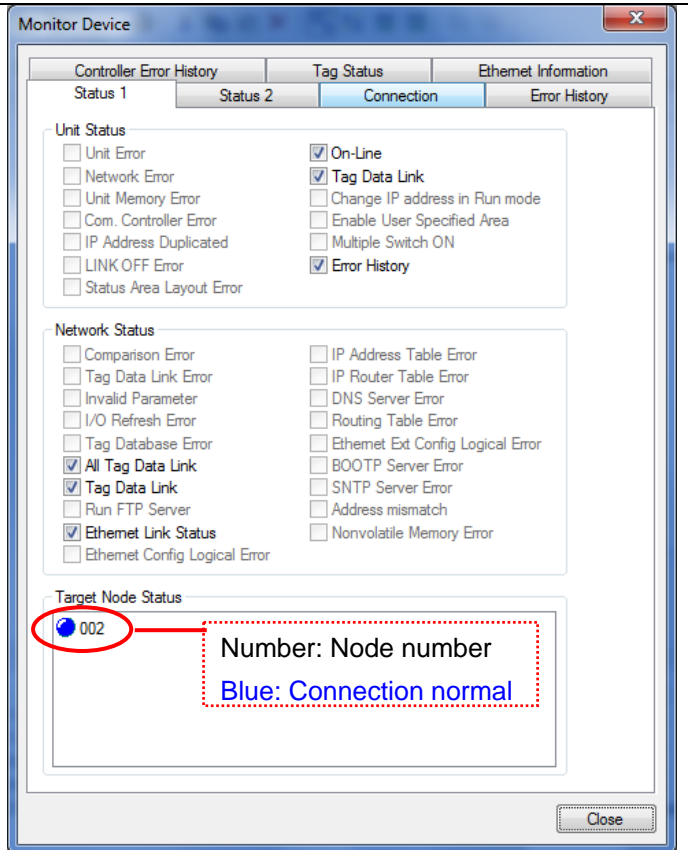

4 Select **Disconnect** from the Network Menu to go offline. The color of the icon on the figure changes from blue. Select **Exit** from the File Menu to exit the Network Configurator.

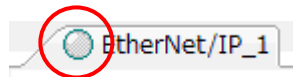

7.5.2. Checking the Data that are Sent and Received

Confirm that the correct data are sent and received.

WARNING

Always confirm safety at the destination node before you transfer a user program, configuration data, setup data, device variables, or values in memory used for CJ-series Units from the Sysmac Studio.

The devices or machines may perform unexpected operation regardless of the operating mode of the CPU Unit.

1	Select Watch Tab Page from the View Menu.																																																													
2	The Watch Window1 Tab Page is displayed in the lower section of the Edit Pane.																																																													
3	The following names are entered in the Watch Window1 Tab Page for monitoring. EIP002_D10100_OUT[0] EIP002_D10100_OUT[1] EIP002_D10000_IN[0] EIP002_D10000_IN[1]																																																													
4	Enter 1234 in the <i>Modify</i> Column of <i>EIP002_D10100_OUT[0]</i> . After entering the value, press the Enter Key. The online value of <i>EIP002_D10100_OUT[0]</i> changes to 1234. Enter 5678 in the <i>Modify</i> Column of <i>EIP002_D10100_OUT[1]</i> in the same way. The online value changes to 5678.	<table border="1" style="width: 100%; border-collapse: collapse; text-align: center;"> <thead> <tr> <th>Name</th> <th>Online value</th> <th>Modify</th> <th>Data type</th> </tr> </thead> <tbody> <tr> <td>EIP002_D10100_OUT[0]</td> <td>0000</td> <td style="border: 2px solid red;">1234</td> <td>WORD</td> </tr> <tr> <td>EIP002_D10100_OUT[1]</td> <td>0000</td> <td></td> <td>WORD</td> </tr> <tr> <td>EIP002_D10000_IN[0]</td> <td>0001</td> <td></td> <td>WORD</td> </tr> <tr> <td>EIP002_D10000_IN[1]</td> <td>0000</td> <td></td> <td>WORD</td> </tr> </tbody> </table> <div style="text-align: center; margin: 5px 0;"> </div> <table border="1" style="width: 100%; border-collapse: collapse; text-align: center;"> <thead> <tr> <th>Name</th> <th>Online value</th> <th>Modify</th> <th>Data type</th> </tr> </thead> <tbody> <tr> <td>EIP002_D10100_OUT[0]</td> <td style="border: 2px solid red;">1234</td> <td style="color: green;">1234</td> <td>WORD</td> </tr> <tr> <td>EIP002_D10100_OUT[1]</td> <td>0000</td> <td></td> <td>WORD</td> </tr> <tr> <td>EIP002_D10000_IN[0]</td> <td>0001</td> <td></td> <td>WORD</td> </tr> <tr> <td>EIP002_D10000_IN[1]</td> <td>0000</td> <td></td> <td>WORD</td> </tr> </tbody> </table> <div style="text-align: center; margin: 5px 0;"> </div> <table border="1" style="width: 100%; border-collapse: collapse; text-align: center;"> <thead> <tr> <th>Name</th> <th>Online value</th> <th>Modify</th> <th>Data type</th> </tr> </thead> <tbody> <tr> <td>EIP002_D10100_OUT[0]</td> <td>1234</td> <td style="color: green;">1234</td> <td>WORD</td> </tr> <tr> <td>EIP002_D10100_OUT[1]</td> <td style="border: 2px solid red;">5678</td> <td style="color: green;">5678</td> <td>WORD</td> </tr> <tr> <td>EIP002_D10000_IN[0]</td> <td>0001</td> <td></td> <td>WORD</td> </tr> <tr> <td>EIP002_D10000_IN[1]</td> <td>0000</td> <td></td> <td>WORD</td> </tr> </tbody> </table>	Name	Online value	Modify	Data type	EIP002_D10100_OUT[0]	0000	1234	WORD	EIP002_D10100_OUT[1]	0000		WORD	EIP002_D10000_IN[0]	0001		WORD	EIP002_D10000_IN[1]	0000		WORD	Name	Online value	Modify	Data type	EIP002_D10100_OUT[0]	1234	1234	WORD	EIP002_D10100_OUT[1]	0000		WORD	EIP002_D10000_IN[0]	0001		WORD	EIP002_D10000_IN[1]	0000		WORD	Name	Online value	Modify	Data type	EIP002_D10100_OUT[0]	1234	1234	WORD	EIP002_D10100_OUT[1]	5678	5678	WORD	EIP002_D10000_IN[0]	0001		WORD	EIP002_D10000_IN[1]	0000		WORD
Name	Online value	Modify	Data type																																																											
EIP002_D10100_OUT[0]	0000	1234	WORD																																																											
EIP002_D10100_OUT[1]	0000		WORD																																																											
EIP002_D10000_IN[0]	0001		WORD																																																											
EIP002_D10000_IN[1]	0000		WORD																																																											
Name	Online value	Modify	Data type																																																											
EIP002_D10100_OUT[0]	1234	1234	WORD																																																											
EIP002_D10100_OUT[1]	0000		WORD																																																											
EIP002_D10000_IN[0]	0001		WORD																																																											
EIP002_D10000_IN[1]	0000		WORD																																																											
Name	Online value	Modify	Data type																																																											
EIP002_D10100_OUT[0]	1234	1234	WORD																																																											
EIP002_D10100_OUT[1]	5678	5678	WORD																																																											
EIP002_D10000_IN[0]	0001		WORD																																																											
EIP002_D10000_IN[1]	0000		WORD																																																											

- 5 Display the CX-Programmer.
Confirm that the PLC is in PROGRAM mode.

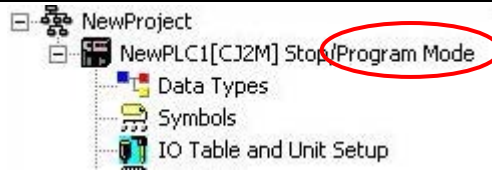

*If the CX-Programmer is online and the PLC is not in PROGRAM mode, change to PROGRAM mode by following Section 7.3.2.

- 6 Select **Edit - Memory** from the PLC Menu.

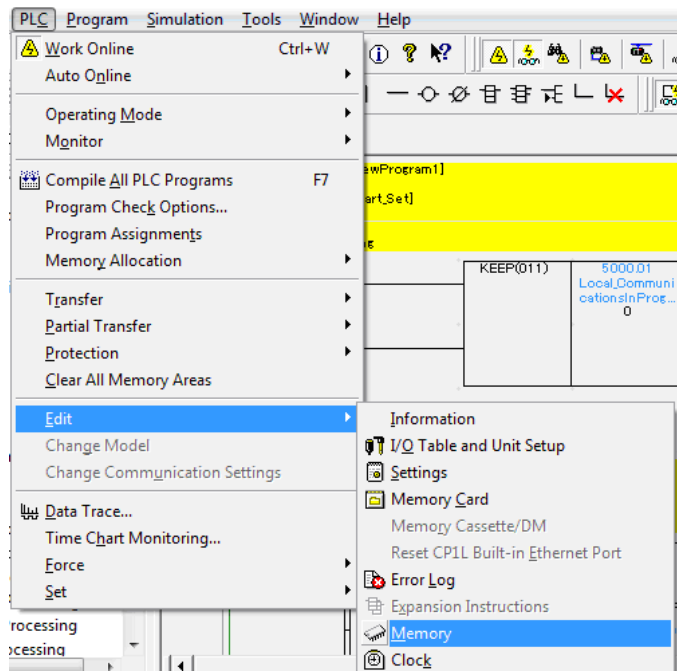

- 7 The PLC Memory Window is displayed.
Double-click **D** from a list in the PLC Memory Window.

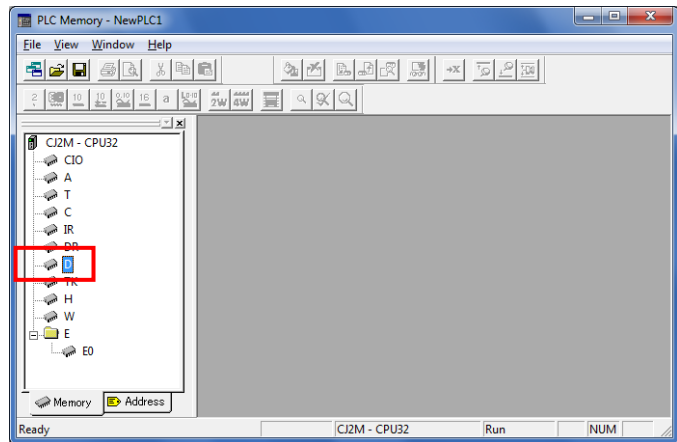

- 8** The D Window is displayed.
Enter *10100* in the *Start Address* Field.

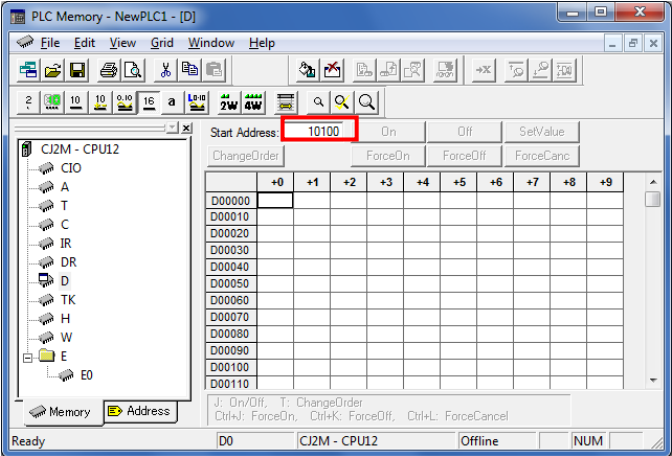
- 9** Select *Display - Hexadecimal* from the View Menu.

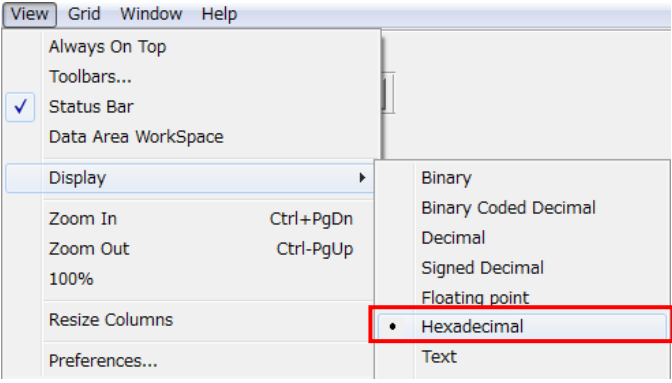

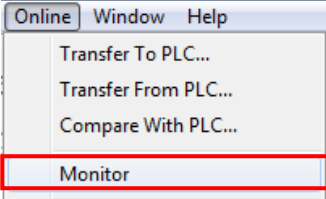
- 10** Select *Monitor* from the Online Menu.

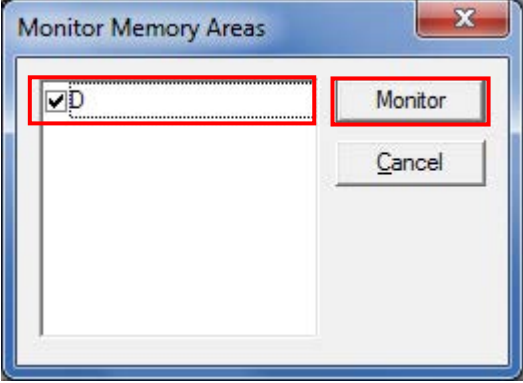
- 11** The Monitor Memory Areas Dialog Box is displayed.
Select the *D* Check Box and click the **Monitor** Button.

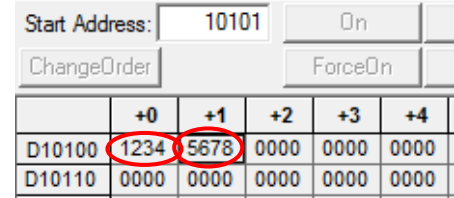
- 12** The values from D10100 are displayed.
You can confirm that D10100 is 1234 and D10101 is 5678 as set in step 4.

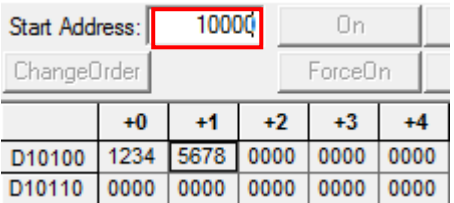

Start Address:	10101					On
ChangeOrder						ForceOn
	+0	+1	+2	+3	+4	
D10100	1234	5678	0000	0000	0000	
D10110	0000	0000	0000	0000	0000	
- 13** Enter *10000* in the *Start Address* Field.



Start Address:	10000					On
ChangeOrder						ForceOn
	+0	+1	+2	+3	+4	
D10100	1234	5678	0000	0000	0000	
D10110	0000	0000	0000	0000	0000	

14 Select *D10000* and click the **SetValue** Button.

Start Address:	10000	On	Off	SetValue					
ChangeOrder		ForceOn	ForceOff	ForceCanc					
	+0	+1	+2	+3	+4	+5	+6	+7	+8
D10000	0000	0000	0000	0000	0000	0000	0000	0000	0000
D10010	0000	0000	0000	0000	0000	0000	0000	0000	0000

15 The Set Value Dialog Box is displayed. Enter *9876* in the *Value* Field.
Click the **OK** Button.

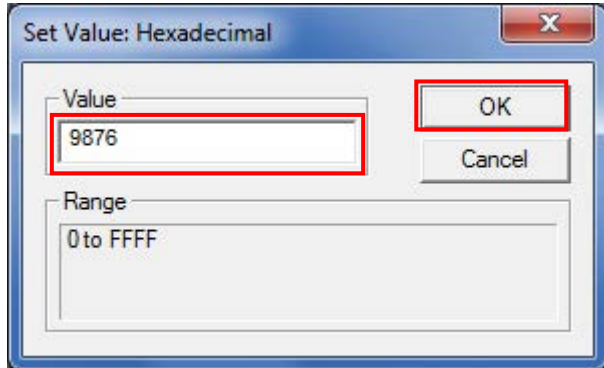

16 Confirm that the value of *D10000* is *9876*.

Start Address:	10000	On			
ChangeOrder		ForceOn			
	+0	+1	+2	+3	+4
D10000	9876	0000	0000	0000	0000
D10010	0000	0000	0000	0000	0000

17 Change *D10001* to *5432* in the same way as steps 14 to 16.

Start Address:	10001	On			
ChangeOrder		ForceOn			
	+0	+1	+2	+3	+4
D10000	9876	5432	0000	0000	0000
D10010	0000	0000	0000	0000	0000

18 Display the Sysmac Studio. Confirm that the online values of *EIP002_D10000_IN[0]* and *EIP002_D10000_IN[1]* are *9876* and *5432*.
You can confirm that the values are the same as the ones set in steps 14 to 17.

Name	Online value	Modify	Data type
EIP002_D10100_OUT[0]	1234	1234	WORD
EIP002_D10100_OUT[1]	5678	5678	WORD
EIP002_D10000_IN[0]	9876		WORD
EIP002_D10000_IN[1]	5432		WORD

8. Initialization Method

This document explains the setting procedure from the factory default setting.

Some settings may not be applicable as described in this document unless you use the devices with the factory default setting.

8.1. Initializing the Controller

To initialize the Controller, it is necessary to initialize the CPU Unit and EtherNet/IP port. Change to PROGRAM Mode before the initialization.

8.1.1. EtherNet/IP port

Delete the connection information and tag information that are set for the EtherNet/IP port. Follow the procedure below to set blank connection information and blank tag information and delete them using the Network Configurator.

(1)Deleting connection information

In the Connections Tab Page of the Edit Device Parameters Dialog Box, move all devices registered in the Register Device List to the Unregister Device List.

If a confirmation dialog box is displayed when you remove devices from the registration list, click the **Yes** Button.

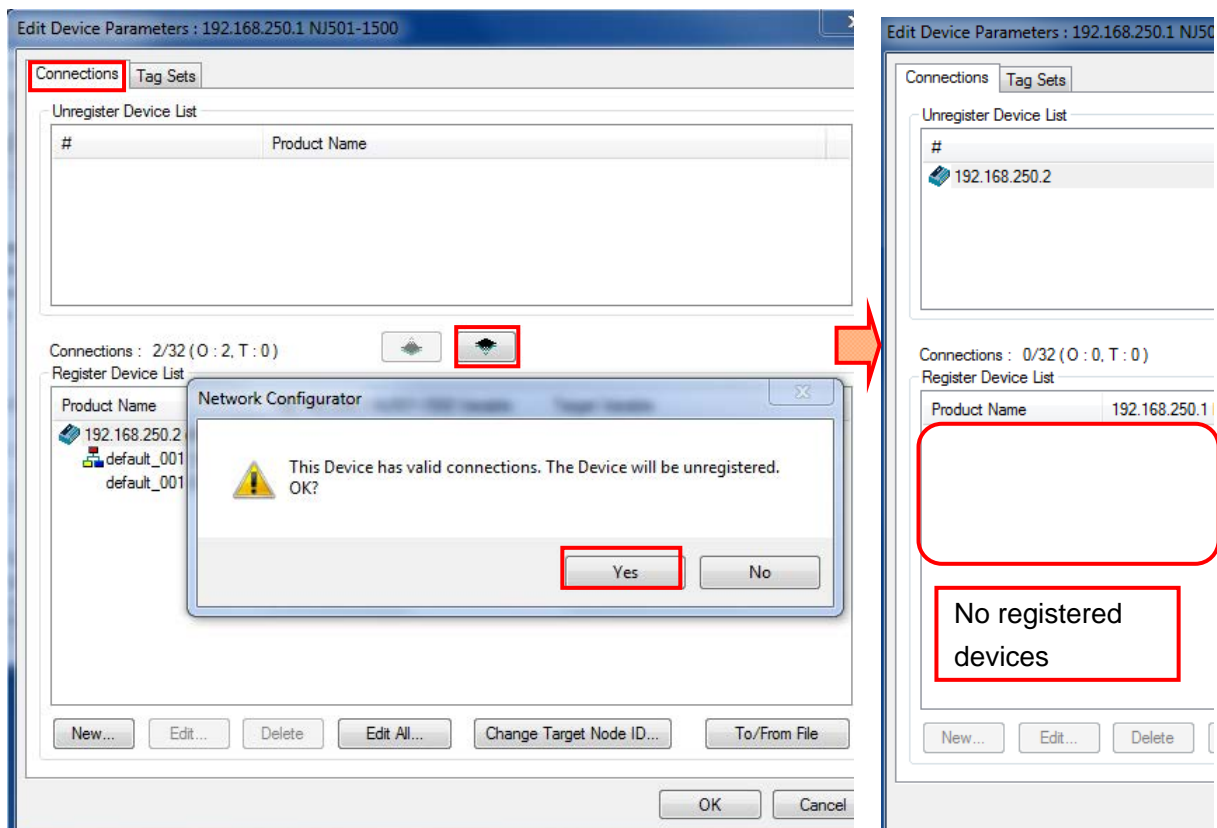

(2)Deleting tag information

In the Tag Sets Tab Page of the Edit Parameters Dialog Box, click the **Delete all of unused Tag Sets** Button.

If a confirmation dialog box is displayed when deleting, click the **Yes** Button.

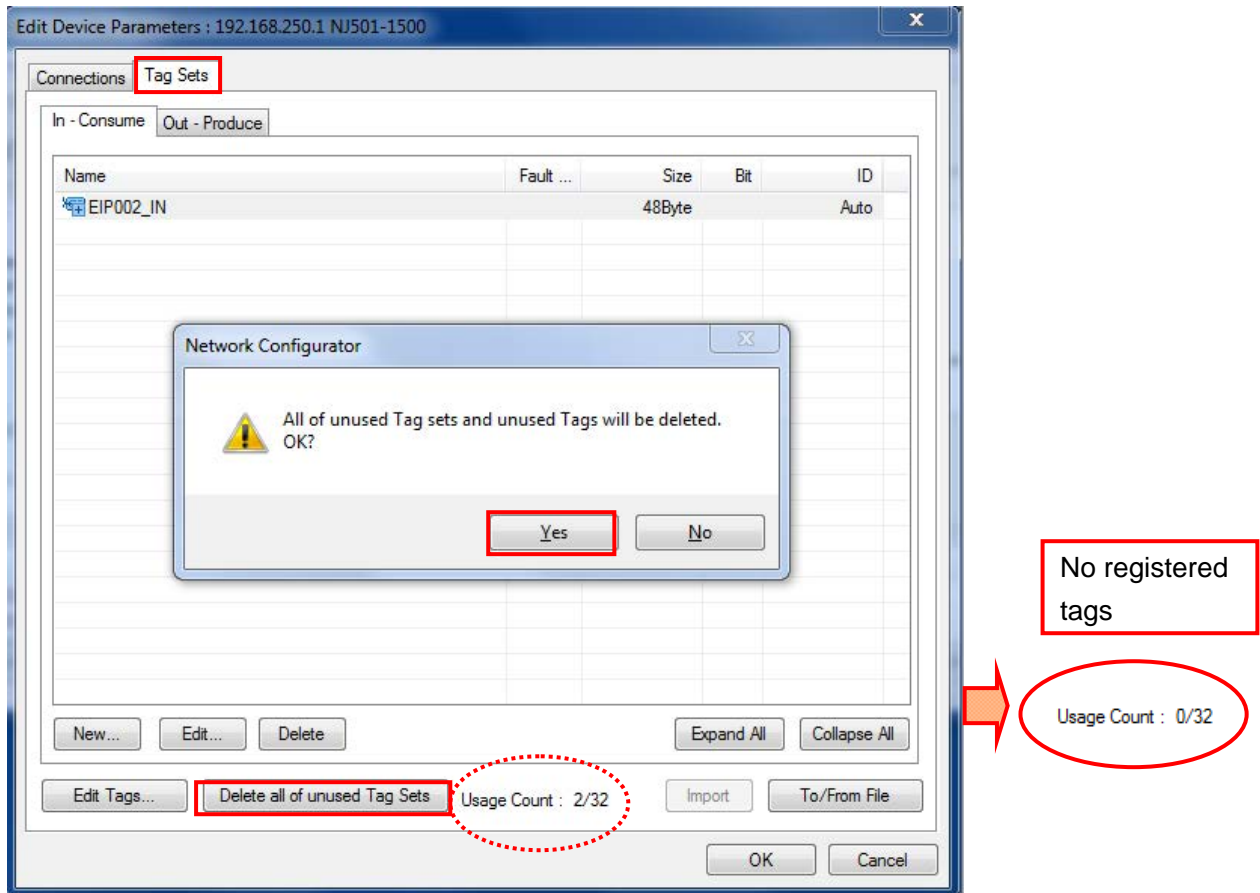

(3)Download

Right-click the Controller and select **Parameter - Download** from the menu that is displayed.

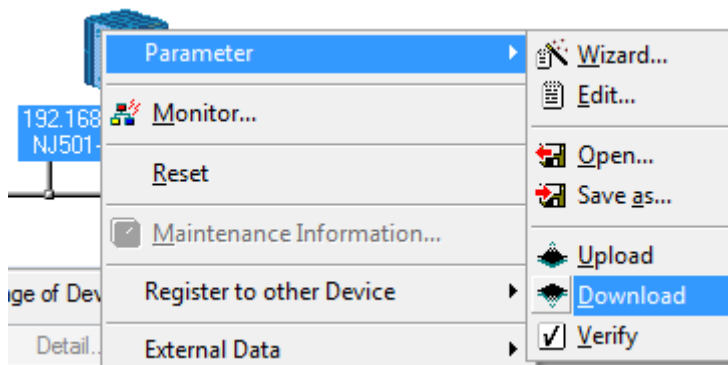

8.1.2. CPU Unit

To initialize the settings of the CPU Unit, select **Clear All Memory** from the Controller Menu of the Sysmac Studio. The Clear All Memory Dialog Box is displayed. Check the contents and click the **OK** Button.

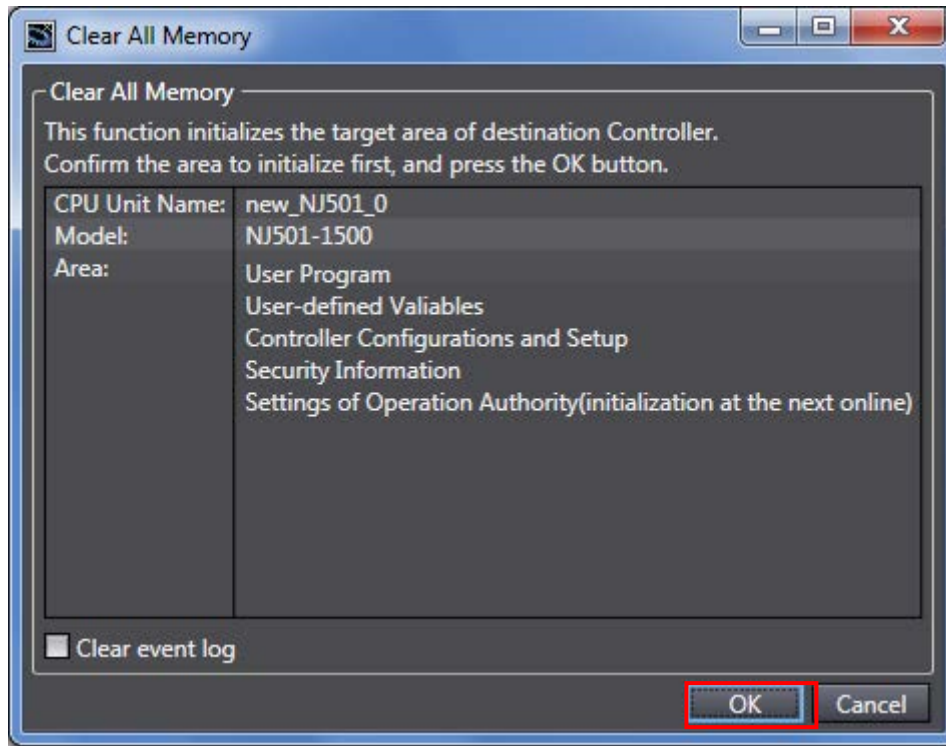

8.2. Initializing the PLC

To initialize the settings of the PLC, it is necessary to initialize the CPU Unit and the EtherNet/IP Unit. Change to PROGRAM mode before the initialization.

8.2.1. EtherNet/IP Unit

(1) Select **Edit - I/O Table and Unit Setup** from the PLC Menu of the CX-Programmer.

Right-click the EtherNet/IP Unit on the PLC IO Table Window and select **Unit Setup** from the menu.

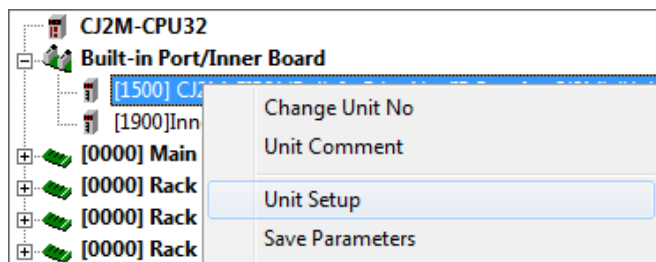

(2) Click the **Restart** Button on the Edit Parameters Dialog Box.

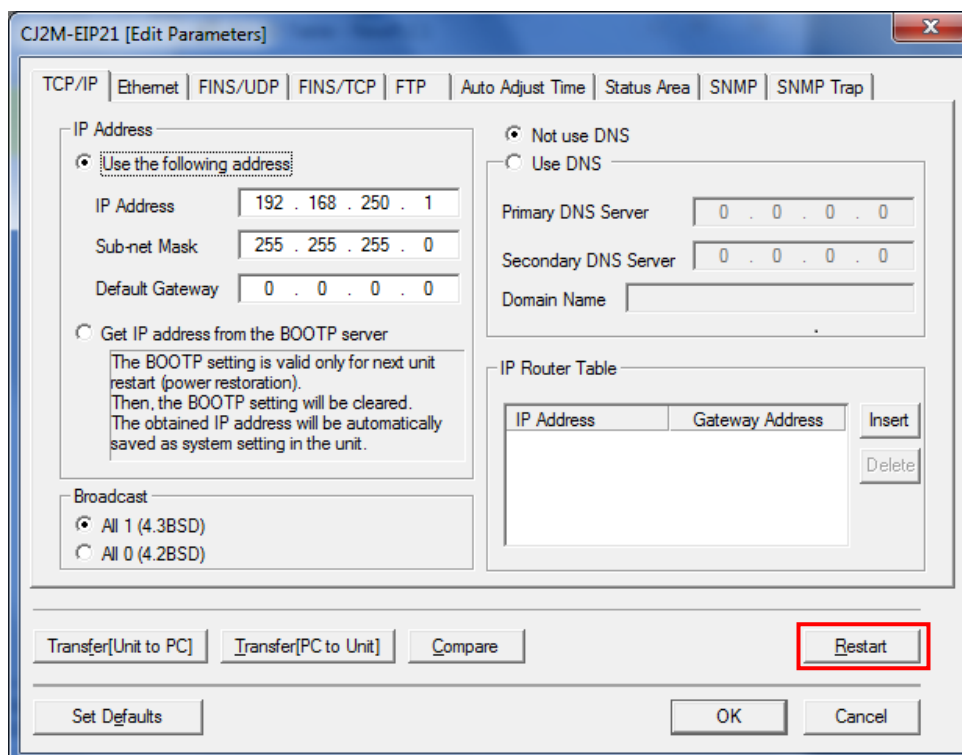

(3) A dialog box is displayed confirming the execution. Confirm that there is no problem and click the **Yes** Button. Then, on the Restart Unit Dialog Box, select the *Return to out-of-box configuration, and then emulate cycling power* Option, and click the **OK** Button. A dialog box is displayed indicating the execution is completed. Check the contents and click the **OK** Button.

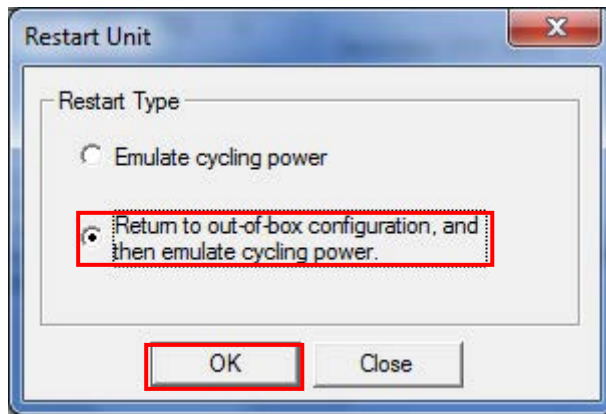

8.2.2. CPU Unit

To initialize the settings of the CPU Unit, select **Clear All Memory Areas** from the PLC Menu of the CX-Programmer. On the Confirm All Memory Area Clear Dialog Box, select the *Initialize* Option and click the **OK** Button.

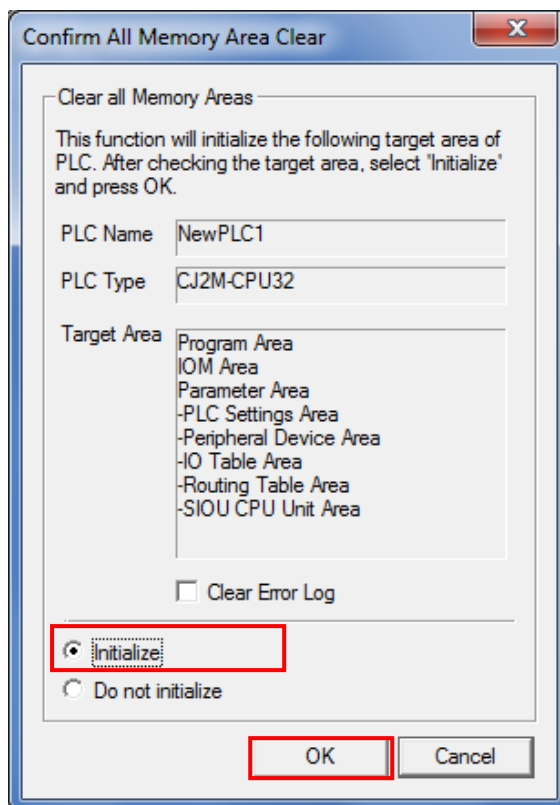

9. Appendix 1 Detailed Settings of the Tag Data Links

This section provides the detailed settings necessary to execute tag data links which are set in this document.

9.1. Global Variable Table

The Controller accesses the data in tag data links as global variables. The following are the settings of the global variables. Use the Sysmac Studio to register a global variable table.

Name	Data type	Retained	Network publish	Destination device allocation
EIP002_D10100_OUT	WORD[10]	Retained	Output	PLC D10100~ (20byte)
EIP002_D10000_IN	WORD[10]	Retained	Input	PLC D10000~ (20byte)



Additional Information

With the Sysmac Studio, two methods can be used to specify an array for a data type. After specifying, (1) is converted to (2) and the data type is always displayed as (2).

(1)WORD[3]/(2)ARRAY[0..2]OF WORD

In this document, the data type is simplified by displaying WORD[3].

(The example above means a WORD data type with three array elements.)

9.2. Relationship between Destination Device and Global Variables

Global variables need to be arranged in offset order of the destination device before setting the tag data link parameters.

The relationship between the memory allocation of the destination device and the global variables is shown below.

■Output area (Controller → PLC)

Offset	Destination device data	Global variable	Data type	Retained
+0 to +9	PLC D10100 onwards (20byte)	EIP002_D10100_OUT	WORD[10]	Retained

■Input area (Controller ← PLC)

Offset	Destination device data	Global variable	Data type	Retained
+0 to +9	PLC D10000 onwards (20byte)	EIP002_D10000_IN	WORD[10]	Retained

9.3. Associating the Tag Data Links

Tag data link parameters are required to perform tag data links with a destination device. Follow the procedures below to associate the tag data links.

- (1) Use the Sysmac Studio to define the global variables to publish on the network. Store the created global variables in a CSV file to use in the Network Configurator.
- (2) Read the CSV file (tag list) created in step 1 to the Network Configurator.
- (3) Make a single tag set that includes the tag lists.
- (4) Link the tag set with the destination device information and create tag data link parameters.

The numbers shown in the tables below correspond to the steps above.

■ Output area (Controller → PLC)

Controller setting (Set with Sysmac Studio.)		Data link table setting (Set with Network Configurator.)		Destination device information	
(1)			Tag set: EIP002_OUT	20byte (4)	← D10100-[20Byte]
Global variable		(3)	Tag list		*Refer to 9.2 for details.
EIP002_D1010 0_OUT	WORD [10]	→ (2)	EIP002_D10 100_OUT	(20byte)	

■ Input area (Controller ← PLC)

Controller setting (Set with Sysmac Studio.)		Data link table setting (Set with Network Configurator.)		Destination device information	
(1)			Tag set: EIP002_IN	20byte (4)	← D10000-[20Byte]
Global variable		(3)	Tag list		*Refer to 9.2 for details.
EIP002_D1000 0_IN	WORD [10]	→ (2)	EIP002_D10 000_IN	(20byte)	

10. Appendix 2 Setting the Tag Data Links Using the Software

This section describes the procedure for setting the Controller without the configuration files (Procedure for setting parameters from the beginning).

You can also refer to this section when you want to change the parameters of the configuration files.

10.1. Overview of Setting Tag Data Links

The following is the relationship between the processes to operate the tag data links using the "procedure for setting parameters from the beginning".

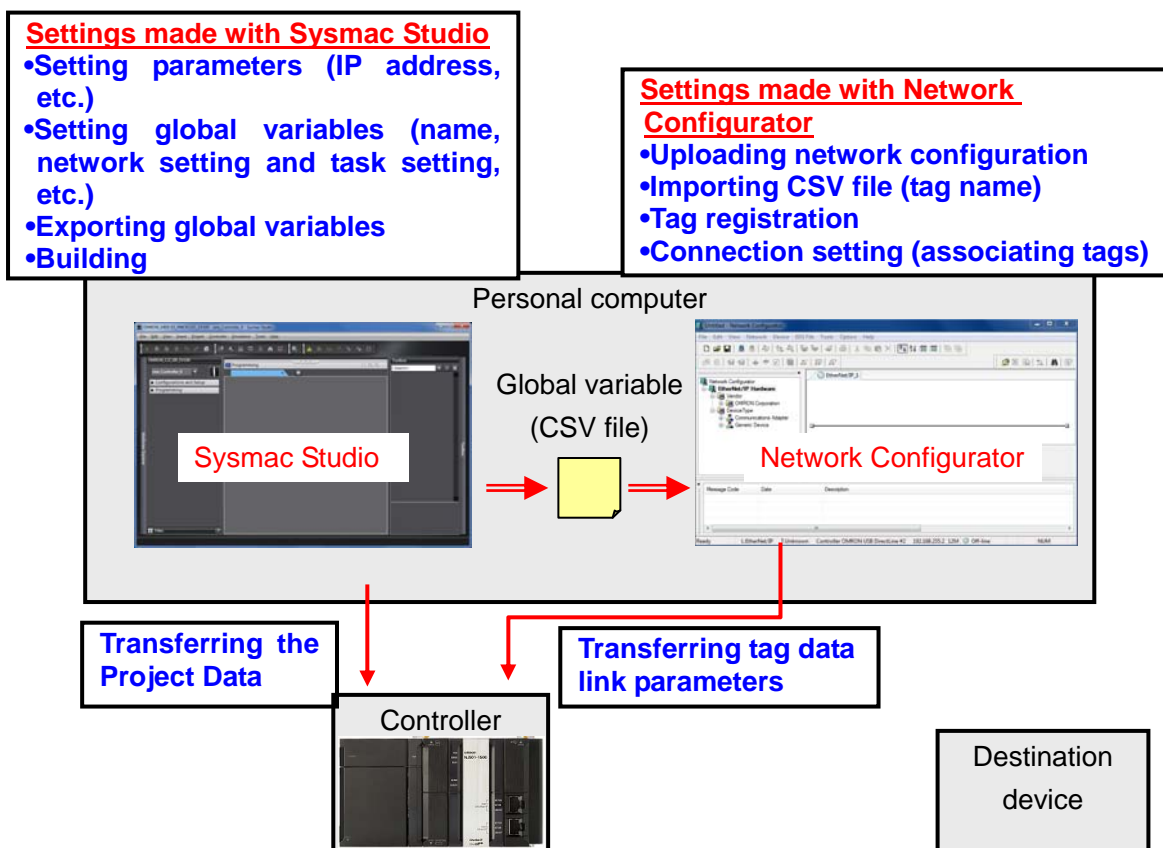

10.2. Work Flow of "Procedure for Setting Parameters from the Beginning"

Take the following steps to make the tag data link settings for EtherNet/IP using the "procedure for setting parameters from the beginning"

This section describes the detailed procedures for 10.3. Setting Up the Controller Using the Software and 10.4. Setting Up the Network Using the Software (in red frames below).

The procedures for 7.3 Setting Up the PLC and 7.6 Checking the EtherNet/IP Communications" are the same as the "procedure for using the configuration files". Refer to the procedures in Section 7.

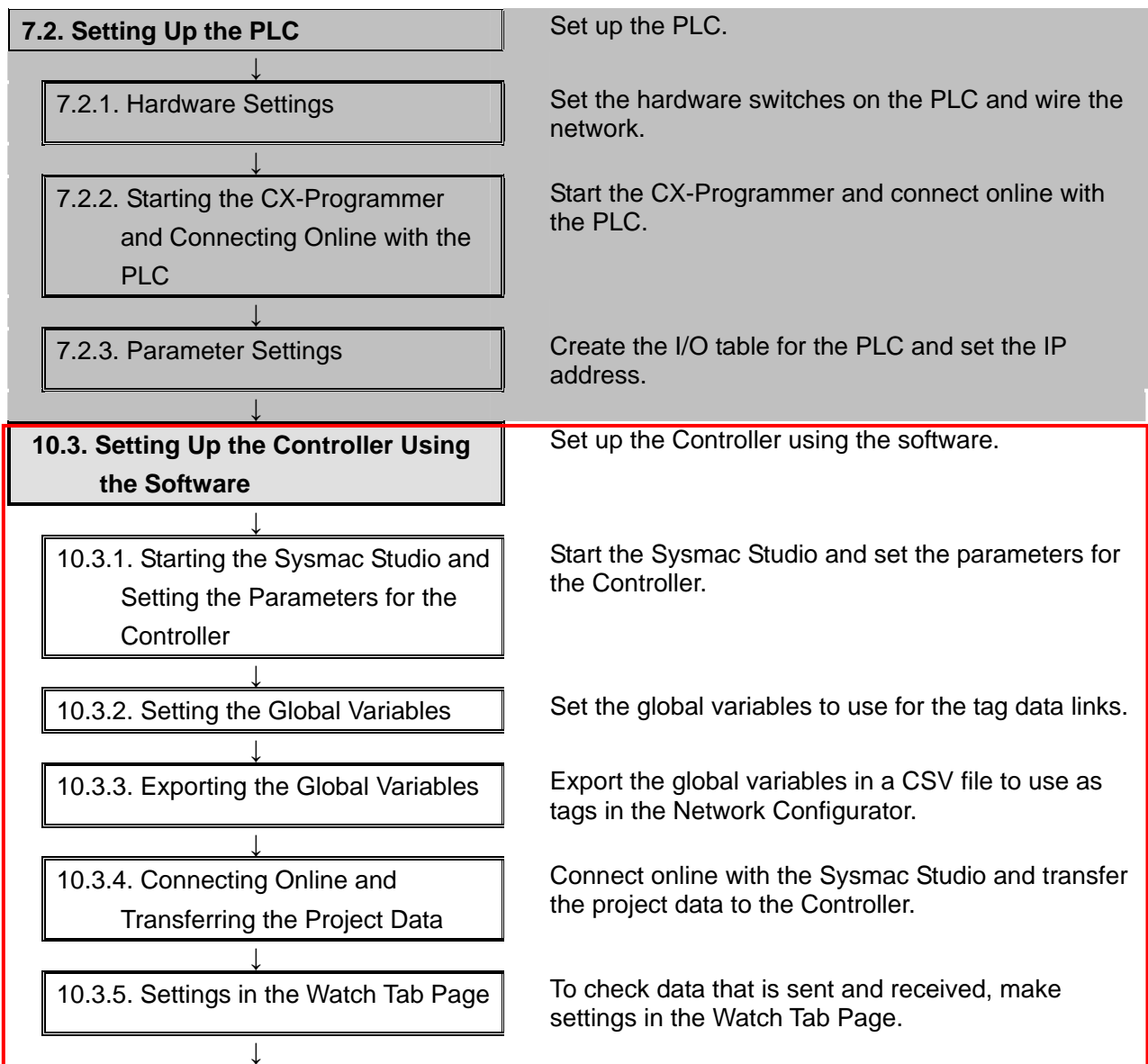

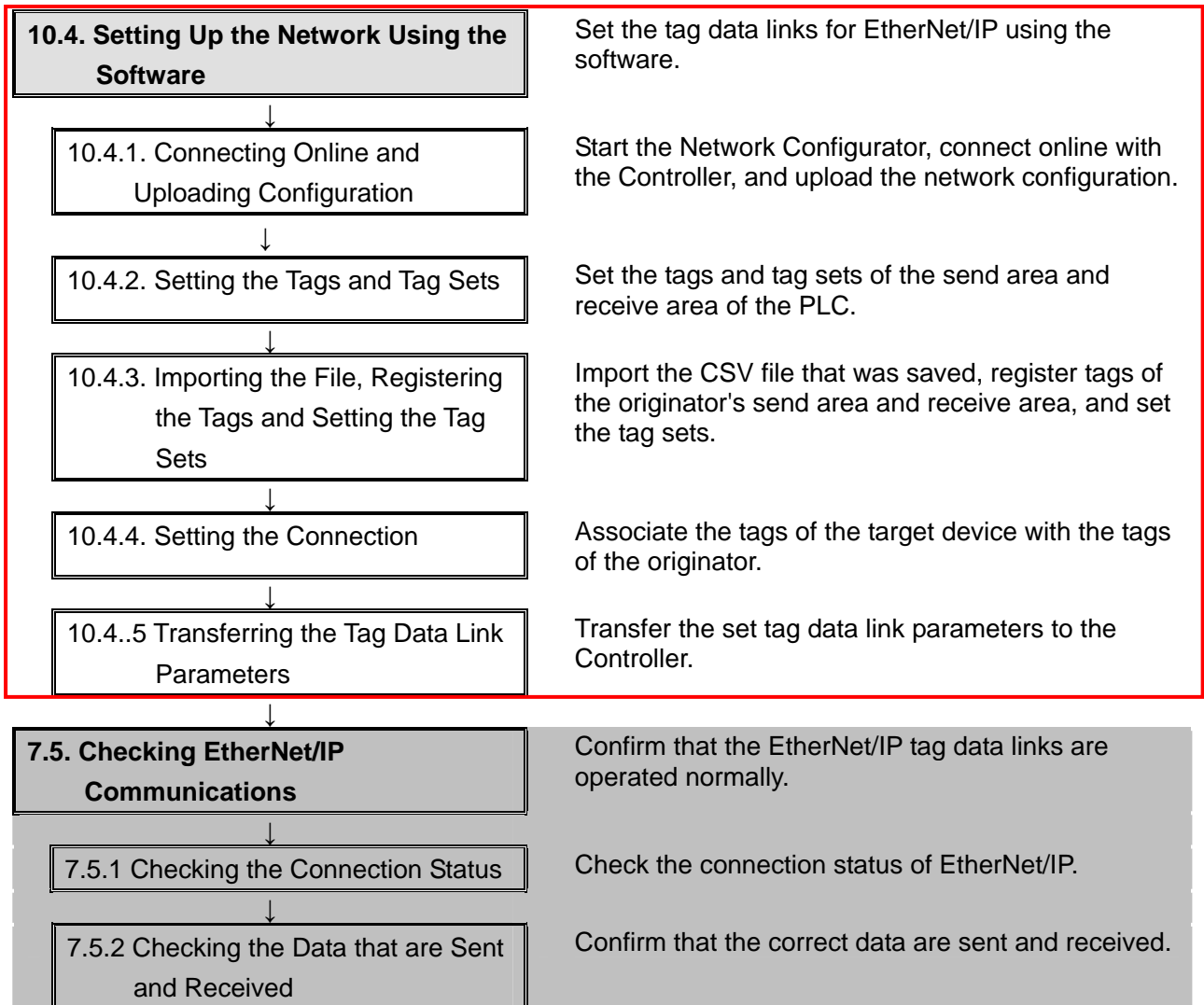

10.3. Setting Up the Controller without the Configuration Files

Set up the Controller using the software.

10.3.1. Starting the Sysmac Studio and Setting the Parameters for the Controller

Start the Sysmac Studio and set the parameters for the Controller.

Install the Sysmac Studio and USB driver in the personal computer beforehand.

- 1 Connect the LAN cable and the USB cable to the Controller, and turn ON the power supply to the Controller.

*For details, refer to step 1 of 7.3.1. Starting the Sysmac Studio and Importing the Project File.

- 2 Start the Sysmac Studio.
Click the **New Project** Button.

*If a confirmation dialog box for an access right is displayed at start, select to start.

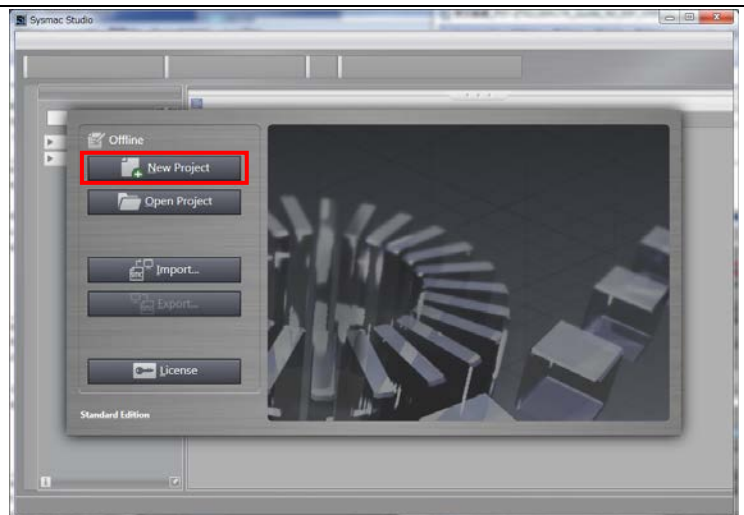

3 The Project Properties Dialog Box is displayed.

*In this document, New Project is set as the project name.

Confirm that Category and Device that you use are set in the *Select Device* Field.

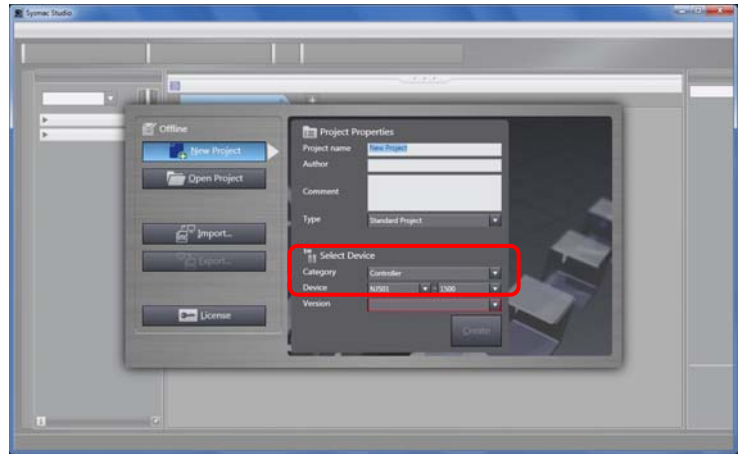

Select version **1.05** from the pull-down list of Version.

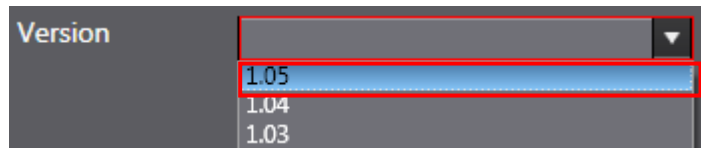

*Although 1.05 is selected in this document, select the version you actually use.

4 Click the **Create** Button.

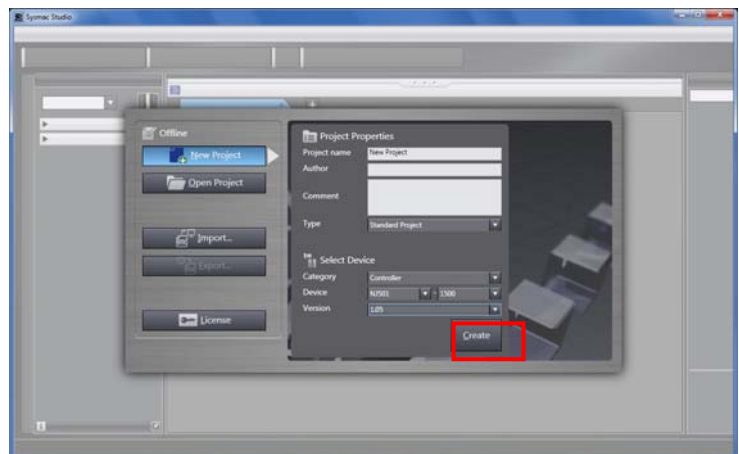

5 The New Project is displayed. The left pane is called Multiview Explorer, the right pane is called Toolbox and the middle pane is called Edit Pane.

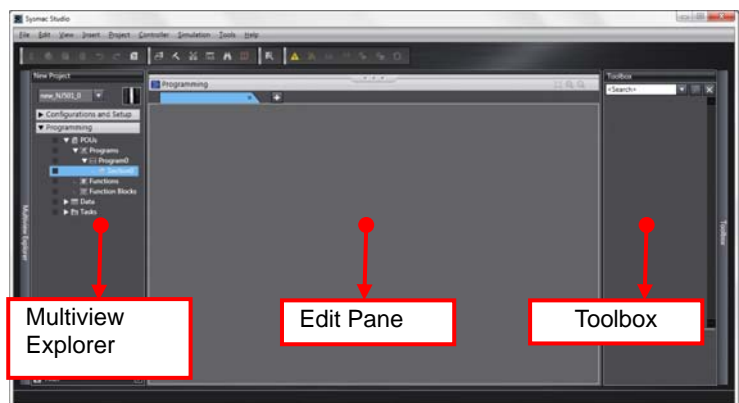

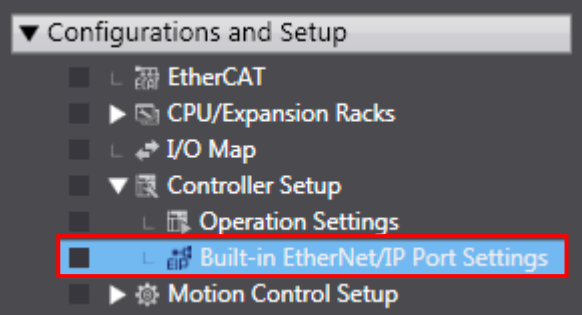
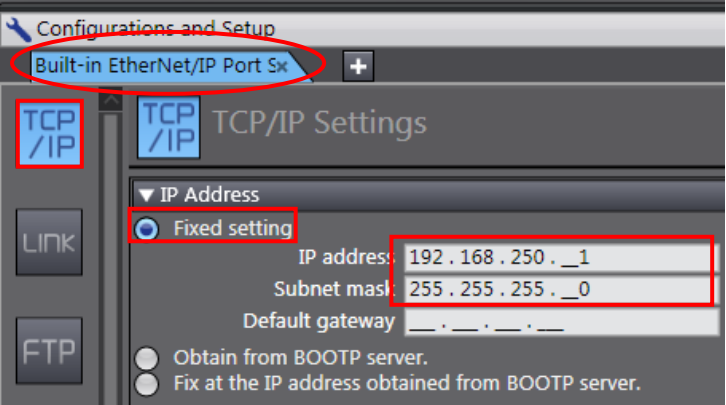
<p>6 Double-click Built-in EtherNet/IP Port Settings under Configurations and Setup - Controller Setup in the Multiview Explorer.</p>	
<p>7 The Built-in EtherNet/IP Port Settings Tab Page is displayed in the Edit Pane. Click the TCP/IP Setting Button, select the <i>Fixed Setting</i> Check Box in the <i>IP Address</i> Field, and make the following settings. IP address: 192.168.250.1 Subnet mask: 255.255.255.0</p>	

10.3.2. Setting the Global Variables

Set the global variables to use for the tag data links.

1 Double-click **Global Variables** under **Programming - Data** in the Multiview Explorer.

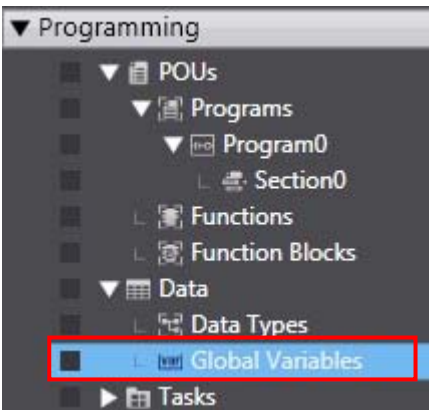

2 The Global Variables Tab Page is displayed in the Edit Pane.

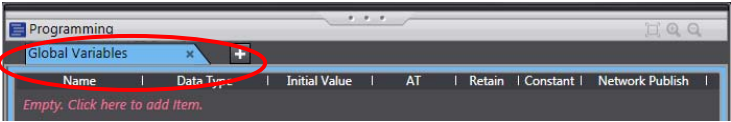

Click a column under the *Name* Column to enter a new variable.



Enter *EIP002_D10100_OUT* in the *Name* Column.

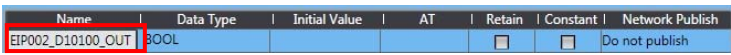

Enter *WORD[10]* in the *Data Type* Column.

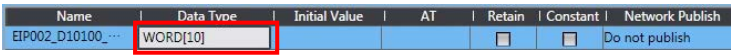

*After entering, the value changes to *ARRAY[0..9] OF WORD* as shown on the right.



Select the *Retain* Check Box to retain the value.

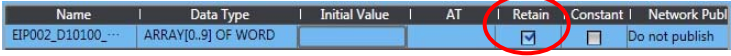

Select **Output** from the Network Publish Menu.

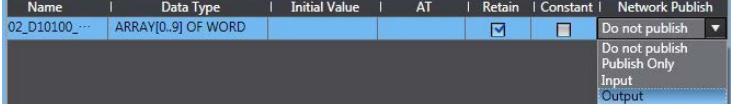
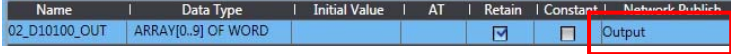

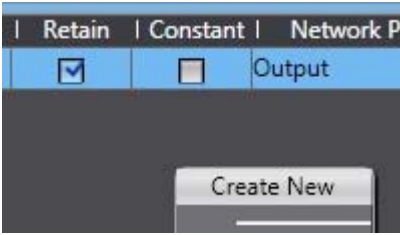

- 3 After entering, right-click and select **Create New** from the menu.

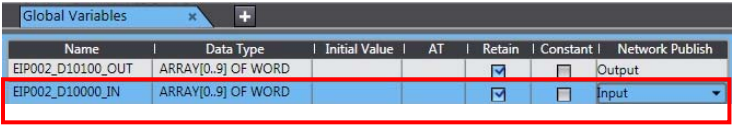
- 4 Enter the following data in the new columns in the same way as steps 2 and 3.

 - Name: EIP002_D10000_IN
 - Data type: WORD[10]
 - Retained: Retained
 - Network Publish: Input

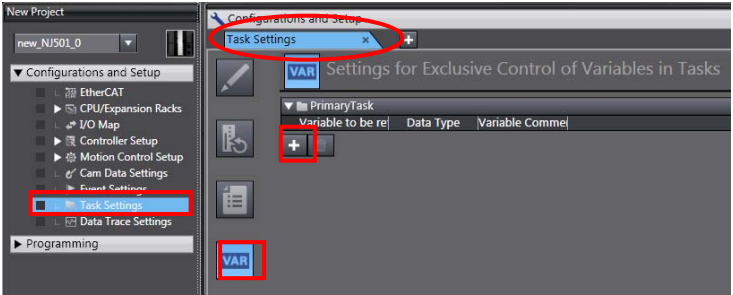
Name	Data Type	Initial Value	AT	Retain	Constant	Network Publish
EIP002_D10100_OUT	ARRAY[0..9] OF WORD			<input checked="" type="checkbox"/>	<input type="checkbox"/>	Output
EIP002_D10000_IN	ARRAY[0..9] OF WORD			<input checked="" type="checkbox"/>	<input type="checkbox"/>	Input
- 5 Double-click **Task Settings** under **Configurations and Setup** in the Multiview Explorer. The Task Settings Tab Page is displayed in the Edit Pane. Click the **Settings for Exclusive Control Variables in Tasks** Button. Click the **+** Button.

- 6 Click the Down Button under Variable to be refreshed. The variables set in steps 2 to 4 are displayed. Select *EIP002_D10100_OUT*.

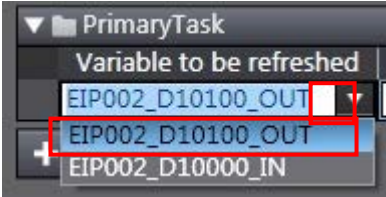
- 8 Click the **+** Button and select a variable to be refreshed. *The data types are displayed automatically, and you do not have to set them.

Add all variables set in step 4 as shown in the right figure.

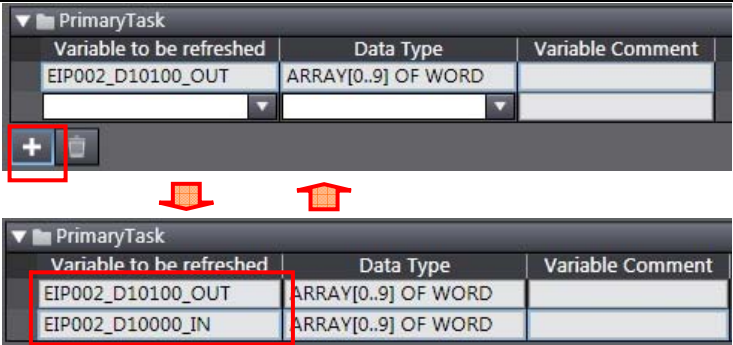

Variable to be refreshed	Data Type	Variable Comment
EIP002_D10100_OUT	ARRAY[0..9] OF WORD	

Variable to be refreshed	Data Type	Variable Comment
EIP002_D10100_OUT	ARRAY[0..9] OF WORD	
EIP002_D10000_IN	ARRAY[0..9] OF WORD	

10.3.3. Exporting the Global Variables

Export the global variables in a CSV file to use as tags in the Network Configurator.

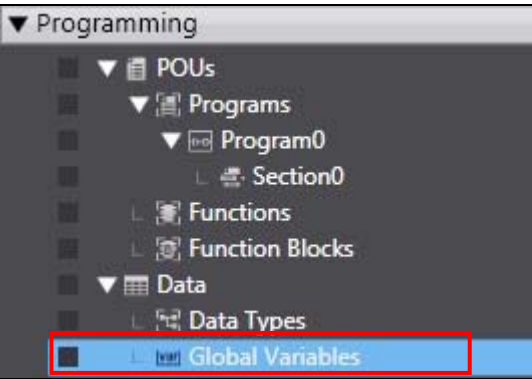
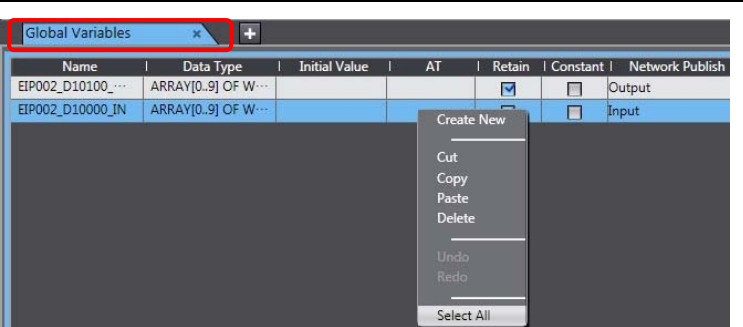
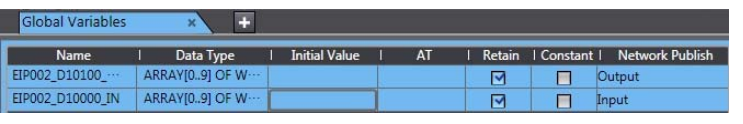
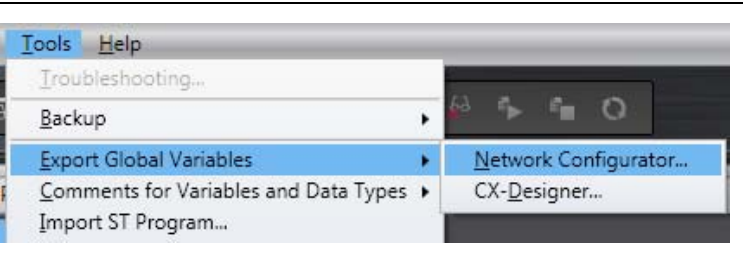
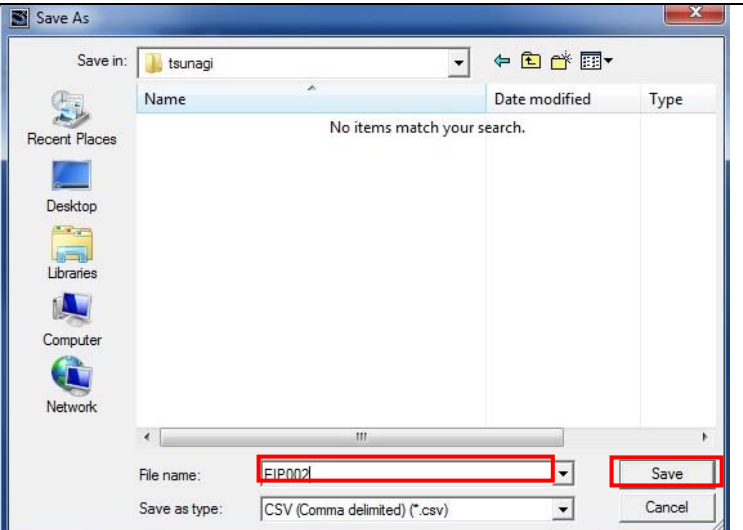
<p>1 Double-click Global Variables under Programming - Data in the Multiview Explorer.</p>	
<p>2 The Global Variables Tab Page is displayed in the Edit Pane. Right-click on the pane and Select Select All.</p> <p>All the selected variables are highlighted.</p>	 <p style="text-align: center;">↓</p> 
<p>3 Select Export Global Variables - Network Configurator from the Tools Menu.</p>	
<p>4 The Save As Dialog Box is displayed. Enter <i>EIP002</i> in the <i>File name</i> Field. Click the Save Button.</p>	

10.3.4. Connecting Online and Transferring the Project Data

Connect online with the Sysmac Studio and transfer the project data to the Controller.

WARNING

Always confirm safety at the destination node before you transfer a user program, configuration data, setup data, device variables, or values in memory used for CJ-series Units from the Sysmac Studio.

The devices or machines may perform unexpected operation regardless of the operating mode of the CPU Unit.

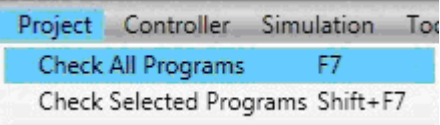
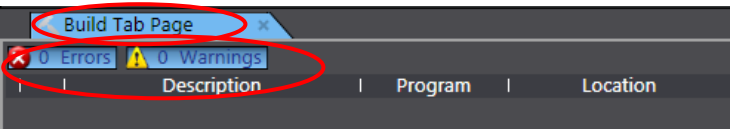
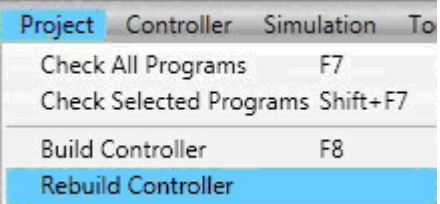
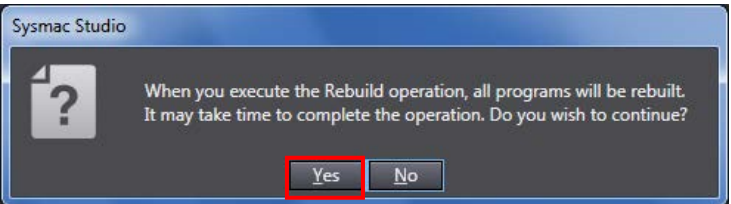
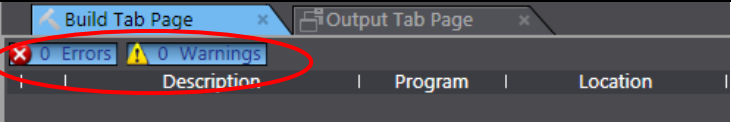
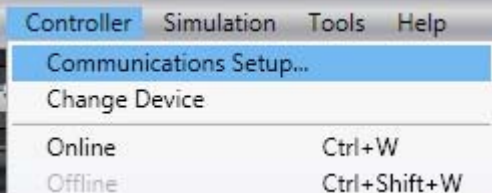
1	Select Check All Programs from the Project Menu.	
2	The Build Tab Page is displayed in the Edit Pane. Confirm that "0 Errors" and "0 Warnings" are displayed.	
3	Select Rebuild Controller from the Project Menu.	
4	A confirmation dialog box is displayed. Check the contents and click the Yes Button.	
5	Confirm that "0 Errors" and "0 Warnings" are displayed in the Build Tab Page.	
6	Select Communications Setup from the Controller Menu.	

7 The Communications Setup Dialog Box is displayed. Select the *Direct connection via USB* Option for Connection Type.

Click the **OK** Button.

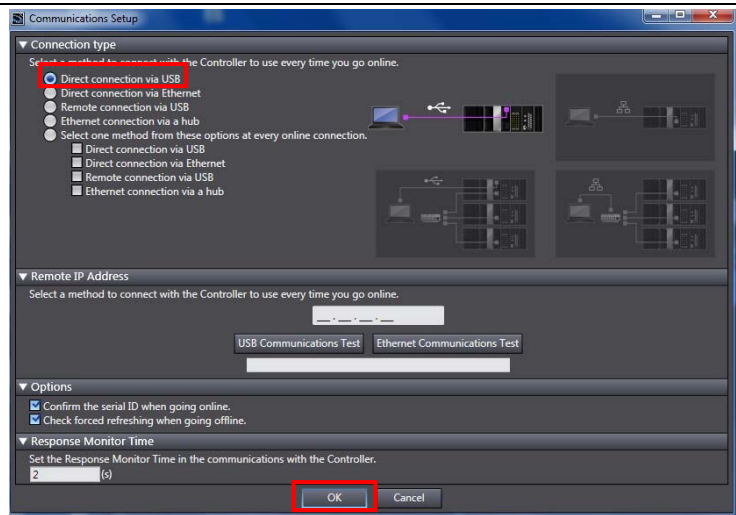

8 Select **Online** from the Controller Menu. A confirmation dialog box is displayed. Check the contents and click the **Yes** Button.

*The displayed dialog box depends on the status of the Controller used. Check the contents and click the **Yes** Button to proceed with the processing.

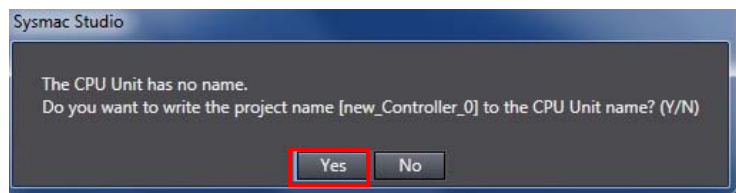
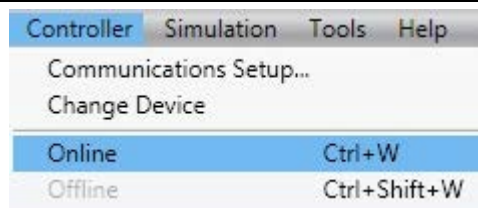

9 When an online connection is established, a yellow bar is displayed on the top of the Edit Pane.

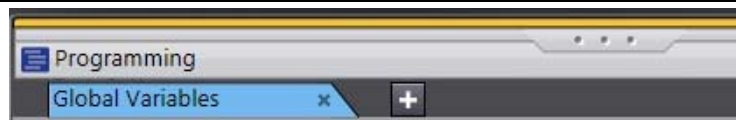

Additional Information

For details on online connections to a Controller, refer to *Section 5 Online Connections to a Controller* of the *Sysmac Studio Version 1 Operation Manual* (Cat. No. W504).

10 Select **Synchronization** from the Controller Menu.



11 The Synchronization Dialog Box is displayed.

Confirm that the data to transfer (NJ501 in the right dialog box) is selected. Then, click the **Transfer To Controller** Button.

*After executing Transfer To Controller, the Sysmac Studio data is transferred to the Controller and the data are compared.

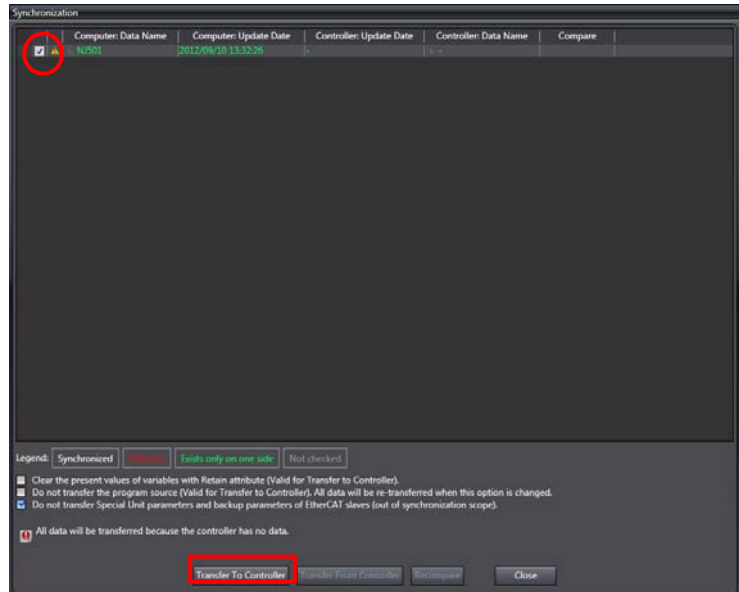

12 A confirmation dialog box is displayed. Confirm that there is no problem and click the **Yes** Button.

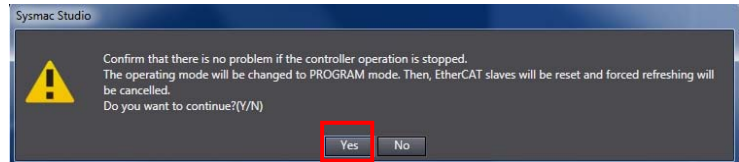

A screen stating "Synchronizing" is displayed.



A confirmation dialog box is displayed. Confirm that there is no problem and click the **No** Button.

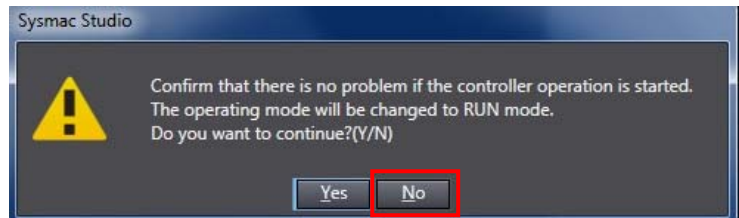

*Be sure not to return it to "RUN mode".

- 13 Confirm that the synchronized data is displayed with the color specified by "Synchronized" and that a message is displayed stating "The synchronization process successfully finished". If there is no problem, click the **Close** Button.

*A message stating "The synchronization process successfully finished" is displayed if the Sysmac Studio project data and the data in the Controller match.

*If the synchronization fails, check the wiring and repeat from step 1.

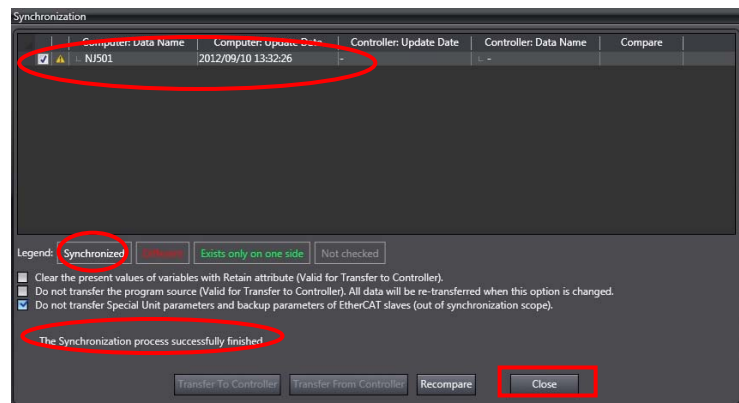

10.3.5. Settings in the Watch Tab Page

To check data that is sent and received, make settings in the Watch Tab Page.

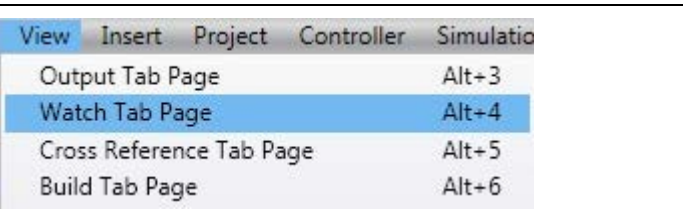
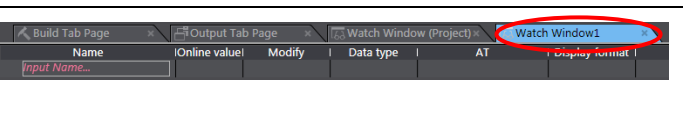
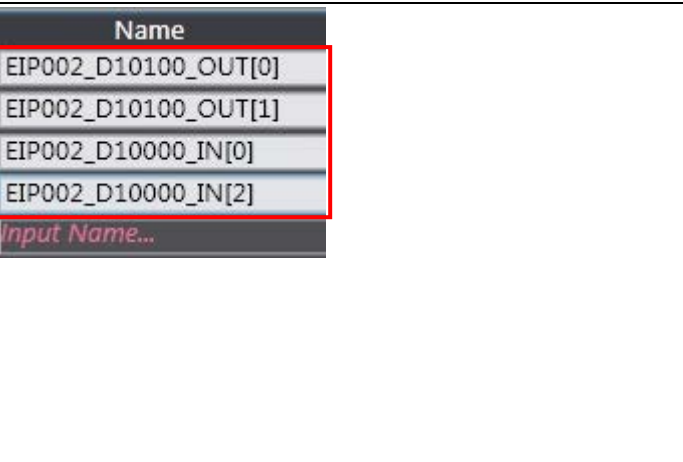
<p>1</p>	<p>Select Watch Tab Page from the View Menu.</p>	
<p>2</p>	<p>The Watch Window1 Tab Page is displayed in the lower section of the Edit Pane.</p>	
<p>3</p>	<p>Enter the following names in the Watch1 Tab Page for monitoring. To enter a new name, click a column stating Input Name.</p> <p>EIP002_D10100_OUT[0] EIP002_D10100_OUT[1] EIP002_D10000_IN[0] EIP002_D10000_IN[1]</p> <p>*You will use the settings in 7.5.2. Checking the Data That are Sent and Received.</p>	

10.4. Setting Up the Network Using the Software

Set the tag data links for EtherNet/IP using the software.

10.4.1. Connecting Online and Uploading Configuration

Start the Network Configurator, connect online with the Controller, and upload the network configuration.



Precautions for Correct Use

Please confirm that the LAN cable is connected before performing the following procedure. When it is not connected, turn OFF the power supply to each device and then connect the LAN cable.

<p>1 Start the Network Configurator.</p>	
<p>2 Select Select Interface - NJ Series USB Port from the Option Menu.</p>	
<p>3 Select Connect from the Network Menu.</p>	

- 4 The Select Connect Network Port Dialog Box is displayed. Select *TCP:2*. Click the **OK** Button.

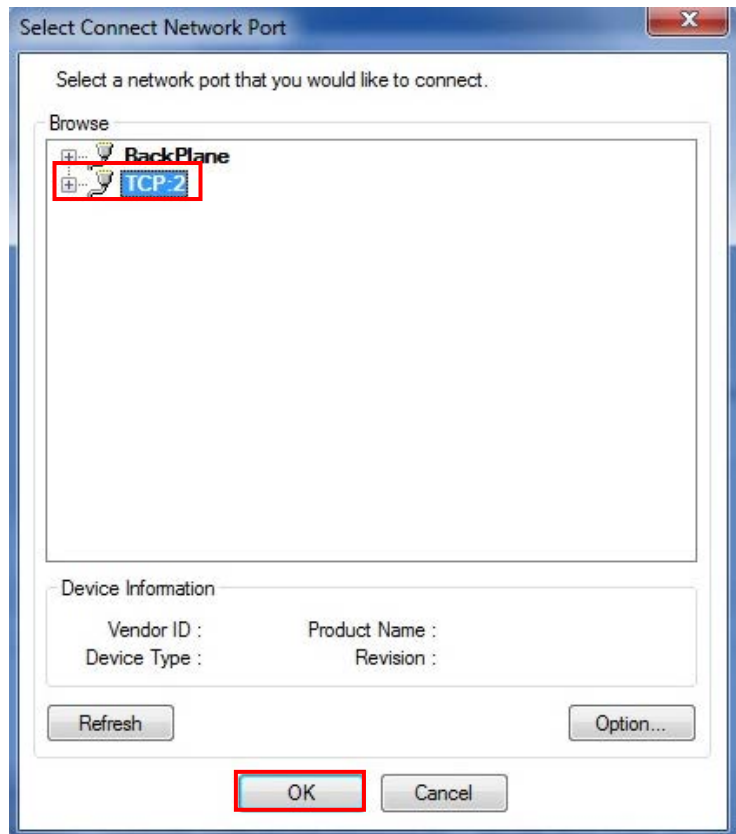

- 5 The Select Connected Network Dialog Box is displayed. Check the contents and click the **OK** Button.

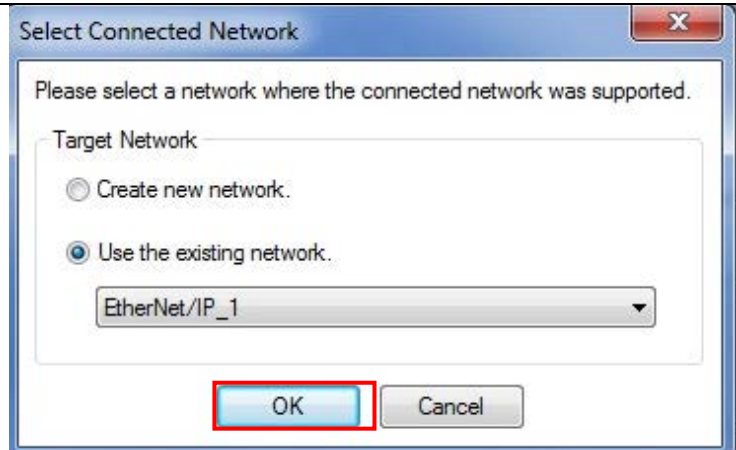

- 6 When an online connection is established normally, the color of the icon on the right figure changes to blue.

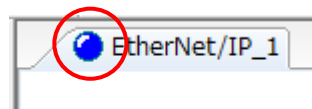



Additional Information

If an online connection cannot be made to the Controller, check the cable connection. Or, return to step 1, check the settings and repeat each step.

For details, refer to 7-2-8 *Connecting the Network Configurator to the Network* in Section 7 *Tag Data Link Functions* of the *NJ-series CPU Unit Built-in EtherNet/IP™ Port User's Manual* (Cat. No. W506).

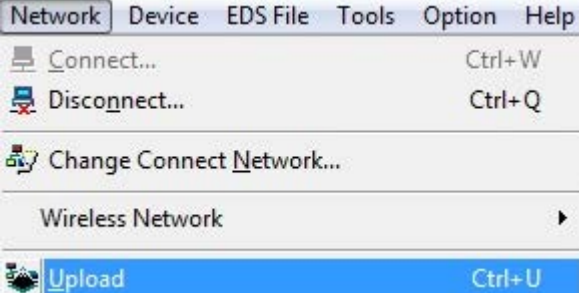
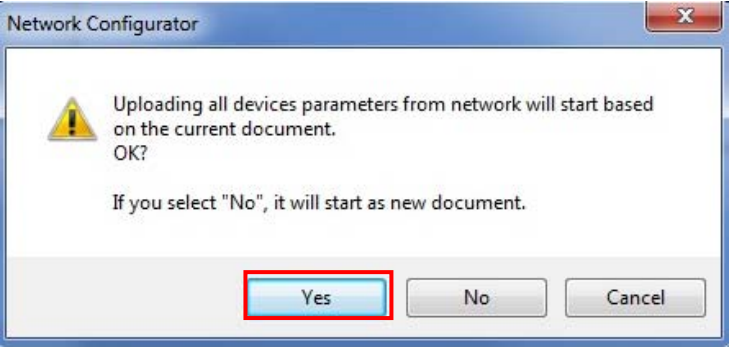
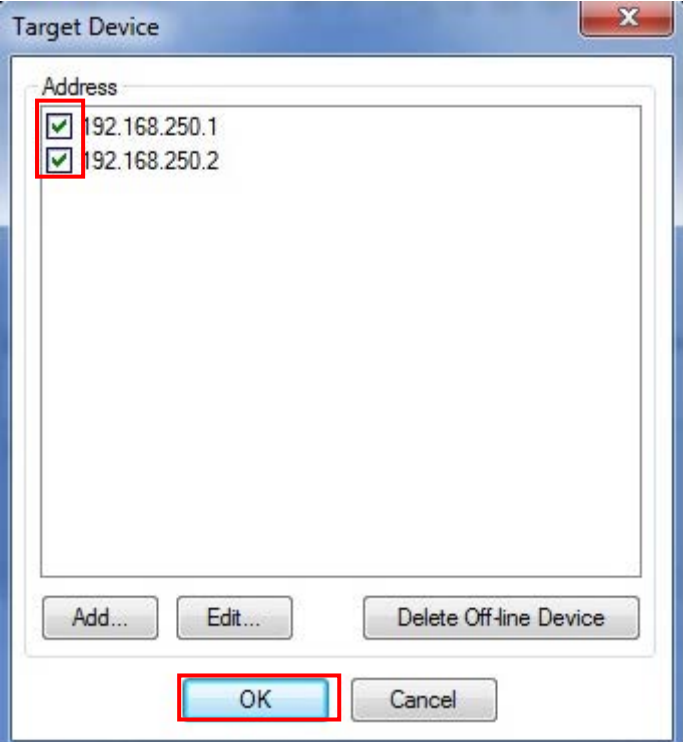
<p>7 Select Upload from the Network Menu to upload the device information on the network.</p>	
<p>8 The dialog box on the right is displayed. Confirm that there is no problem and click the Yes Button.</p>	
<p>9 The Target Device Dialog Box is displayed. Select the <i>192.168.250.1</i> Checkbox and the <i>192.168.250.2</i> Checkbox, and click the OK Button.</p> <p>*If 192.168.250.1 or 192.168.250.2 is not displayed on the dialog box, click the Add Button to add the address.</p> <p>*The displayed addresses depend on the status of the Network Configurator.</p>	

10 The device parameters are uploaded. When uploading is completed, the dialog box on the right is displayed. Check the contents and click the **OK** Button.

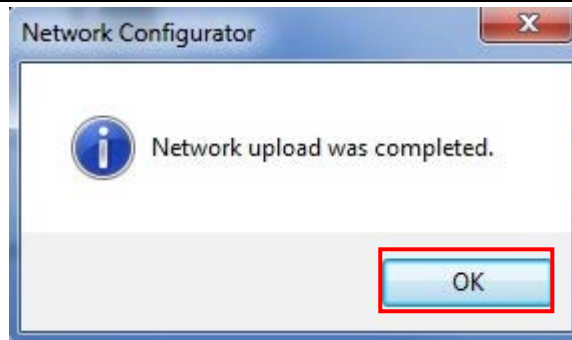

11 After uploading is completed, confirm that the Network Configuration Pane shows the updated IP addresses of the devices.
 IP address of node 1:
 192.168.250.1
 IP address of node 2:
 192.168.250.2

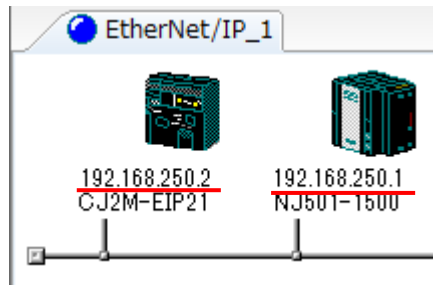

10.4.2. Setting the Tags and Tag Sets

Set the tags and tag sets of the send area and receive area of the PLC.

- 1 Right-click the node 2 device and select **Parameter - Edit**.

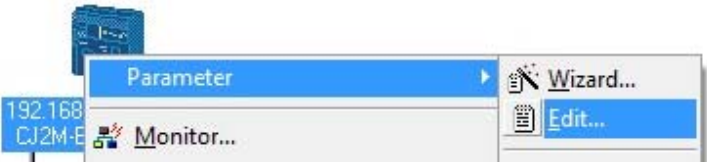

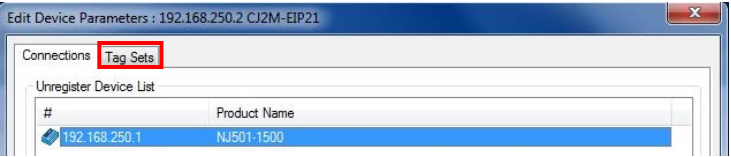
- 2 The Edit Device Parameters Dialog Box is displayed. Click the **Tag Sets** Tab.

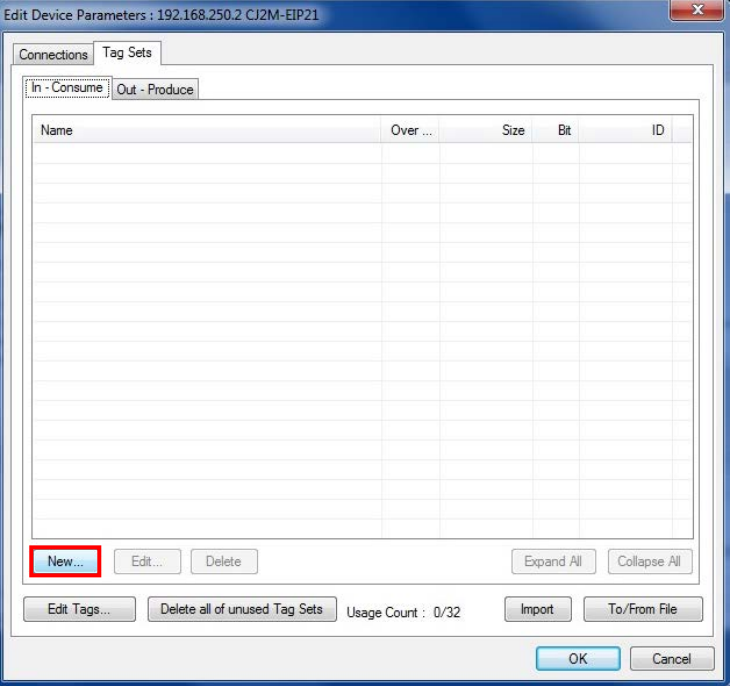
- 3 Click the **In - Consume** Tab. Click the **New** Button.

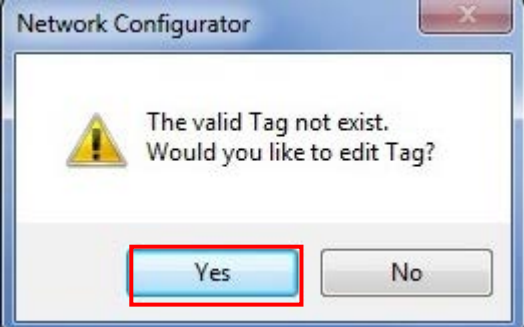

- 4 A confirmation dialog box is displayed. Click the **Yes** Button.

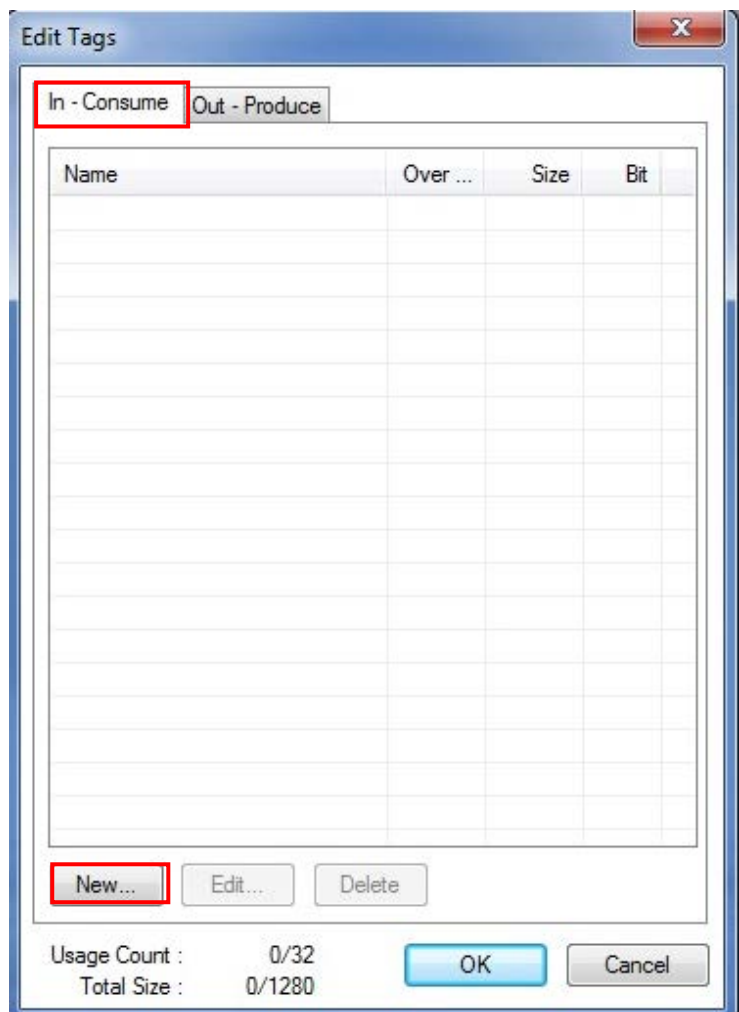

- 5 The Edit Tags Dialog Box is displayed. Select the **In - Consume** Tab and click the **New Button**.

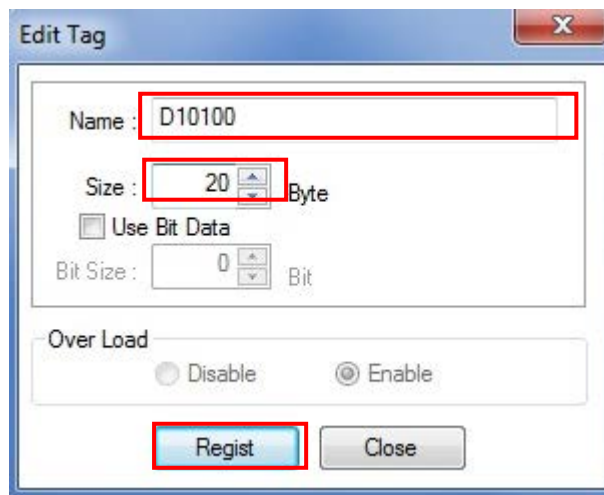

- 6 The Edit Tag Dialog Box is displayed. Set the following values and click the **Regist** Button.
 Name: D10100
 Size: 20 bytes



7 Click the **Close** Button.



8 The Edit Tag Dialog Box is displayed. Confirm that D10100 and 20Byte are displayed.

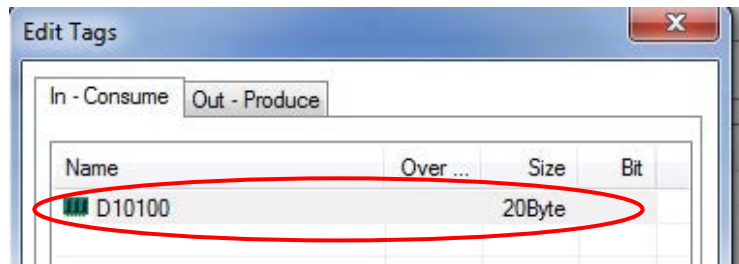

9 Select the **Out-Produce** Tab. Click the **New** Button.

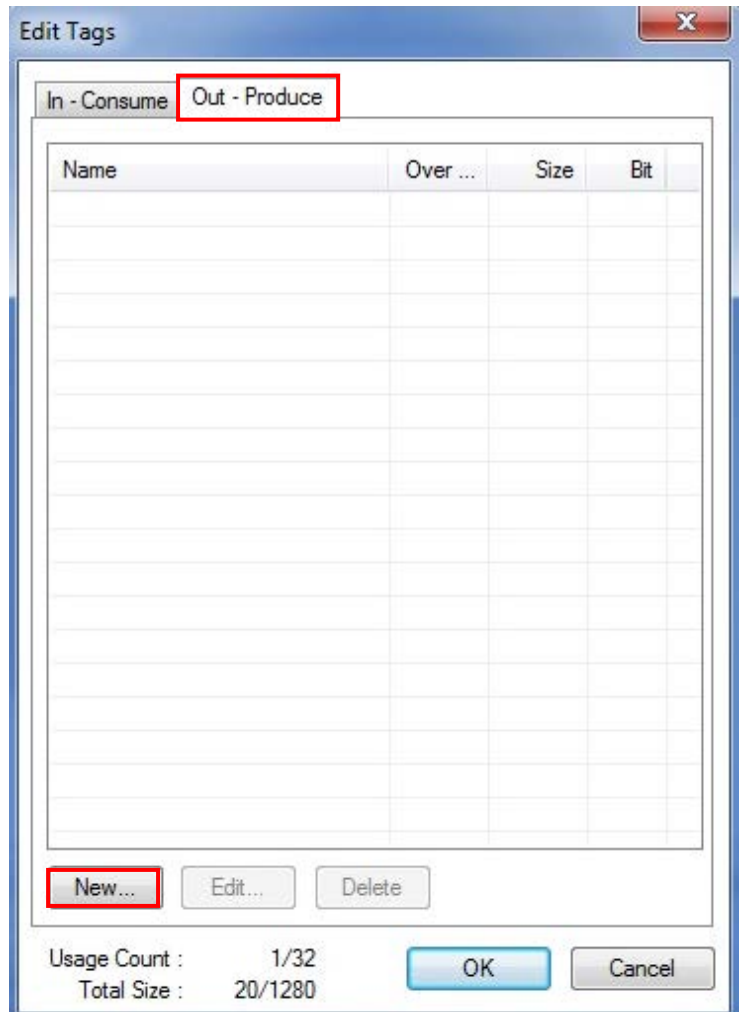

- 10 The Edit Tag Dialog Box is displayed.
Set the following values and click the **Regist** Button.
Name: D10000
Size: 20 Byte

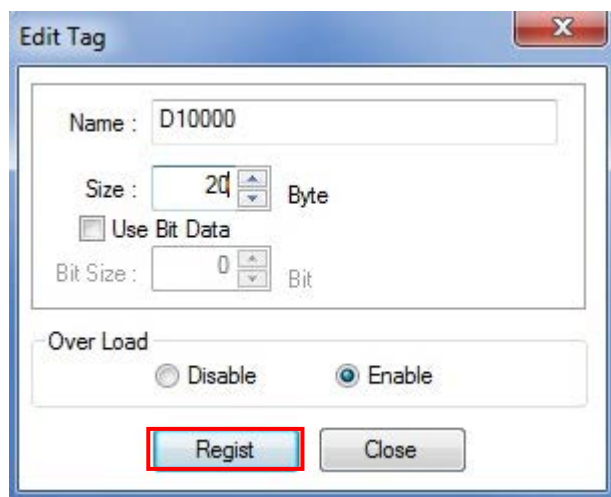

The screenshot shows the 'Edit Tag' dialog box. The 'Name' field contains 'D10000'. The 'Size' field is set to '20' with 'Byte' as the unit. The 'Use Bit Data' checkbox is unchecked. The 'Bit Size' field is set to '0' with 'Bit' as the unit. The 'Over Load' section has 'Enable' selected. The 'Regist' button is highlighted with a red rectangle.

- 11 Click the **Close** Button.



The screenshot shows the 'Edit Tag' dialog box with the same settings as the previous image. The 'Close' button is now highlighted with a red rectangle.

12 The Edit Tags Dialog Box is displayed.
Confirm that D10000 and 20Byte are displayed.

After confirming, click the **OK** Button.

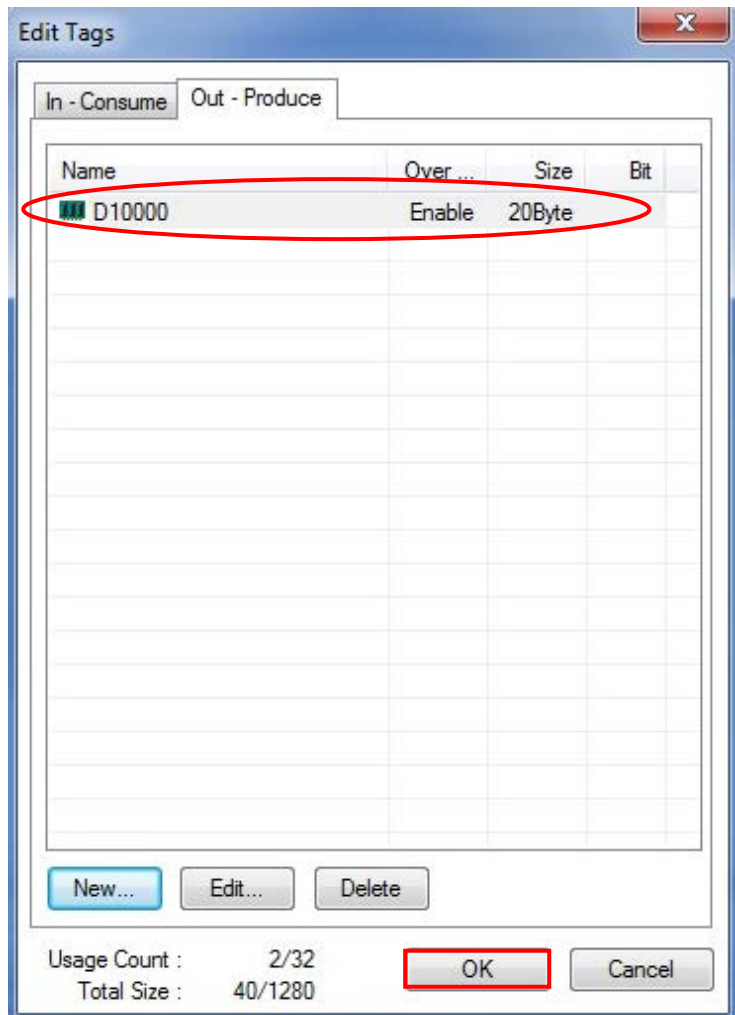

13 Click the **Yes** Button.

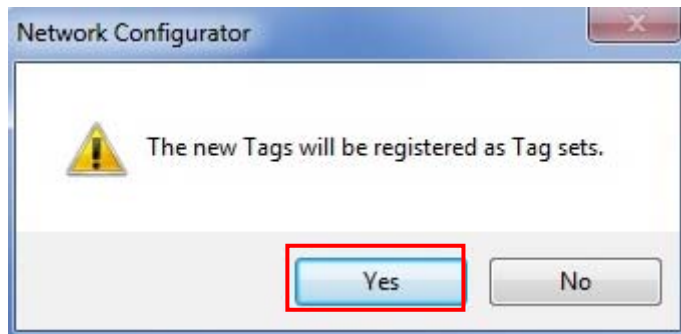

14 The Edit Device Parameters Dialog Box is displayed. D10100 and 20Byte are displayed.

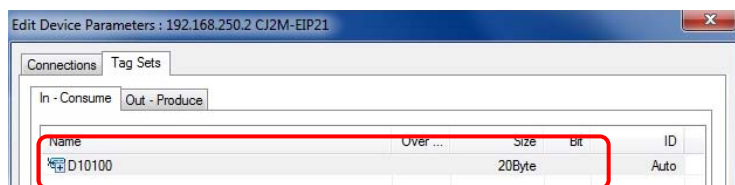

15 Click the **Out-Produce** Tab. D10000 and 20Byte are displayed.

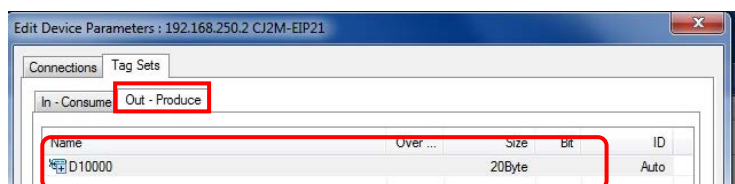

16 Click the **OK** Button.

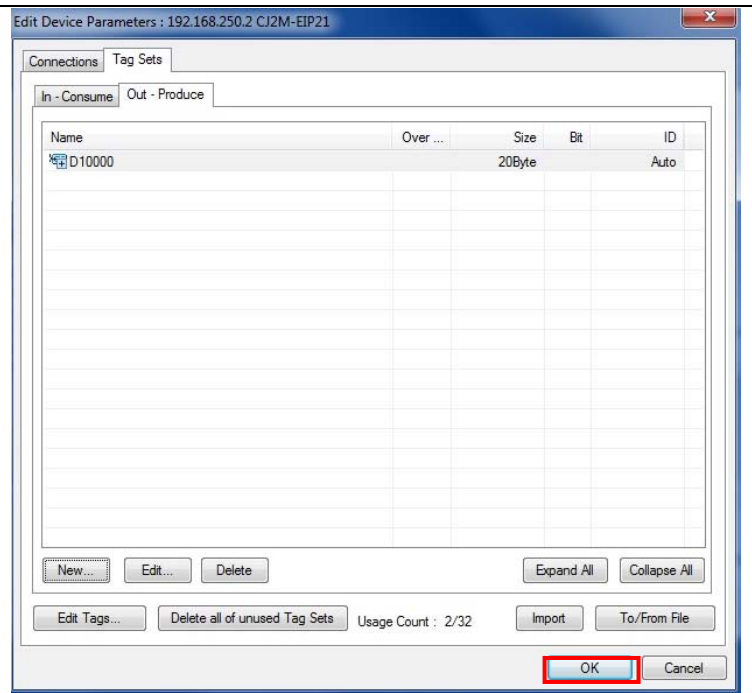



10.4.3. Importing the File, Registering the Tags and Setting the Tag Sets

Import the CSV file that was saved, register tags of the originator's send area and receive area, and set the tag sets.

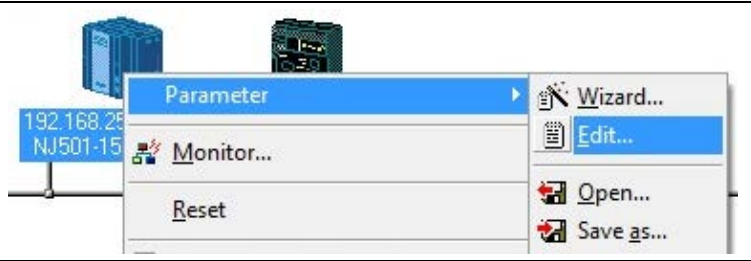
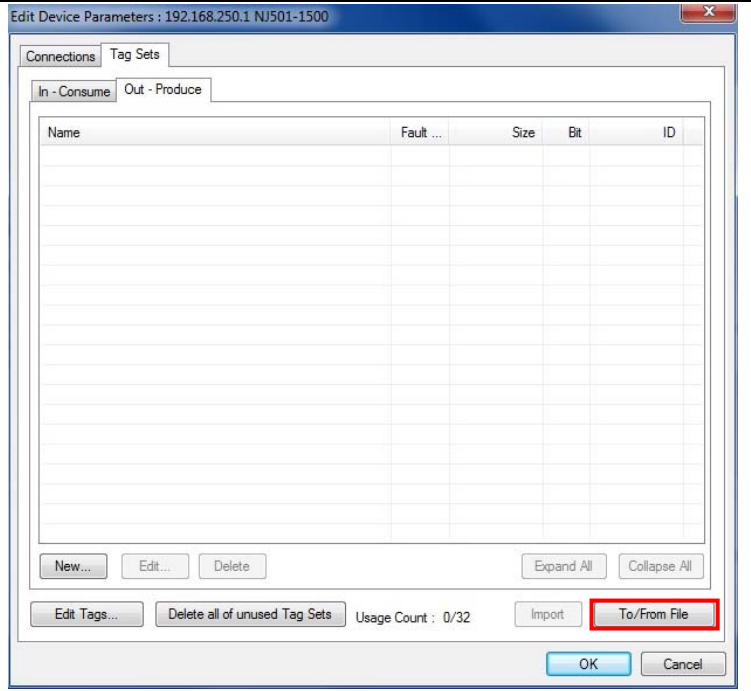
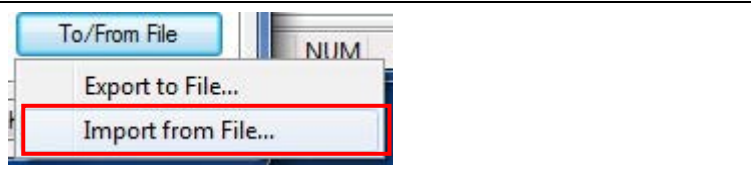
This section explains the receive settings and then send settings of the target node.

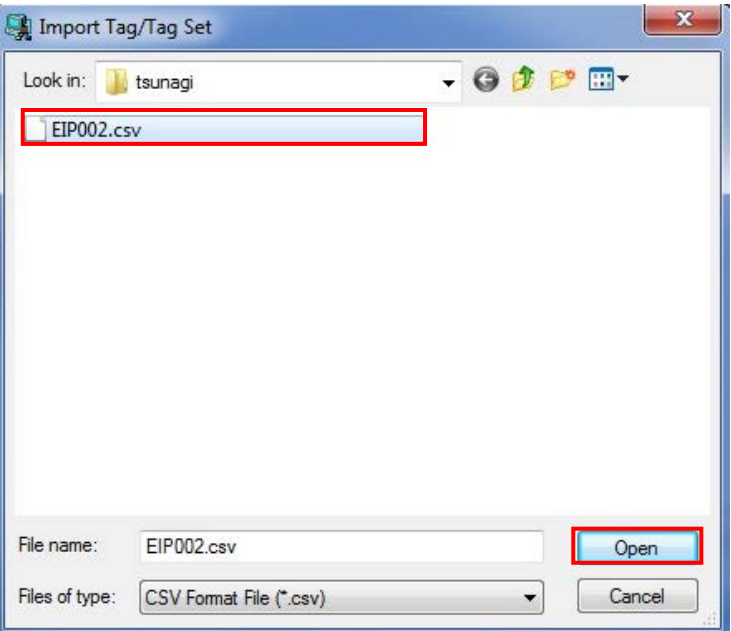
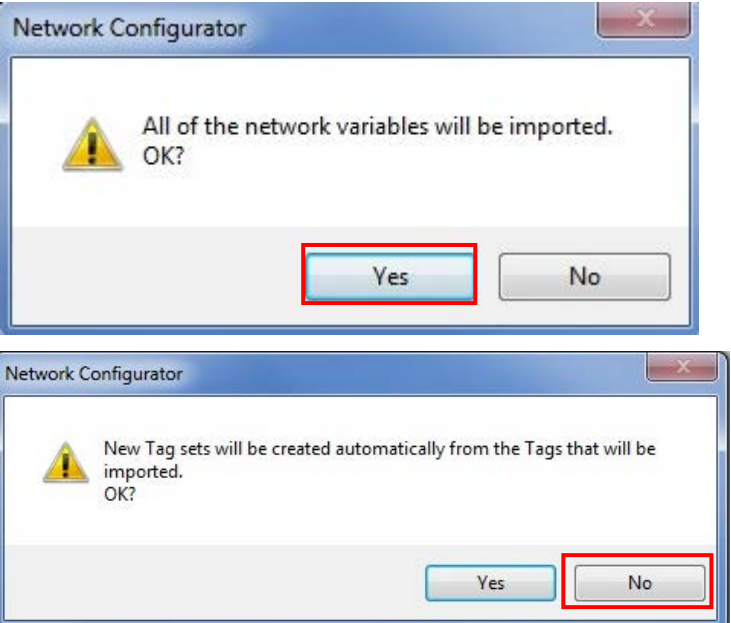
<p>1 On the Network Configuration Pane of the Network Configurator, right-click the node 1 device and select Parameter - Edit.</p>	
<p>2 The Edit Device Parameters Dialog Box is displayed. Click the To/From File Button.</p>	
<p>3 Select Import from File.</p>	

<p>4 The Import Connection Configuration Dialog Box is displayed. Select EIP002.csv and click the Open Button.</p> <p>*In the <i>Look in</i> Field, specify the folder in which the file was saved in Section 10.3.3 Exporting the Global Variables.</p>	
<p>5 The right dialog boxes may not be displayed depending on the status of the Controller and software used. In such a case, proceed to the next step.</p> <p>The right dialog box is displayed. Confirm that there is no problem and click the Yes Button.</p> <p>The right dialog box is displayed. Confirm that there is no problem and click the No Button.</p> <p>Make sure that tag sets are not created automatically.</p>	
<p>6 The Edit Tags Dialog Box is displayed again. Click the Tag Sets Tab.</p>	

7 The data on the Tag Sets Tab is displayed. Select the **In-Consume** Tab and click the **Edit Tags**.

Here, register an area (node 2 → node 1) where node 1 receives data.

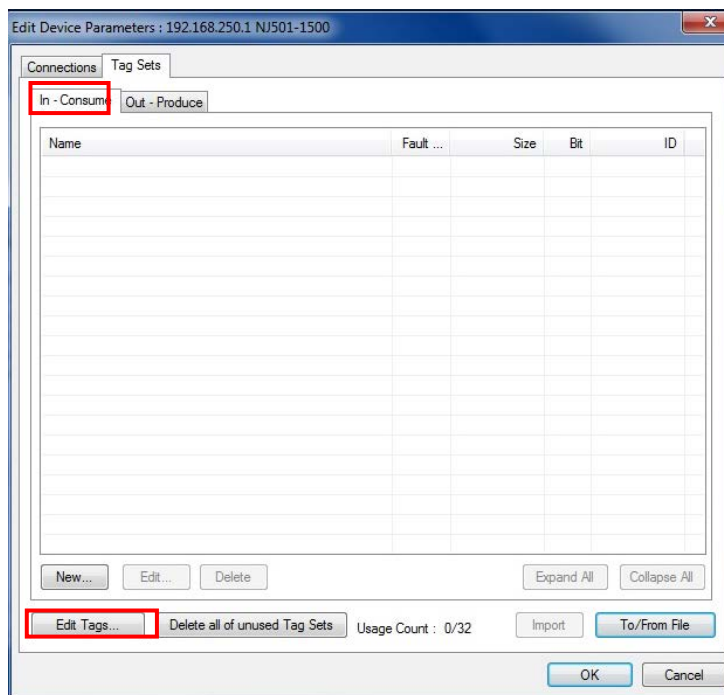

8 The Edit Tags Dialog Box is displayed. Select the **In - Consume** Tab. The tab page shows the variable name that was set in 10.3.2 Setting the Global Variables and that is listed in 9.2. Relationship between Destination Device and Global Variables.

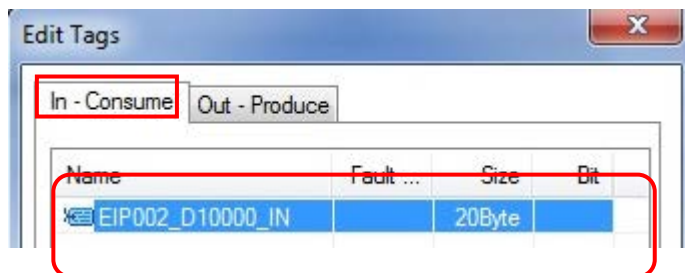

- 9 Select the **Out-Produce** Tab.
 In the same way as the previous step, the tab page shows the variable name that was set in 10.3.2 Setting the Global Variables and that is listed in 9.2. Relationship between Destination Device and Global Variables.

Click the **OK** Button.

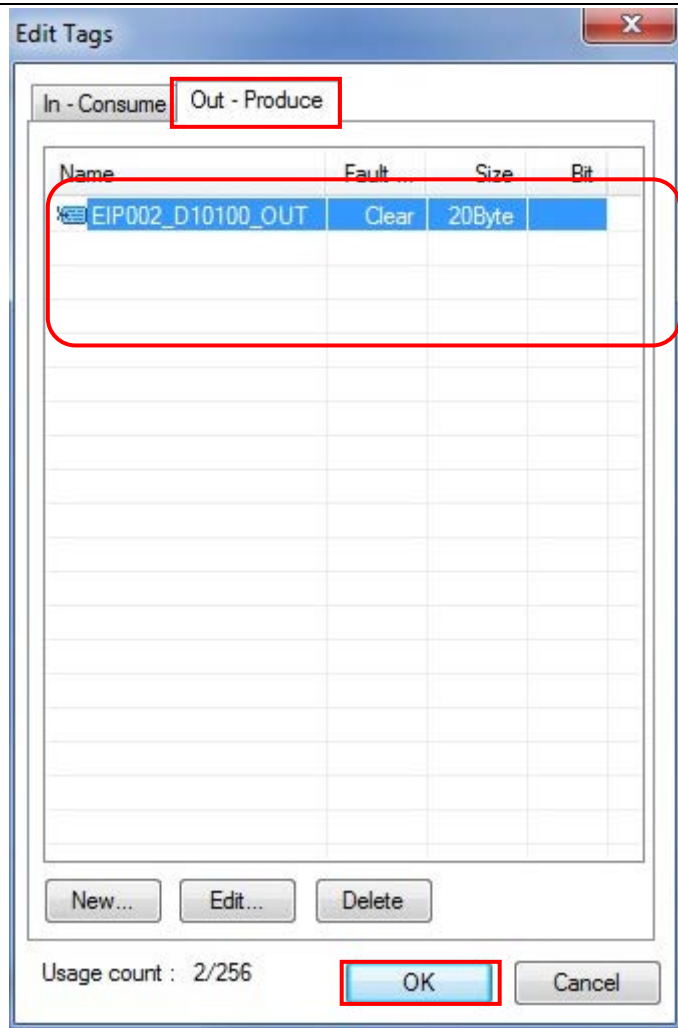

- 10 The Edit Tags Dialog Box is displayed again.
 Click the **New** Button.

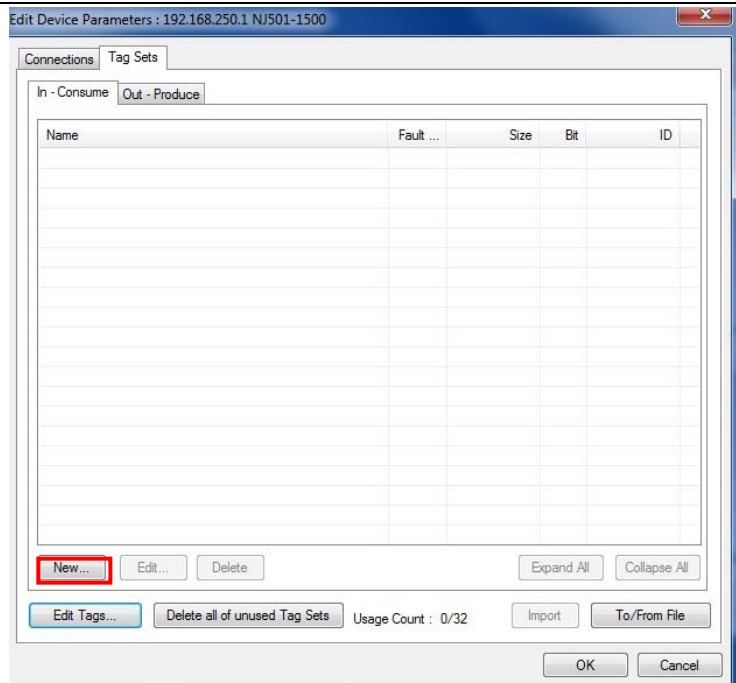

11 The Edit Tag Set Dialog Box is displayed.
Select EIP002_D10000_IN from the Candidate Tag List and click the << Button.

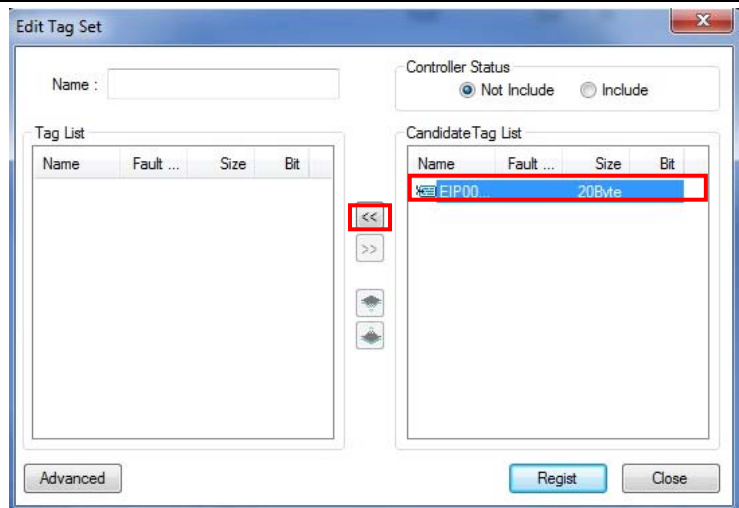

12 EIP002_D10000_IN moves to the Tag List.
Move all variables from the Candidate Tag List to the Tag List in the same way.

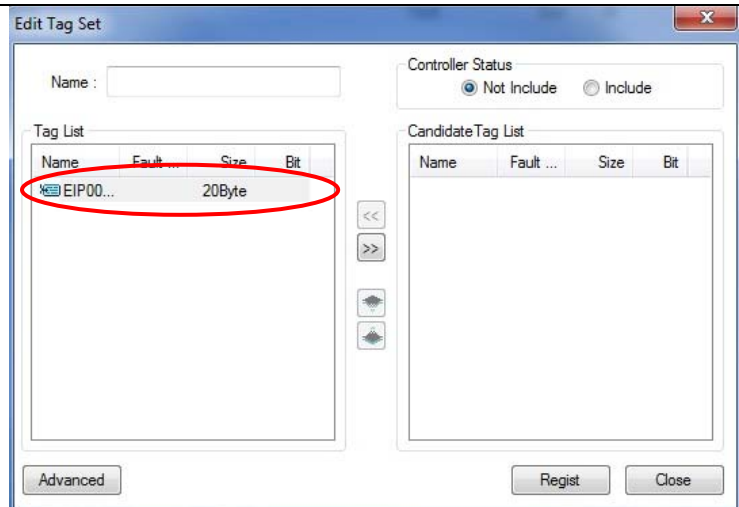

13 Enter EIP002_IN in the Name Field.
Click the **Regist** Button.

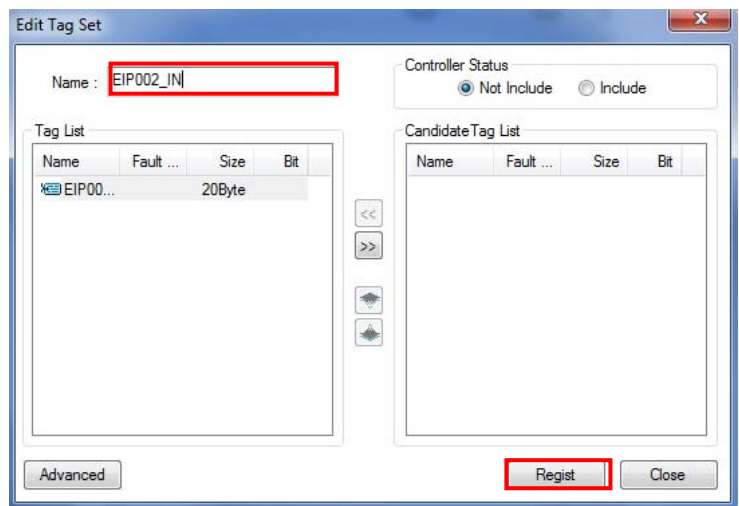

14 The Edit Device Parameters Dialog Box is displayed. Click the **Close** Button.



15 The Edit Device Parameters Dialog Box is displayed.
EIP002_IN and 20Byte are displayed.

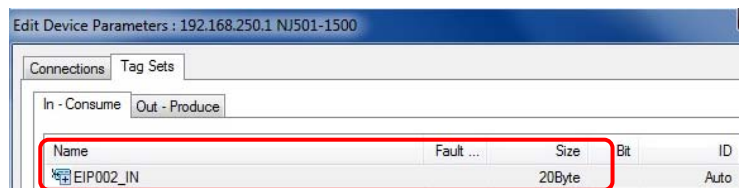

- 16 Select the **Out-Produce** Tab.
Click the **New** Button.

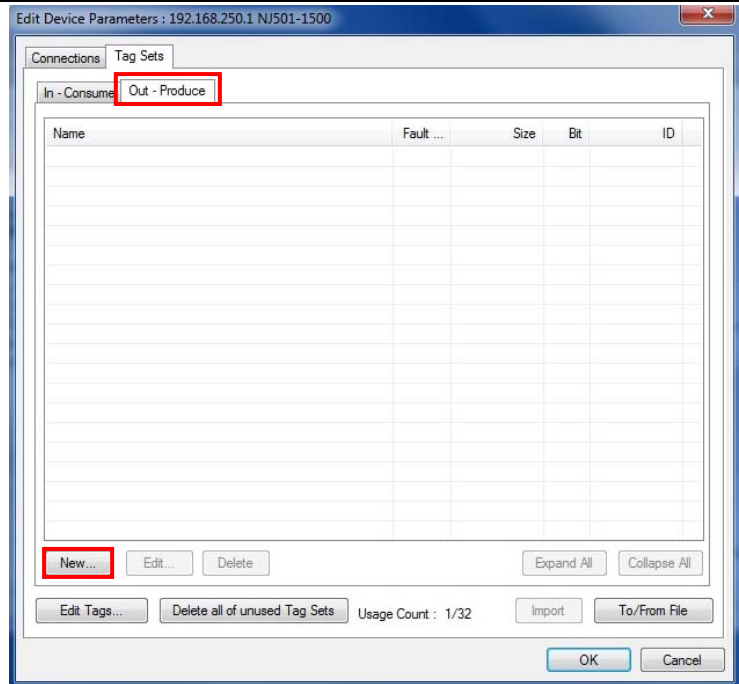

- 17 The Edit Tag Set Dialog Box is displayed.
Move the variables from the Candidate Tag List to the Tag List in the same way as steps 11 and 12.

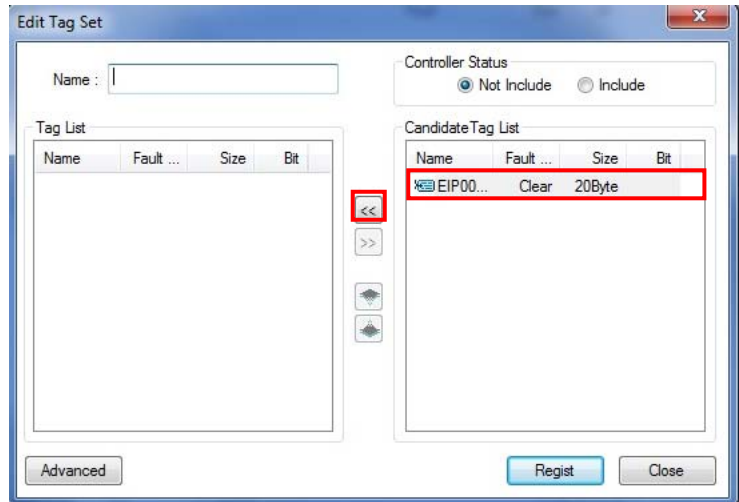

*Make sure that the data in the Tag List is arranged in order of offsets shown in 9.2.

Relationship between Destination Device and Global Variables.

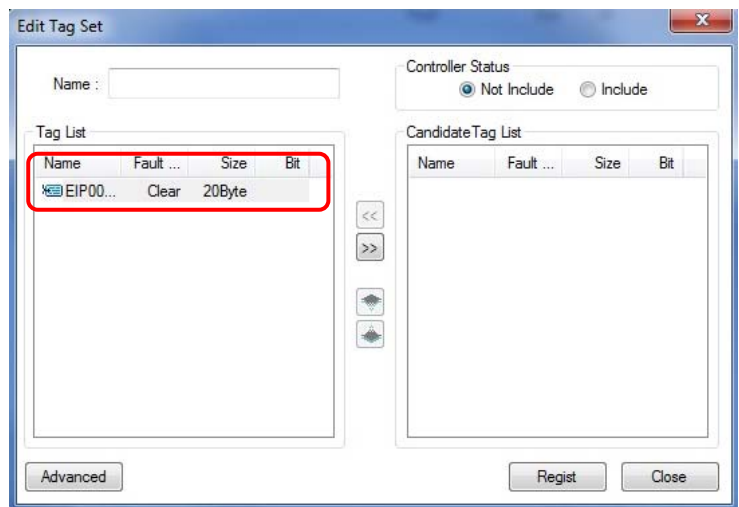

18 Enter *EIP002_OUT* in the Name Field.

Click the **Regist** Button.

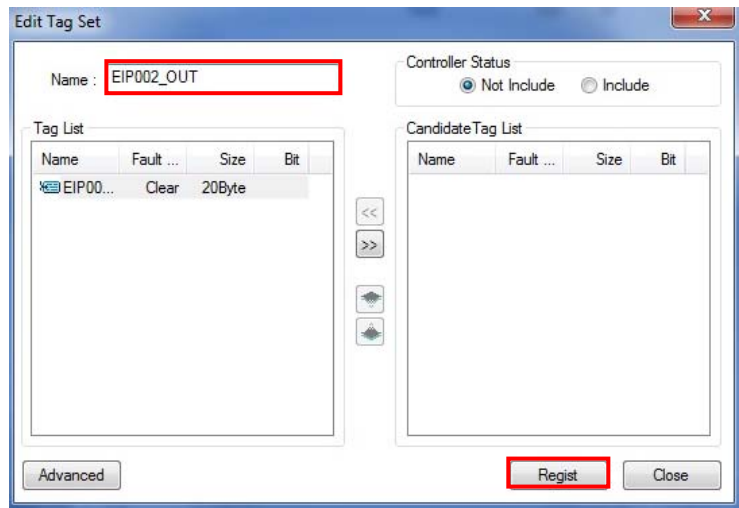

19 The Edit Tag Set Dialog Box is displayed. Click the **Close** Button.



20 The Edit Tags Dialog Box is displayed again. *EIP002_OUT* and 20Byte are displayed. Select the **Connections** Tab.

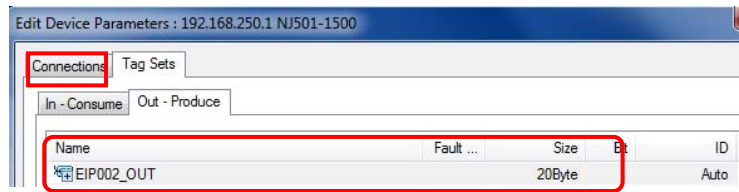

10.4.4. Setting the Connection

Associate the tags of the target device (that receives the open request) with the tags of the originator (that requests opening).

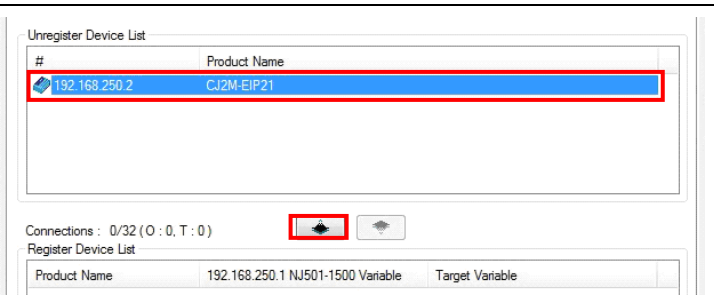
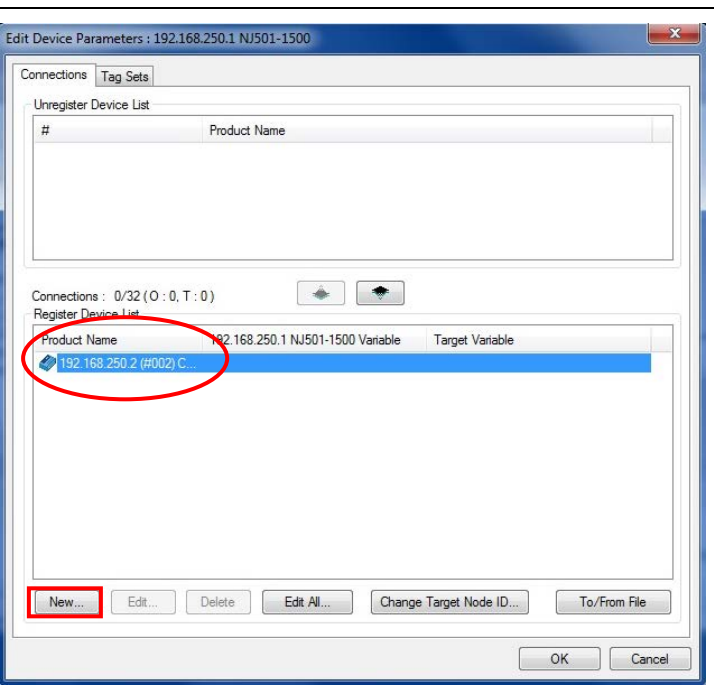
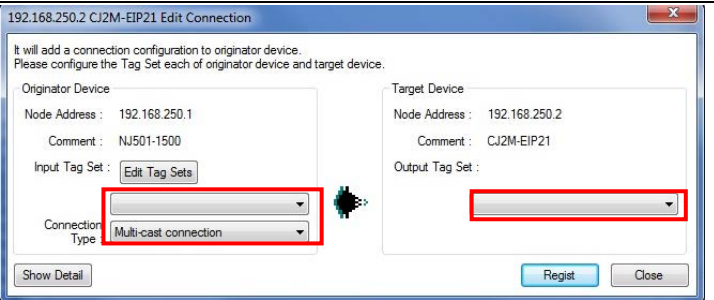
<p>1 Select 192.168.250.2 in the <i>Unregister Device List</i> Field. Click the Down Arrow that is shown in the dialog box.</p>	
<p>2 192.168.250.2 is registered in the Register Device List. Select 192.168.250.2 and click the New Button.</p>	
<p>3 The Edit Connection Dialog Box is displayed. Select the following values from the pull-down lists for the settings in the <i>Originator Device</i> Field and the <i>Target Device</i> Field.</p>	

■ Settings of connection

Connection allocation		Setting value
Originator device	Input Tag Set	EIP002_IN - [20Byte]
	Connection Type	Multi-cast connection
Target Device	Output Tag Set	D10000 - [20Byte]

4 Confirm that the settings are correct and click the **Register** Button.

5 The Edit Connection Dialog Box is displayed again. Click the **Close** Button.

6 The Edit Device Parameters Dialog Box is displayed again. Click the **OK** Button.

Product Name	Variable	Target Variable
192.168.250.2 (#002) C.	default_001 [Input]	EIP002_IN, D10000

7 When the connection is completely allocated, the registration destination node address is displayed under the device icon of the destination device on the Network Configuration Pane.

8 Right-click the node 2 device and select **Parameter - Edit**.

9 Select 192.168.250.1 in the *Unregister Device List* Field. Click the **Down Arrow** that is shown in the dialog box.

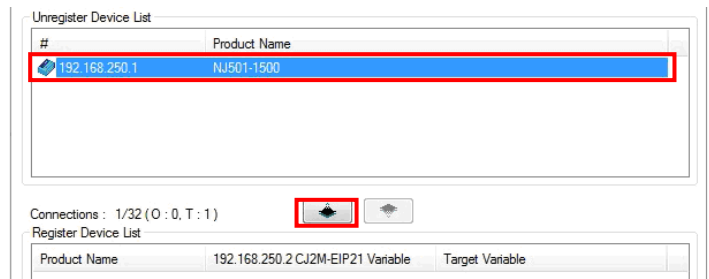

10 192.168.250.1 is registered in the Register Device List. Select 192.168.250.1 and click the **New** Button.

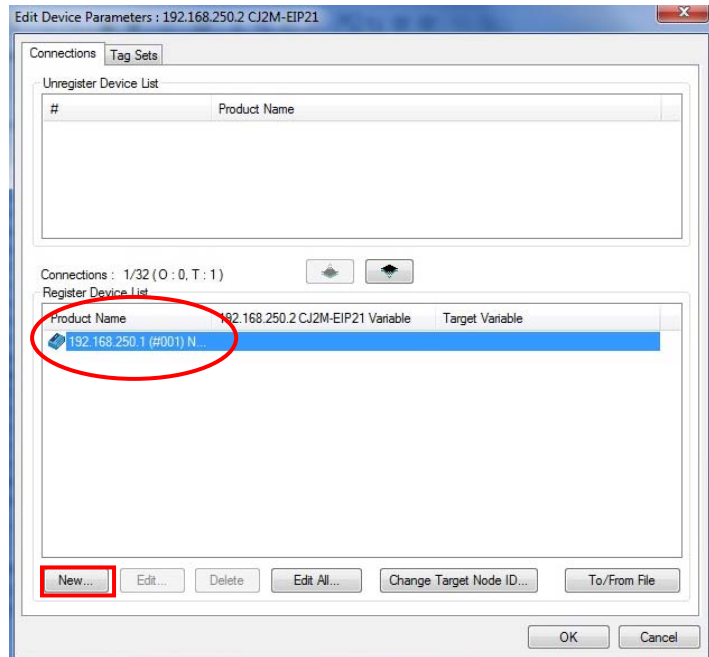

11 The Edit Connection Dialog Box is displayed. Select the following values from the pull-down lists for the settings in the *Originator Device* Field and the *Target Device* Field.

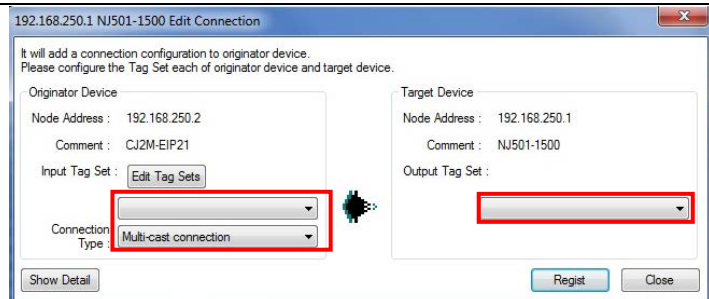

■ Settings of connection

Connection allocation		Setting value
Originator device	Input Tag Set	D10100 - [20Byte]
	Connection Type	Multi-cast connection
Target Device	Output Tag Set	EIP002_OUT - [20Byte]

12 Confirm that the settings are correct and click the **Register** Button.



13 The Edit Connection Dialog Box is displayed again. Click the **Close** Button.

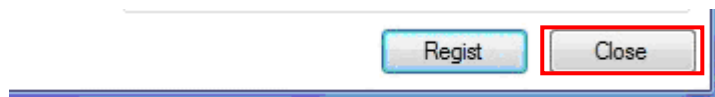

14 The Edit Device Parameters Dialog Box is displayed again. Click the **OK** Button.

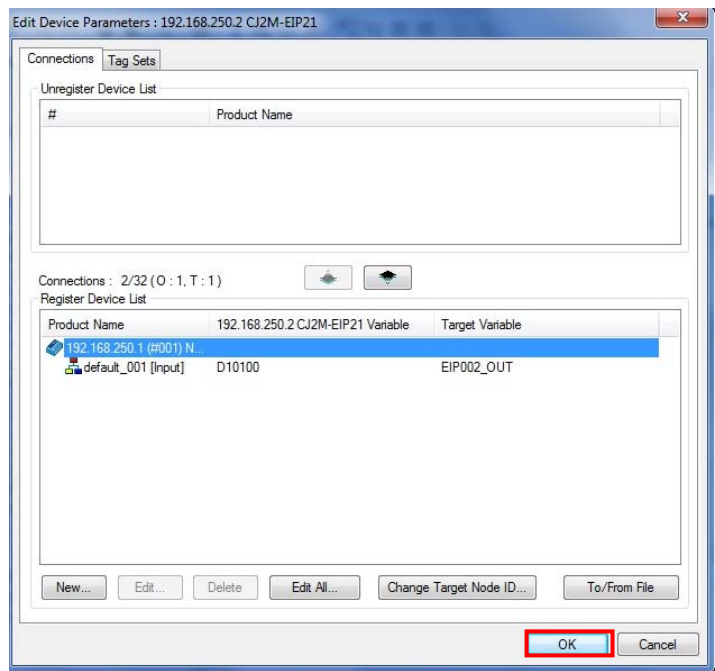

15 When the connection is completely allocated, the registration destination node address is displayed under the device icon of the destination device on the Network Configuration Pane.

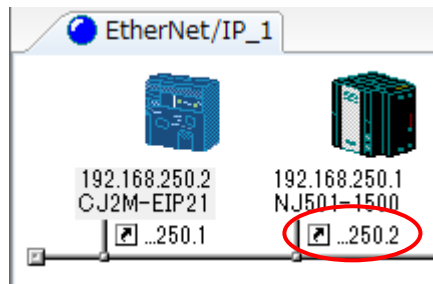

10.4.5. Transferring the Tag Data Link Parameters

Transfer the set tag data link parameters to the Controller.

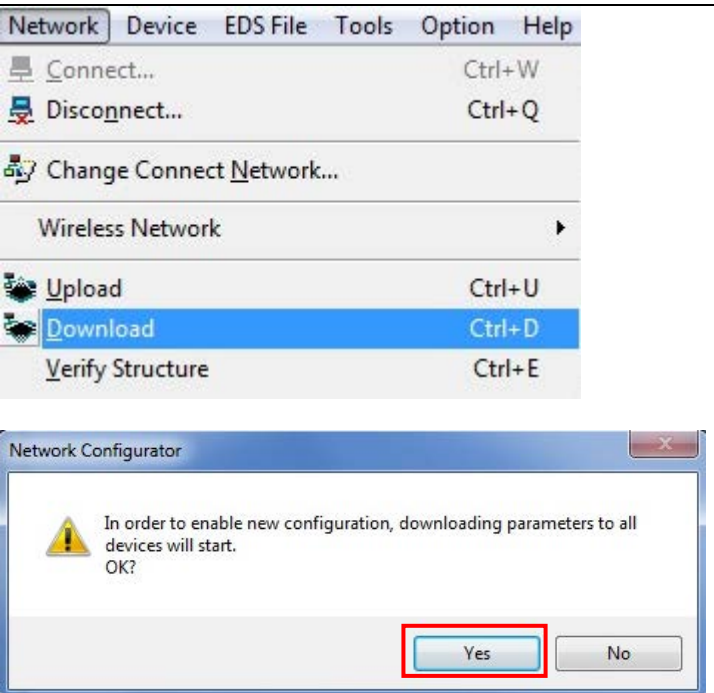
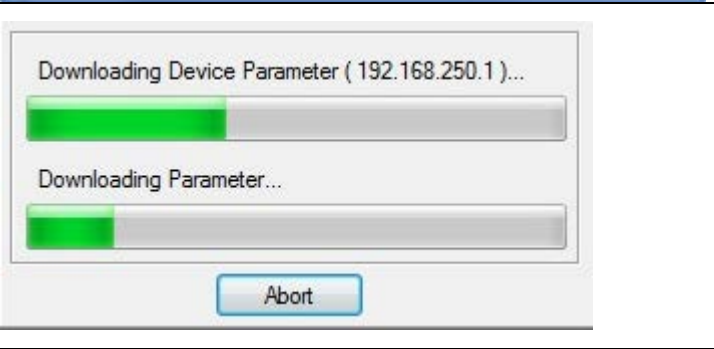
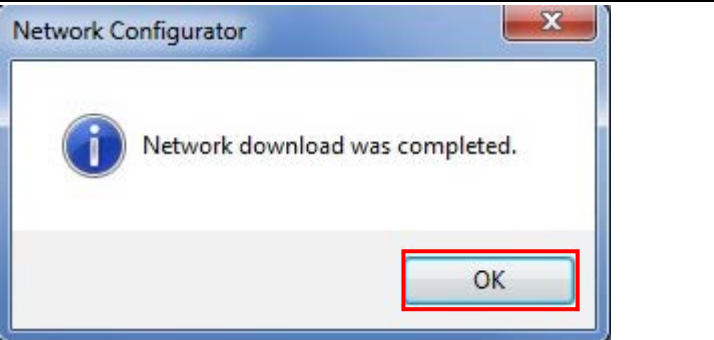
<p>1 Select Download from the Network Menu.</p> <p>The dialog box on the right is displayed. Confirm that there is no problem and click the Yes Button.</p>	 <p>The top screenshot shows the 'Network' menu with 'Download' selected. The bottom screenshot shows the 'Network Configurator' dialog box with a warning icon and the text: 'In order to enable new configuration, downloading parameters to all devices will start. OK?' The 'Yes' button is highlighted with a red box.</p>
<p>2 Tag data link parameters are downloaded from the Network Configurator to the Controller.</p>	 <p>The screenshot shows the 'Network Configurator' dialog box with two progress bars. The first bar is labeled 'Downloading Device Parameter (192.168.250.1)...' and the second is 'Downloading Parameter...'. An 'Abort' button is visible at the bottom.</p>
<p>3 The dialog box on the right is displayed. Check the contents and click the OK Button.</p>	 <p>The screenshot shows the 'Network Configurator' dialog box with an information icon and the text: 'Network download was completed.' The 'OK' button is highlighted with a red box.</p>

11. Revision History

Revision code	Date of revision	Revision reason and revision page
01	Sep. 6, 2013	First edition

OMRON Corporation Industrial Automation Company

Tokyo, JAPAN

Contact: www.ia.omron.com

Regional Headquarters

OMRON EUROPE B.V.

Wegalaan 67-69-2132 JD Hoofddorp
The Netherlands

Tel: (31)2356-81-300/Fax: (31)2356-81-388

OMRON ELECTRONICS LLC

One Commerce Drive Schaumburg,
IL 60173-5302 U.S.A.

Tel: (1) 847-843-7900/Fax: (1) 847-843-7787

OMRON ASIA PACIFIC PTE. LTD.

No. 438A Alexandra Road # 05-05/08 (Lobby 2),
Alexandra Technopark,
Singapore 119967

Tel: (65) 6835-3011/Fax: (65) 6835-2711

OMRON (CHINA) CO., LTD.

Room 2211, Bank of China Tower,
200 Yin Cheng Zhong Road,
PuDong New Area, Shanghai, 200120, China

Tel: (86) 21-5037-2222/Fax: (86) 21-5037-2200

Authorized Distributor:

© OMRON Corporation 2013 All Rights Reserved.
In the interest of product improvement,
specifications are subject to change without notice.

Cat. No. P568-E1-01

0911(-)