

1
Product
Overview

2
IP Address Setting
and Resetting

3
Monitoring and
Setting with the
EtherNet/IP

4
Monitoring and
Setting with the
Modbus TCP

Switch-mode Power Supplies

Communications Manual S8VK-X



NOTE

All rights reserved. No part of this publication may be reproduced, stored in a retrieval system, or transmitted, in any form, or by any means, mechanical, electronic, photocopying, recording, or otherwise, without the prior written permission of OMRON.

No patent liability is assumed with respect to the use of the information contained herein. Moreover, because OMRON is constantly striving to improve its high-quality products, the information contained in this manual is subject to change without notice. Every precaution has been taken in the preparation of this manual. Nevertheless, OMRON assumes no responsibility for errors or omissions. Neither is any liability assumed for damages resulting from the use of the information contained in this publication.

Trademarks

- Microsoft, Windows is either registered trademarks or trademarks of Microsoft Corporation in the United States and other countries.
- ODVA, CIP, CompoNet, DeviceNet, and EtherNet/IP are trademarks of ODVA.
- Modbus is a registered trademark of Schneider Electric.

Other company names and product names in this document are the trademarks or registered trademarks of their respective companies.

Copyrights

Microsoft product screen shots reprinted with permission from Microsoft Corporation.

Preface

Thank you for purchasing S8VK-X Switch-mode Power Supplies.

This communications manual describes how to use the communications functions of the S8VK-X. Read this manual thoroughly and be sure you understand it before attempting to use the S8VK-X correctly according to the information provided. Keep this manual in a safe place for easy reference.

PDF version of this manual can be downloaded from the OMRON website.

(<http://www.omron.co.jp>)

For details on how to use functions other than the S8VK-X communications function, refer to the data sheet of the S8VK-X and the instruction manual (attached to the product).

Terms and Conditions Agreement

Warranty, Limitations of Liability

Warranties

- **Exclusive Warranty**

Omron's exclusive warranty is that the Products will be free from defects in materials and workmanship for a period of twelve months from the date of sale by Omron (or such other period expressed in writing by Omron). Omron disclaims all other warranties, express or implied.

- **Limitations**

OMRON MAKES NO WARRANTY OR REPRESENTATION, EXPRESS OR IMPLIED, ABOUT NON-INFRINGEMENT, MERCHANTABILITY OR FITNESS FOR A PARTICULAR PURPOSE OF THE PRODUCTS. BUYER ACKNOWLEDGES THAT IT ALONE HAS DETERMINED THAT THE PRODUCTS WILL SUITABLY MEET THE REQUIREMENTS OF THEIR INTENDED USE.

Omron further disclaims all warranties and responsibility of any type for claims or expenses based on infringement by the Products or otherwise of any intellectual property right.

- **Buyer Remedy**

Omron's sole obligation hereunder shall be, at Omron's election, to (i) replace (in the form originally shipped with Buyer responsible for labor charges for removal or replacement thereof) the non-complying Product, (ii) repair the non-complying Product, or (iii) repay or credit Buyer an amount equal to the purchase price of the non-complying Product; provided that in no event shall Omron be responsible for warranty, repair, indemnity or any other claims or expenses regarding the Products unless Omron's analysis confirms that the Products were properly handled, stored, installed and maintained and not subject to contamination, abuse, misuse or inappropriate modification. Return of any Products by Buyer must be approved in writing by Omron before shipment. Omron Companies shall not be liable for the suitability or unsuitability or the results from the use of Products in combination with any electrical or electronic components, circuits, system assemblies or any other materials or substances or environments. Any advice, recommendations or information given orally or in writing, are not to be construed as an amendment or addition to the above warranty.

See <http://www.omron.com/global/> or contact your Omron representative for published information.

Limitation on Liability; Etc

OMRON COMPANIES SHALL NOT BE LIABLE FOR SPECIAL, INDIRECT, INCIDENTAL, OR CONSEQUENTIAL DAMAGES, LOSS OF PROFITS OR PRODUCTION OR COMMERCIAL LOSS IN ANY WAY CONNECTED WITH THE PRODUCTS, WHETHER SUCH CLAIM IS BASED IN CONTRACT, WARRANTY, NEGLIGENCE OR STRICT LIABILITY.

Further, in no event shall liability of Omron Companies exceed the individual price of the Product on which liability is asserted.

Application Considerations

Suitability of Use

Omron Companies shall not be responsible for conformity with any standards, codes or regulations which apply to the combination of the Product in the Buyer's application or use of the Product. At Buyer's request, Omron will provide applicable third party certification documents identifying ratings and limitations of use which apply to the Product. This information by itself is not sufficient for a complete determination of the suitability of the Product in combination with the end product, machine, system, or other application or use. Buyer shall be solely responsible for determining appropriateness of the particular Product with respect to Buyer's application, product or system. Buyer shall take application responsibility in all cases.

NEVER USE THE PRODUCT FOR AN APPLICATION INVOLVING SERIOUS RISK TO LIFE OR PROPERTY OR IN LARGE QUANTITIES WITHOUT ENSURING THAT THE SYSTEM AS A WHOLE HAS BEEN DESIGNED TO ADDRESS THE RISKS, AND THAT THE OMRON PRODUCT(S) IS PROPERLY RATED AND INSTALLED FOR THE INTENDED USE WITHIN THE OVERALL EQUIPMENT OR SYSTEM.

Programmable Products

Omron Companies shall not be responsible for the user's programming of a programmable Product, or any consequence thereof.

Disclaimers

Performance Data

Data presented in Omron Company websites, catalogs and other materials is provided as a guide for the user in determining suitability and does not constitute a warranty. It may represent the result of Omron's test conditions, and the user must correlate it to actual application requirements. Actual performance is subject to the Omron's Warranty and Limitations of Liability.

Change in Specifications

Product specifications and accessories may be changed at any time based on improvements and other reasons. It is our practice to change part numbers when published ratings or features are changed, or when significant construction changes are made. However, some specifications of the Product may be changed without any notice. When in doubt, special part numbers may be assigned to fix or establish key specifications for your application. Please consult with your Omron's representative at any time to confirm actual specifications of purchased Product.

Errors and Omissions

Information presented by Omron Companies has been checked and is believed to be accurate; however, no responsibility is assumed for clerical, typographical or proofreading errors or omissions.

Safety Precautions

Definition of Precautionary Information

The following notation is used in this manual to provide precautions required to ensure safe usage of the Product.

The safety precautions that are provided are extremely important to safety. Always read and heed the information provided in all safety precautions. The following notation is used.





 CAUTION	Indicates a potentially hazardous situation which, if not avoided, is likely to result in minor or moderate injury or in property damage.
--	---

Symbols

Symbol	Meaning
Mandatory Caution	
	General instructions Indicates instructions on unspecified general action

Take adequate security measures against DDoS attacks (Distributed Denial of Service attacks), computer viruses and other technologically harmful programs, unauthorized access and other possible attacks before using this product.

Security Measures

<p>Anti-virus protection</p> <p>Install the latest commercial-quality antivirus software on the computer connected to the control/monitor system and maintain to keep the software up-to-date.</p>	
<p>Security measures to prevent unauthorized access</p> <p>Take the following measures to prevent unauthorized access to our products.</p> <ul style="list-style-type: none"> • Install physical controls so that only authorized personnel can access control/monitor systems and equipment. • Reduce connections to control/monitor systems and equipment via networks to prevent access from untrusted devices. • Install firewalls to shut down unused communications ports and limit communications hosts and isolate control/monitor systems and equipment from the IT network. • Use a virtual private network (VPN) for remote access to control/monitor systems and equipment. • Scan virus to ensure safety of SD cards or other external storages before connecting them to control/monitor systems and equipment. 	
<p>Data input and output protection</p> <p>Validate backups and ranges to cope with unintentional modification of input/output data to control/monitor systems and equipment.</p> <ul style="list-style-type: none"> • Checking the scope of data • Checking validity of backups and preparing data for restore in case of falsification and abnormalities • Safety design, such as emergency shutdown, in case of data tampering and abnormalities 	
<p>Data recovery</p> <p>Backup data and keep the data up-to-date periodically to prepare for data loss.</p>	

Precautions for Correct Use

Be sure to observe the following precautions.

● Communications

- Communications setup is necessary for installation and replacement. Make communication settings according to this manual.
- Follow the instructions in this manual for connection method and cables to be used with the EtherNet/IP or the Modbus TCP. Otherwise, communication failure may occur.
- Do not exceed the communications distance that is given in the specifications.
- If EtherNet/IP tag data links (cyclic communications) are used with a repeating hub, the communications load on the network will increase. This will increase collisions and may prevent stable communications.

● Communications Cables

- Do not pull on the communications cables or bend the cables beyond their natural limit. Do not place heavy objects on top of the communications cables or other wiring lines. Doing so may cause the wire to break.
- To avoid inductive noise, keep the communications cables away from power cables carry high voltages or large currents. Also, do not wire power lines together with or parallel to product wiring.
- If no communication cable is connected, attach a dust cover.
- Depending on the ambient temperature or the load ratio, the product itself may have a high temperature. In that case, do not insert or remove the communications cable. Otherwise, minor burns may occasionally occur.

Revision History

A manual revision code appears as a suffix to the catalog number on the front cover of the manual.

Man.No.	T213-E1-06
----------------	-------------------

↑
Revision code

Revision code	Date	Revised content
01	December 2017	Original production
02	November 2018	Made changes accompanying the following corrections. Page 2: Correction of <i>Terms and Conditions Agreement</i> Page 2-2: Added descriptions on IP address settings Page 3-2: Added descriptions on the multicast communications of tag data link
03	January 2019	Page 3-2: Changed descriptions on multicast communications of tag data link.
04	February 2019	Page 3-2: Changed descriptions on multicast communications of tag data link.
05	April 2020	Page 1-5: Added descriptions on the number of clients that can communicate at one time in the communications specifications.
06	September 2022	Added information on <i>Safety Precautions</i> .

Sections in this Manual

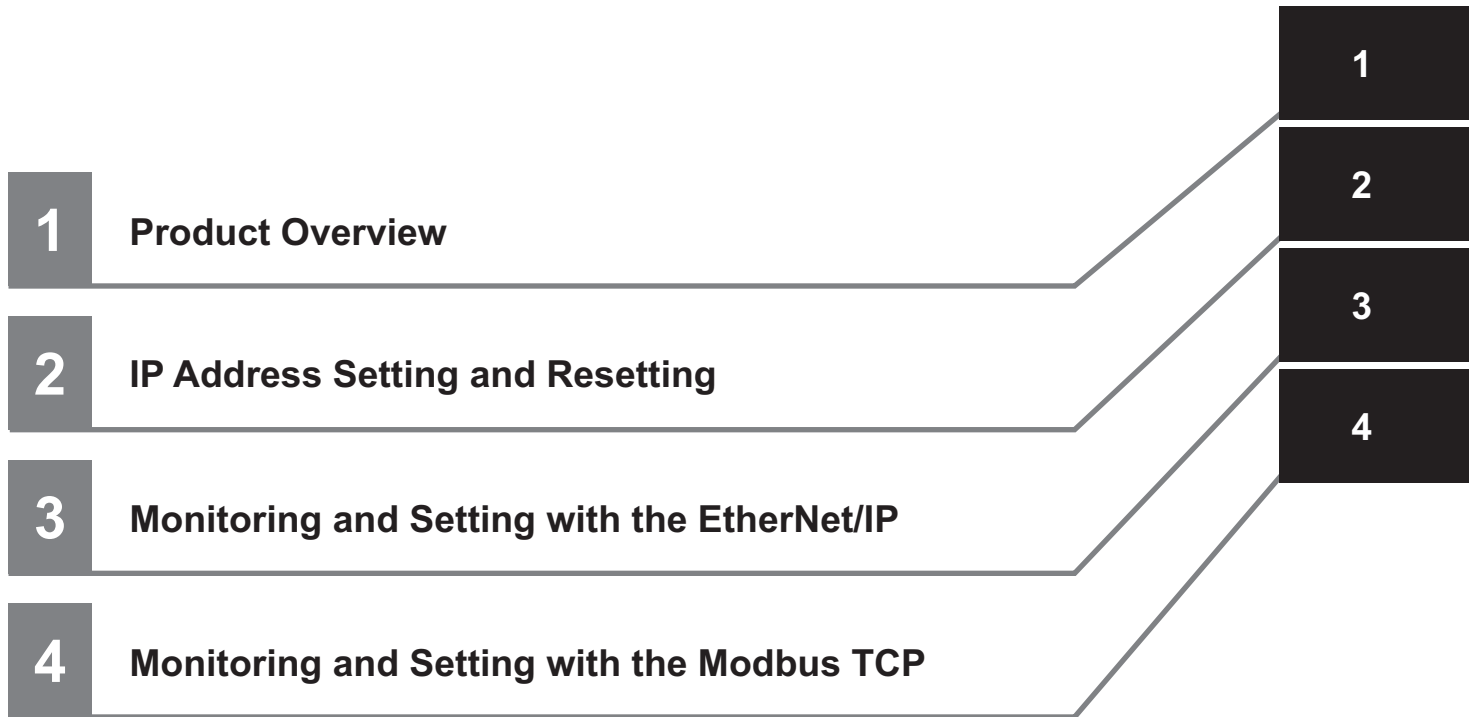

CONTENTS

Preface	1
Terms and Conditions Agreement	2
Warranty, Limitations of Liability	2
Application Considerations	3
Disclaimers	3
Safety Precautions	4
Definition of Precautionary Information.....	4
Symbols	4
Precautions for Correct Use.....	5
Revision History	6
Sections in this Manual	7
CONTENTS.....	8

Section 1 **Product Overview**

1-1 List of Models	1-2
1-2 Nomenclature and Functions	1-3
1-3 Communications Specifications	1-5
1-4 Communications Methods and Types of Data To Be Communicated	1-6
1-5 Measurement and Calculation Data	1-7
1-6 Self-Diagnosis Information	1-8
1-7 Product Information and Communications Setting Data	1-9
1-8 Communications Wiring	1-10
1-9 Procedure	1-12

Section 2 **IP Address Setting and Resetting**

2-1 IP Address Settings	2-2
2-2 Communications Reset Function	2-5

Section 3 **Monitoring and Setting with the EtherNet/IP**

3-1 Overview.....	3-2
3-1-1 What is Monitoring Using EtherNet/IP?.....	3-2
3-1-2 Tag Data Link	3-3
3-1-3 CIP Message Communications.....	3-5
3-2 List of Monitoring Contents Using the Tag Data Link Communications.....	3-6
3-2-1 Connection setting	3-6
3-2-2 Data to be Tag Data Link Target in the S8VK-X	3-6
3-3 List of Monitoring and Setting Contents Using the CIP Message Communications	3-8
3-3-1 Services Supported by Objects in the S8VK-X	3-8
3-3-2 Monitor Object of the S8VK-X (Class ID: 372 hex)	3-8

3-3-3	Setting Object of the S8VK-X (Class ID: 373 hex).....	3-10
3-3-4	Identity Object (Class ID: 01 hex).....	3-11
3-3-5	TCP/IP Interface Object (Class ID: F5 hex).....	3-13
3-3-6	Example of the CIP Message Communications Instruction.....	3-15

Section 4 **Monitoring and Setting with the Modbus TCP**

4-1	Overview.....	4-2
4-2	Function Codes	4-3
4-2-1	Function Code List.....	4-3
4-2-2	03 hex: Reading of multiple registers	4-3
4-2-3	06 hex: Operation command (Resets the peak hold current).....	4-5
4-2-4	10 hex: Writing of multiple registers.....	4-6
4-2-5	Exception Code List.....	4-7
4-3	Register Address Lists.....	4-8
4-3-1	Measurement/calculation data and Self-diagnostic information	4-8
4-3-2	Product Information and Communications Setting Data.....	4-9



Product Overview

This section describes the overview of the S8VK-X.

1-1	List of Models	1-2
1-2	Nomenclature and Functions	1-3
1-3	Communications Specifications	1-5
1-4	Communications Methods and Types of Data To Be Communicated	1-6
1-5	Measurement and Calculation Data	1-7
1-6	Self-Diagnosis Information	1-8
1-7	Product Information and Communications Setting Data	1-9
1-8	Communications Wiring	1-10
1-9	Procedure	1-12

1-1 List of Models

This section shows the model list of the S8VK-X.

The S8VK-X has a type with display monitor and a type without display monitor.

● With Indication Monitor

Power rating	Rated input voltage	Rated output voltage (DC)	Rated output current	Maximum boost current	Model number
90 W	100 to 240 VAC	24 V	3.75 A	---	S8VK-X09024A-EIP
120 W	(allowable range: 85 to 264 VAC, 90 to 350 VDC)	24 V	5 A	6 A	S8VK-X12024A-EIP
240 W		24 V	10 A	15 A	S8VK-X24024A-EIP
480 W		24 V	20 A	30 A	S8VK-X48024A-EIP

● Without Indication Monitor

Power rating	Rated input voltage	Rated output voltage (DC)	Rated output current	Maximum boost current	Model number
30 W	100 to 240 VAC	5 V	5 A ^{*1}	6 A	S8VK-X03005-EIP
60 W	(allowable range: 85 to 264 VAC, 90 to 350 VDC)	12 V	4.5 A ^{*2}	5.4 A	S8VK-X06012-EIP
90 W		24 V	2.5 A	3 A	S8VK-X06024-EIP
		24 V	3.75 A	---	S8VK-X09024-EIP
120 W		24 V	5 A	6 A	S8VK-X12024-EIP
240 W		24 V	10 A	15 A	S8VK-X24024-EIP
480 W		24 V	20 A	30 A	S8VK-X48024-EIP

*1. Output power is 25 W at rated output current.

*2. Output power is 54 W at rated output current.

1-2 Nomenclature and Functions

This section describes the nomenclature and functions of the S8VK-X.

In the following, the position of each part is indicated by number, and its contents are shown in a list.

● With Indication Monitor

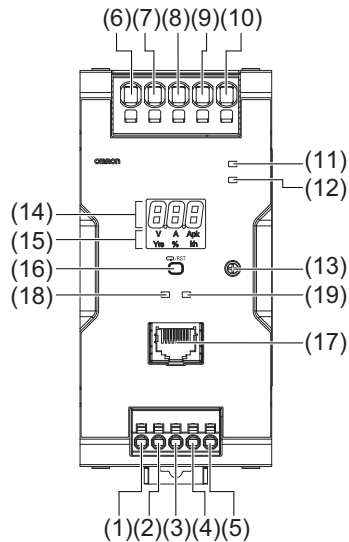

* The above figure shows S8VK-X48024A-EIP.

● Without Indication Monitor

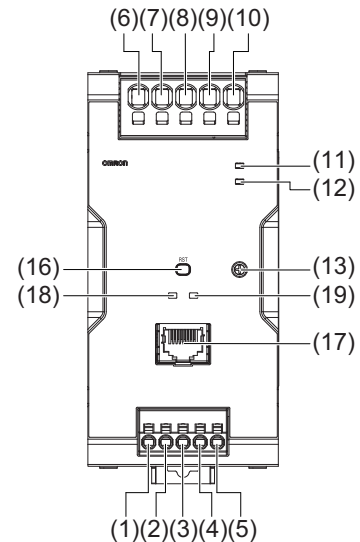

* The above figure shows S8VK-X48024-EIP.

Nomenclature and Functions

No.	Terminal name	Name	Function
(1)	L1	Input terminals	Connect the input lines to these terminals. *1
(2)	L2		
(3)	N1		
(4)	N2		
(5)	PE	Protective Earth terminal (PE)	Connect the ground line to this terminal. *2
(6)	+V1	DC Output terminals	Connect the load lines to these terminals.
(7)	+V2		
(8)	-V1		
(9)	-V2		
(10)	-V3		
(11)	---	Output indicator (DC ON: Green)	The green indicator indicates when a DC voltage is being output.
(12)	---	Alarm indicator (ALM: Red)	Lights up in red when a Power Supply abnormality occurs. Refer to 1-6 Self-Diagnosis Information on page 1-8 for details.
(13)	---	Output voltage adjuster (V. ADJ)	Use to adjust the output voltage.
(14)	---	Main display (white)	Displays measured values.

No.	Terminal name	Name	Function	
(15)	---	Operation indicator (white)	V	Lights up when the output voltage is indicated.
	---		A	Lights up during indication of output current.
	---		Apk	Lights up during indication of peak hold current.
	---		Yrs	Lights up during replacement time calculation year indication.
	---		%	Lights up during years until replacement time indication.
	---		kh	Lights up during percentage until replacement time indication.
(16)	---	Indication switching/reset key (types with indication monitor) Reset key (types without indication monitor)	Used to change the indicated parameter. Used to reset the peak hold current or communication settings. For reset methods, refer to 2-2 <i>Communications Reset Function</i> on page 2-5.	
(17)	---	EtherNet/IP port	Connects to Ethernet cables.	
(18)	---	Module status indicator (MS)	Refer to <i>Module Status and Network Status Indicators</i> on page 1-4 for details.	
(19)	---	Network status indicator (NS)		

*1. The fuse is located on the (L) side. For a DC input, connect the positive voltage to the L terminal.

*2. This is the protective

Module Status and Network Status Indicators

Name	Color	Status	Operating status
Module status Indicator (MS)	Green	Lit	Normal
		Flashing	---
	Red	Lit	RAM abnormality, EEPROM abnormality
		Flashing	Voltage measurement abnormality, current measurement abnormality
	---	Not lit	No power supply
Green/Red	Flashing	When power is turned ON	
Network status Indicator (NS)	Green	Lit	Connection established
		Flashing	Connection not established
	Red	Lit	Multiple IP addresses
		Flashing	Connection timeout BOOTP server connection abnormality
	---	Not lit	No power supply
Green/Red	Flashing	When power is turned ON	

1-3 Communications Specifications

This section shows the communications specifications of the S8VK-X.

Item		Specification
Communications protocol		EtherNet/IP, Modbus TCP
Physical layer		100 BASE-TX
Media access method		CSMA/CD
Modulation system		Baseband
Topology		Star configuration
Transmission speed		100 Mbps
Transmission medium		Twisted pair cable (with shield: STP): Category 5, 5e or above
Maximum transmission distance (distance between hub and node)		100 m
Tag data link^{*1}	Class1	Connection resource: 1 max.
	Number of connected nodes	1
	Number of tag sets	1
	Packet interval (RPI)	100 to 10,000 ms
	Time-out value	Multiple of RPI
	Connection type	Point To Point Connection (fixed)
Explicit message^{*1}	Class3	Number of clients that can communicate at one time: 2 max.
	UCMM	Number of clients that can communicate at one time: 2 max.
Modbus message^{*1}	Modbus TCP	Number of clients that can communicate at one time: 2 max.
Factory default values	IP address	192.168.250.20
	Subnet mask	255.255.255.0
	Default gateway	0.0.0.0
	IP address setting method	Static IP address

*1. When you use tag data link, explicit message communications, and Modbus message communications simultaneously, limit the number of client nodes to 4 or less. If simultaneous communication is carried out with 5 or more nodes, a timeout may occur due to the communications load.

1-4 Communications Methods and Types of Data To Be Communicated

This section shows the communications methods of the S8VK-X and the types of data to be communicated.

You can read or write the communications target data of the S8VK-X using one of the following methods.

For details on the communications methods and target data, refer to the sections shown in the table below.

Communications protocol	Communications methods	Types of data to be communicated		Reference
		<ul style="list-style-type: none"> • Measurement and calculation data ^{*1} • Self-diagnosis Information ^{*2} 	<ul style="list-style-type: none"> • Product information and communications setting data ^{*3} 	
EtherNet/IP	Tag data links	Can read	Can not write	3-2 List of Monitoring Contents Using the Tag Data Link Communications on page 3-6
	CIP message communications		Can write and can read	3-3 List of Monitoring and Setting Contents Using the CIP Message Communications on page 3-8
Modbus TCP	Modbus TCP message communications			Section 4 Monitoring and Setting with the Modbus TCP

*1. Refer to 1-5 Measurement and Calculation Data on page 1-7 below.

*2. Refer to 1-6 Self-Diagnosis Information on page 1-8 below.

*3. Refer to 1-7 Product Information and Communications Setting Data on page 1-9 below.

1-5 Measurement and Calculation Data

This section shows measurement and calculation data that can be read using communications with the S8VK-X.

The following measurement and calculation data can be read using the EtherNet/IP or the Modbus TCP.

Measurement and calculation data	Measurement			EtherNet/IP		Modbus TCP
	Resolution	Data update cycle	Details	Tag data link	CIP message	
Output voltage measured	0.1 V	5 ms	Measurement accuracy: $\pm 2\%$ (percentage of output voltage value) ± 1 digit	Read	Read	Read
Output current measured	0.1 A	5 ms	Measurement accuracy: $\pm 5\%$ (percentage of rated output current) ± 1 digit	Read	Read	Read
Peak hold current measured *1	0.1 A	5 ms	Measurement accuracy: $\pm 5\%$ (percentage of rated output current) ± 1 digit	Read	Read	Read
Years until replacement	0.1 years	1 min	Range: 0.0 to 15.0 years	Read	Read	Read
	FUL *2	---	1 min 1: FUL (<i>FUL</i> displayed at the main display.) 0: other than FUL	Read	Read	Read
	HLF *2	---	1 min 1: HLF (<i>HLF</i> displayed at the main display.) 0: other than FUL	Read	Read	Read
Percentage until replacement	0.1%	1 min	Range: 0.0 to 100%	Read	Read	Read
Total run time	1 h	1 min	Range: 0 to 262,800 h	Read	Read	Read
Continuous run time	1 min	1 min	Range: 0 to 15,768,000 min	Read	Read	Read

*1. Peak hold current measured can be reset. It can be reset by operating the "Peak hold current reset" bit.

*2. It can be checked with "S8VK-X status".

1-6 Self-Diagnosis Information

This section shows status information that can be confirmed by the self-diagnosis of the S8VK-X.

The following self-diagnosis status can be checked with the "S8VK-X status" using the EtherNet/IP or the Modbus TCP.

Status name		Details	Restoration method	Main display	Alarm indicator	EtherNet/IP		Modbus TCP
						Tag data link	CIP message	
Measurement abnormality	Current measurement error	Output voltage, output current, etc., cannot be measured normally due to noise.	Automatic restoration	---	Lit	Read	Read	Read
	Voltage measurement error					Read	Read	Read
Overheating alarm		Overheated status has continued for 1 to 180 minutes.	Automatic restoration	H \bar{a} t (Flashing)	Lit	Read	Read	Read
Product overheat abnormality		Overheated status has continued for more than 180 minutes.	Replace the S8VK-X, as internal parts may be deteriorated.	E06 (Flashing)	Lit	Read	Read	Read
Memory error		An error has occurred in the internal memory and data damage has occurred.	Turn the AC input OFF then ON again. If the S8VK-X is not reset, contact the dealer.	E03	Lit	Read	Read	Read

Note 1. The cause of the " - - - " and "E03" display may be the noise from outside.

- When "E03" is displayed, the display can not be switched.
- The causes of "H \bar{a} t" and "E06" display may include use in conditions exceeding the derating curve, ventilation error, or an error in the installation direction.
- When you press the Indication switching/reset key with "H \bar{a} t" or "E06" displayed, the display will return to the normal display.
- When "E06" is displayed, the display of the number of years and percentages until the replacement time will be 0.0 years and 0.0%, respectively.

1-7 Product Information and Communications Setting Data

This section shows product information and communications setting data that can be read or written using communications with the S8VK-X.

The following product information and communications setting data can be read or written using the EtherNet/IP or the Modbus TCP.

Name	Factory default	EtherNet/IP		Modbus TCP
		Tag data link	CIP message	
Product model	---	None	Read	Read
Serial number	---	None	Read	Read
Firmware version	---	None	Read	Read
MAC address	---	None	Read	Read
IP address	192.168.250.20	None	Read/Write	Read/Write
Subnet mask	255.255.255.0	None	Read/Write	Read/Write
Default gateway	0.0.0.0	None	Read/Write	Read/Write

1-8 Communications Wiring

This section describes the communications wiring of the S8VK-X.

Connect the S8VK-X with the host devices such as PLC or PC via the industrial switching hub with the Ethernet cables. For the communications cables and industrial switching hubs, use the recommended items shown on the next page.

Host device: PLC, PC, etc.

- EtherNet / IP supported

Or

- Modbus TCP supported

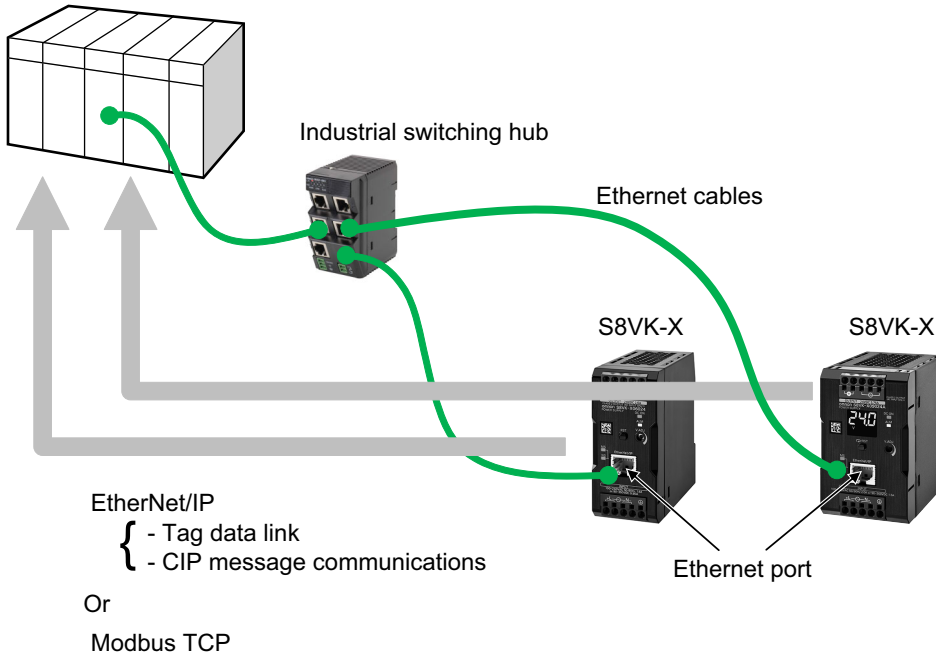



Recommended EtherNet/IP Communication Cables (Order Separately)

Use an STP cable (shielded twisted pair cable) of Category 5 or above.

Part name	Manufacturer	Model number	Contact Information
Cable	Hitachi Metals, Ltd.	NETSTAR-C5E SA 0.5×4P *1	Kanetsu Co., Ltd., Planning Department TEL: +81 (0)75-662-0996
RJ45 connector	Panduit Corp.	MPS588-C *1	Panduit Corp. Japan Branch, Osaka Office

*1. We recommend use of these cables and connectors in the above combinations.

Recommended Industrial Switching Hubs (Order Separately)

Name	Shape	Specification			Model number
		Functions	Number of ports	Failure detection function	
Industrial switching hub		Priority control (QoS): EtherNet/IP control data priority	3	No	W4S1-03B
		Failure detection: Broadcast storm/ LSI abnormality detection 10/100BASE-TX, Auto-Negotiation	5	No	W4S1-05B
			5	Yes	W4S1-05C

1-9 Procedure

The S8VK-X can be used in the following procedure.

Step	Procedures	Reference			
1. Installation and Wiring	Install. ↓ Wire.	1-2 Nomenclature and Functions on page 1-3 ---			
2. IP address setting of S8VK-X	Install the Network Configurator ↓ Start the Network Configurator ↓ <table border="1" data-bbox="481 763 1115 898"> <tr> <td data-bbox="481 763 911 831">Connect the PC to the S8VK-X via Ethernet cable.</td> <td data-bbox="911 763 1115 898" rowspan="2">Either order is acceptable.</td> </tr> <tr> <td data-bbox="481 831 911 898">Turn on the input power to the S8VK-X</td> </tr> </table> ↓ From the Network Configurator, set the IP address of the S8VK-X	Connect the PC to the S8VK-X via Ethernet cable.	Either order is acceptable.	Turn on the input power to the S8VK-X	Section 2 IP Address Setting and Resetting
Connect the PC to the S8VK-X via Ethernet cable.	Either order is acceptable.				
Turn on the input power to the S8VK-X					
3. Monitoring from the host	Connect from the host (PLC, PC, etc.) to the S8VK-X ↓ Set up communications for host (PLC, PC, etc.) or create and download a communications program. ↓ The host (PLC, PC, etc.) reads the state of the S8VK-X using EtherNet/IP (tag data link or CIP message communications) or Modbus TCP. ↓ Monitoring the S8VK-X	Section 3 Monitoring and Setting with the EtherNet/IP or Section 4 Monitoring and Setting with the Modbus TCP			
4. Operation	<ul style="list-style-type: none"> • Obtain and periodically manage the S8VK-X's replace time, output voltage, output current, etc. via communications. • Check the abnormal state of the S8VK-X with the self-diagnosis functions, and then take action. 	---			

2

IP Address Setting and Resetting

This section describes the setting and resetting of the IP address of the S8VK-X.

2-1	IP Address Settings	2-2
2-2	Communications Reset Function	2-5

2-1 IP Address Settings

Set the IP address of the S8VK-X using the Network Configurator.

Alternatively, you can set the IP address using the Power Supply Monitoring Tool, which can be downloaded from our website. For details, refer to the *Power Supply Monitoring Tool Operation Manual* (Cat No. T215).

Setting the IP Address of the S8VK-X from the Network Configurator

1 Start the Network Configurator.

Select the [Network Configurator] from the [Start] - [All Programs] - [OMRON] - [Sysmac Studio] - [Network Configurator for EtherNet/IP] to start the Network Configurator.

The following window will be displayed when the Network Configurator starts.

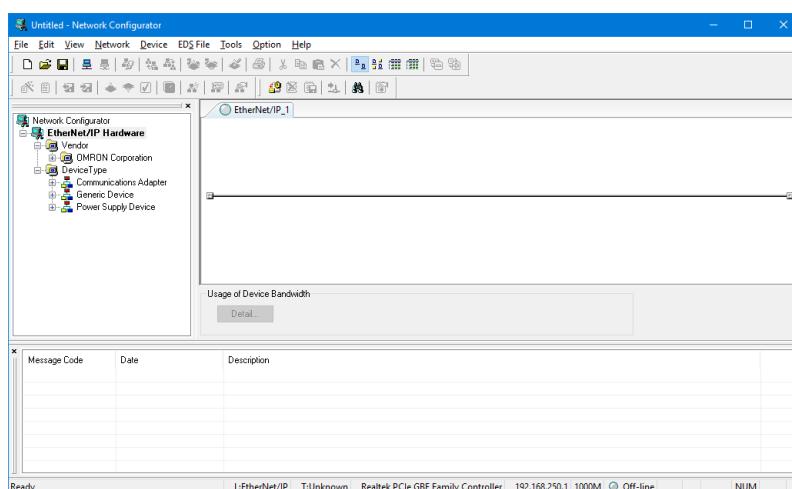

2 Connect the Network Configurator via Ethernet.

(1) Select the [Ethernet I/F] from [Option] - [Select Interface].

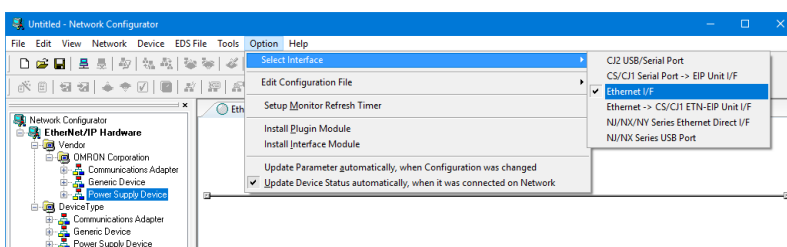

(2) Select the [Connect] from [Network].

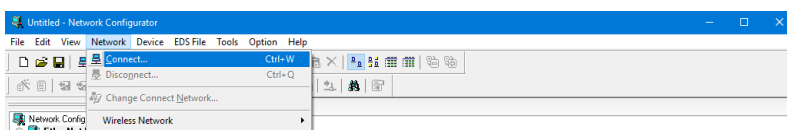

3 Set the IP address of the S8VK-X.

Select the [Setup TCP/IP Configuration] from the [Tools] to open the [Setup TCP/IP Configuration] Dialog Box.

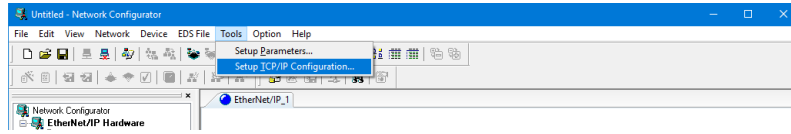

Enter "192.168.250.20", which is the default IP address of the S8VK-X, in the [Target IP Address] Box.

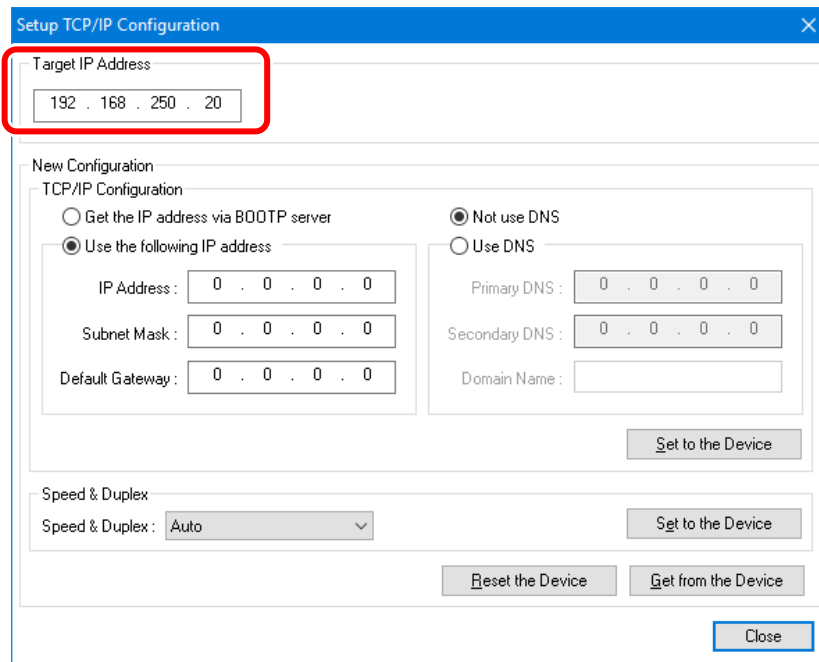

● Setting a Fixed IP Address

1. Enter the IP address, subnet mask, and default gateway.
2. Click the [Set to the Device] Button.
3. Click the [Reset the Device] Button to apply the IP address setting in the S8VK-X.

The screenshot shows the 'Setup TCP/IP Configuration' dialog box. The 'Target IP Address' field contains '192 . 168 . 250 . 20'. Under 'New Configuration', the 'TCP/IP Configuration' section has three radio buttons: 'Get the IP address via BOOTP server' (unselected), 'Use the following IP address' (selected), and 'Not use DNS' (selected). The 'Use the following IP address' section contains three input fields: 'IP Address' (192 . 168 . 250 . 21), 'Subnet Mask' (0 . 0 . 0 . 0), and 'Default Gateway' (0 . 0 . 0 . 0). To the right, there are 'Primary DNS' and 'Secondary DNS' fields (both 0 . 0 . 0 . 0) and a 'Domain Name' field. At the bottom, there is a 'Speed & Duplex' section with a dropdown set to 'Auto'. Three red boxes highlight the 'Set to the Device' button (labeled 2), the 'Reset the Device' button (labeled 3), and the IP address input fields (labeled 1). A 'Close' button is at the bottom right.

● Getting an IP Address from a BOOTP Server

1. Select the [Get the IP Address via BOOTP server] Option.
2. Click the [Set to the Device] Button.
3. Click the [Reset the Device] Button to apply the IP address setting in the S8VK-X.

The screenshot shows the 'Setup TCP/IP Configuration' dialog box. The 'Target IP Address' field contains '192 . 168 . 250 . 20'. Under 'New Configuration', the 'TCP/IP Configuration' section has three radio buttons: 'Get the IP address via BOOTP server' (selected), 'Use the following IP address' (unselected), and 'Not use DNS' (selected). The 'Get the IP address via BOOTP server' section contains three input fields: 'IP Address' (0 . 0 . 0 . 0), 'Subnet Mask' (0 . 0 . 0 . 0), and 'Default Gateway' (0 . 0 . 0 . 0). To the right, there are 'Primary DNS' and 'Secondary DNS' fields (both 0 . 0 . 0 . 0) and a 'Domain Name' field. At the bottom, there is a 'Speed & Duplex' section with a dropdown set to 'Auto'. Three red boxes highlight the 'Set to the Device' button (labeled 2), the 'Reset the Device' button (labeled 3), and the 'Get the IP address via BOOTP server' radio button (labeled 1). A 'Close' button is at the bottom right.

2-2 Communications Reset Function

This section describes the communications reset function of the S8VK-X.

This function temporarily resets the communications settings to their factory default values. Use this function when the IP address previously set is no longer known and communication is not possible.

The setting method is as follows.

- 1** With the reset key pressed, turn ON the power supply.
- 2** Continue to hold the reset key for 10 seconds. While pressed, an alarm indicator will flash in 0.5-second intervals. (For models with an indication monitor, the main display and operation indicator will also repeatedly turn all indicators on and off in 0.5-second intervals.)
- 3** After 10 seconds have elapsed, the system shifts into the communication reset state, and the communications setting values temporarily reset to their factory default values. In the communications reset state, the alarm indicator will flash in 1-second intervals. (For models with an indication monitor, the main display and operation indicator will return to normal operation.)
- 4** In the communications reset state, reset the communications settings from the host device.
- 5** After setting, turn ON the power supply once again, and confirm that the set values have been changed.

- Note 1. After confirming that the product output indicator has turned off, turn ON the power supply once again.
2. The only way to exit the communications reset state is to restart the power supply.
 3. If you do not change the communications settings during step 4, settings will return to their prior values once the communications reset is ended.

3

Monitoring and Setting with the EtherNet/IP

This section describes how to monitor and configure the S8VK-X using the EtherNet/IP.

3-1 Overview	3-2
3-1-1 What is Monitoring Using EtherNet/IP?	3-2
3-1-2 Tag Data Link	3-3
3-1-3 CIP Message Communications	3-5
3-2 List of Monitoring Contents Using the Tag Data Link Communications	3-6
3-2-1 Connection setting	3-6
3-2-2 Data to be Tag Data Link Target in the S8VK-X	3-6
3-3 List of Monitoring and Setting Contents Using the CIP Message Communications	3-8
3-3-1 Services Supported by Objects in the S8VK-X	3-8
3-3-2 Monitor Object of the S8VK-X (Class ID: 372 hex)	3-8
3-3-3 Setting Object of the S8VK-X (Class ID: 373 hex)	3-10
3-3-4 Identity Object (Class ID: 01 hex)	3-11
3-3-5 TCP/IP Interface Object (Class ID: F5 hex)	3-13
3-3-6 Example of the CIP Message Communications Instruction	3-15

3-1 Overview

This section describes how to monitor the S8VK-X using the EtherNet/IP.

3-1-1 What is Monitoring Using EtherNet/IP?

The S8VK-X can be monitored from host devices such as PC and PLC via EtherNet/IP.

The following two communications methods can be used.

Communications method	Outline	For the S8VK-X	
		Monitoring	Settings
Tag data link	This is a method of exchanging data in preset areas cyclically (at regular intervals). Communication instructions are not used.	Supported	Not supported
CIP message communications	This is a method of accessing specified data when necessary. Use the communications instructions.	Supported	Supported

Note that EtherNet/IP enables simultaneous execution of these two types of communication methods.

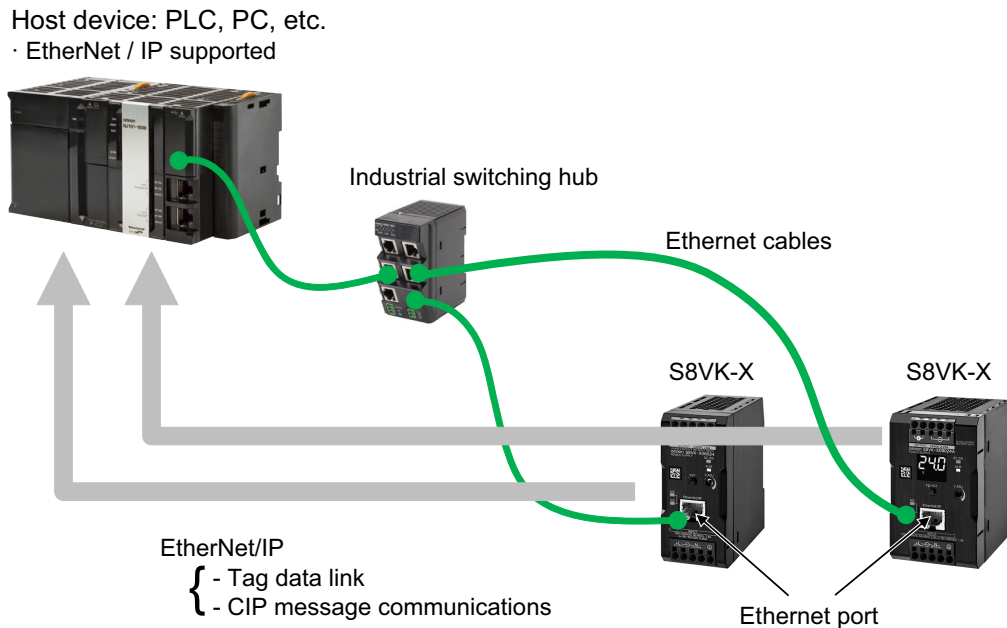

If the S8VK-X was manufactured before February 28, 2019, a tag data link timeout may occur in the network system including the node configured for multicast communications. Use a switching hub with multicast filtering function to prevent multicast packets from reaching S8VK-X.

The date of manufacturing can be checked by lot number. The lot number is indicated on the label of the product body and the individual box.

How to read the lot number on the label.

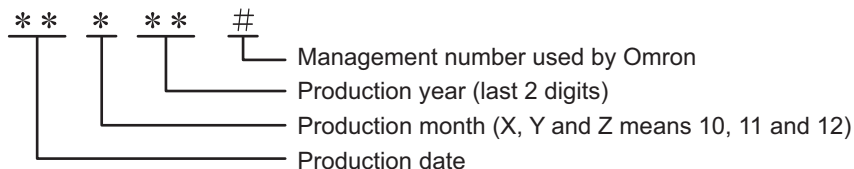

3-1-2 Tag Data Link

The current values of S8VK-X are sent cyclically to the specified area of the PLC.

- The PLC assigns I/O memory address or variables to the input tag set. The size must be the same as the internal data size of the S8VK-X.
- The S8VK-X assigns an identification number (instance ID) of a predetermined tag data link internal data to the output tag set. The data size is fixed to 20 bytes (common to models).

● Configuration tool

When configuring with OMRON controllers, the following setting tools for the tag data link should be used.

Configurations	Tag data link setting tool (configuration tool) to be used
When tag data link is made between CJ-series PLCs or other company PLCs and the S8VK-X	Network Configurator
When tag data link is made between NJ/NX-series Controller and the S8VK-X	Network Configurator or Sysmac Studio

● Connection to be created

- Network Configurator

1

Install and start

- (1) Install Network Configurator.
- (2) Start Network Configurator.
- (3) Download the S8VK-X EDS file from our I-Web and install it on the Network Configurator.

2

Configuration

- (1) Register PLC and S8VK-X in the network configuration and set the IP address.
- (2) Configure settings to add a connection between devices (i.e., "make a connection").

Note. Things to check beforehand:

- Which memory area (I/O memory or variables) in the PLC should be used for the tag data link.
- The size of the internal data (parameter) of the S8VK-X is 20 bytes for all models

- 2) -1 Drag a S8VK-X to the PLC and register it.
- 2) -2 Click the [Edit Tag Sets] Button to create input tags with the above sizes.
- 2) -3 Register the input tag as it is as input tag set.
- 2) -4 Select the input tag set created in 2) -3 above from the pull-down list.
- 2) -5 Register the connection.

Connection assignment dialog to S8VK-X

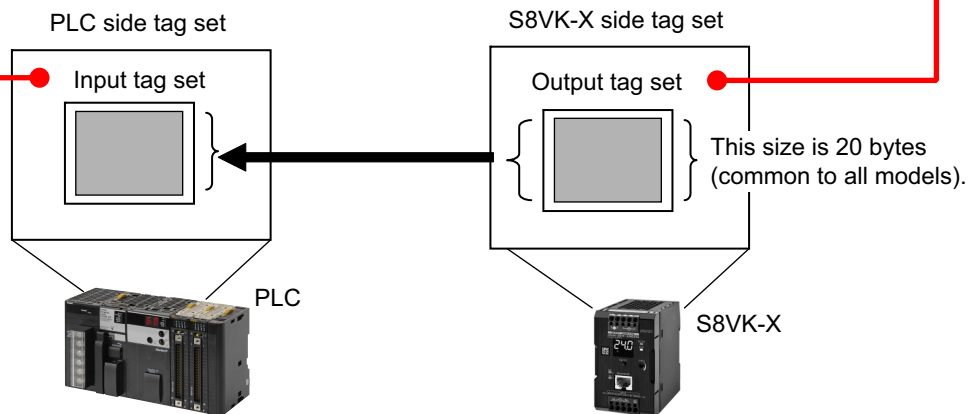
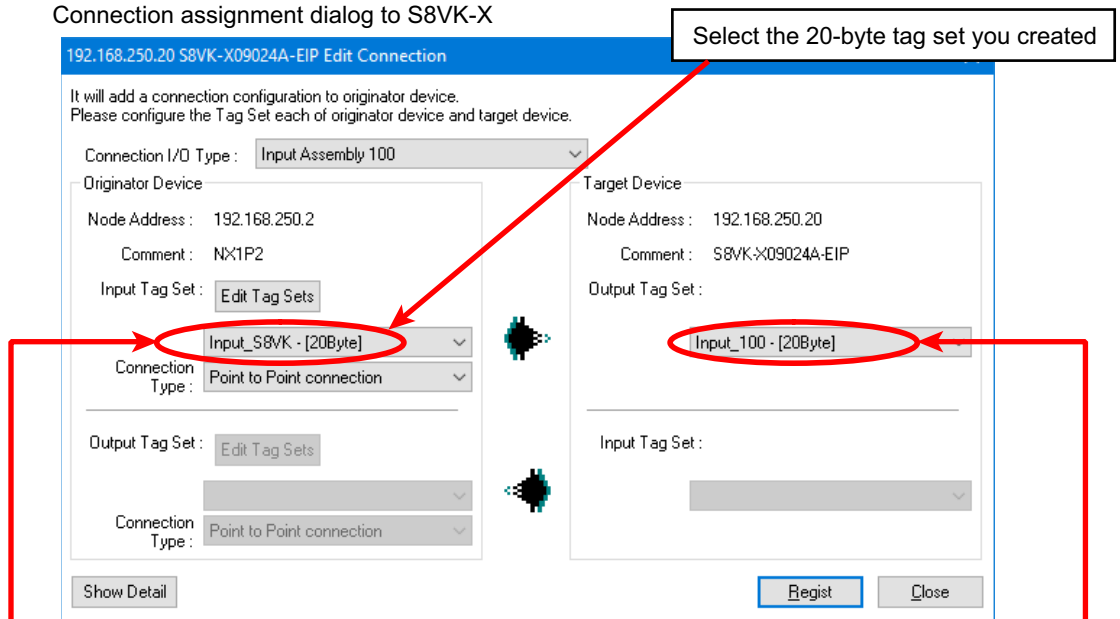

Create a tag that matches the size of the internal data of type S8VK-X 20 bytes (common to all models), and sets it as the input tag set as it is.

Leave the output tag set name "Input_100 - [20 Bytes]" displayed.

- 3** Download the connections that were set to the PLC.
Tag data link communications are automatically started.
- 4** Confirm each LED of the PLC and the S8VK-X, and status information in the [Device Monitor] Dialog Box of the Network Configurator.

- Sysmac Studio

- 1** Select [EtherNet/IP connection settings] from the [Tools] menu.
- 2** Right-click on the target device list in the tool box on the EtherNet/IP connection settings Tab page and select the [Display EDS Library] menu.
- 3** Click the [Install] Button and import the EDS file of each S8VK-X in the [EDS Library] Dialog Box.
- 4** Click  [Add device] Button in [Toolbox] and select the S8VK-X in the [Built-in EtherNet/IP Port Settings Connection] Tab page.
- 5** Select the S8VK-X that has been added from the pull-down list in the [Target Device] column in "▼Connection" list in the Connection Tab Page of PLC side (i.e., originator side).

- 6 In the [Target Variable] column, press the [Ctrl] and [Space] keys at the same time and the available identification numbers are displayed on the pull down list, so select the identification number to use.

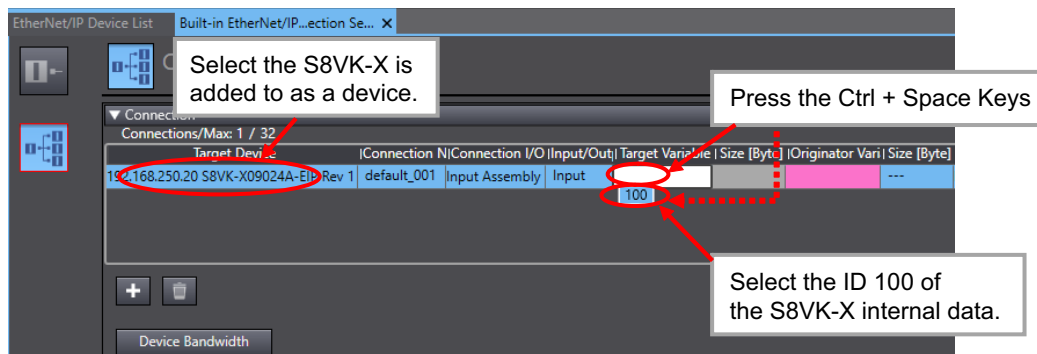

When you select an identification number, the size is automatically entered synchronously.

- 7 In the [Originator Variable] column, select the global variable of the NJ/NX-series CPU Unit. (Beforehand, it is necessary to register global variables whose network publish attribute is "Input" or "Output" in the global variable table.)

3-1-3 CIP Message Communications

Any CIP command can be issued to the S8VK-X on the EtherNet/IP network from CIP clients such as PC (supporting the EtherNet /IP) or NJ/NX-series Controller using the Explicit messages. This allows you to perform various processing such as data reading and writing of the S8VK-X.

● Communications Instructions

When sending a CIP command with Explicit messages from OMRON PLCs or Controllers, use the following communications Instruction.

Controller	Communications Instruction
CJ-series PLC	Explicit message send commands (2810 hex) for CIP routing are issued by CMND instructions
NJ/NX-series Controller	CIPSend (Send Explicit Message Class 3) instruction Or CIPUCMMSend (Send Explicit Message UCMM) instruction

3-2 List of Monitoring Contents Using the Tag Data Link Communications

This section describes contents to be monitored using tag data link communication.

3-2-1 Connection setting

Setting items		Setting contents
Originator device (PLC)	Input tag set	Specify the tag set on the PLC side of 20 bytes
	Connection type	Specify "Point to Point connection".
Target device (S8VK-X)	Output tag set	Instance ID: 100, size is fixed to 20 bytes.
	Connection type	Specify "Point to Point connection".
Packet interval (RPI)		Any (default: 100 ms)
Timeout value		User specified (default: Packet interval (RPI) × 4)



Precautions for Correct Use

If memory addresses are specified for the communications areas, the information in the communications areas will be cleared when the operating mode of the PLC changes unless addresses in the Area, which are maintained, are specified.

3-2-2 Data to be Tag Data Link Target in the S8VK-X

Identification Number and Size of Internal Data to be Tag Data Link

The identification number (the instance ID of the Assembly object) and the size of internal data (Assembly object) to be tag data link target in the S8VK-X are as follows.

Identification number (Instance ID of Assembly object)	Size	Direction of data
100	20 bytes common to all models	Target (S8VK-X) → Originator (such as PLC)

List of Internal Data to be Tag Data Link

The tag data link target data in the S8VK-X is shown below.

● Memory allocation

Word	Bit	15	14	13	12	11	10	9	8	7	6	5	4	3	2	1	0
+0		S8VK-X status															
+1		Output voltage measured															
+2		Output current measured															
+3		Peak hold current measured															
+4		Years until replacement															
+5		Percentage until replacement															
+6		Total run time (lower)															

Word	Bit	15	14	13	12	11	10	9	8	7	6	5	4	3	2	1	0
+7	Total run time (upper)																
+8	Continuous run time (lower)																
+9	Continuous run time (upper)																

● Data contents

Starting Word Address	Parameter name	Data range	Meaning of the value	Size
+0	S8VK-X status	0000 to 000F hex	Status of S8VK-X *1	1 word
+1	Output voltage measured	0000 to 2706 hex (Decimal 0 to 9990)	0.00 to 99.90 V (0.10 V increments) *2	1 word
+2	Output current measured	0000 to 2706 hex (Decimal 0 to 9990)	0.00 to 99.90 A (0.10 A increments) *2	1 word
+3	Peak hold current measured	0000 to 2706 hex (Decimal 0 to 9990)	0.00 to 99.90 A (0.10 A increments) *2	1 word
+4	Years until replacement	0000 to 5DC0 hex (Decimal 0 to 1500)	0 to 150.0 years (0.1 year increments)	1 word
+5	Percentage until replacement	0000 to 3E8 hex (Decimal 0 to 1000)	0.0 to 100.0% (0.1% increments)	1 word
+6	Total run time	0000 to 40290 hex (Decimal 0 to 262800)	0 to 262,800 hours (1 hour increments)	2 word
+8	Continuous run time	0000 to F09C0 hex (Decimal 0 to 15768000)	0 to 15,768,000 minutes (1 minute increments)	2 word

*1. S8VK-X status

Bit position	Status	Bit contents	
		0	1
0	Memory error	Not occurred	Occurrence
1	Product overheat abnormality	Not occurred	Occurrence
2	Current measurement error	Not occurred	Occurrence
3	Voltage measurement error	Not occurred	Occurrence
4	Overheating alarm	Not occurred	Occurrence
5	Reserved	-	-
6	Reserved	-	-
7	Reserved	-	-
8	Years until the replacement reached FUL	Other than FUL	FUL
9	Years until the replacement reached HLF	Other than HLF	HLF
10	Reserved	-	-
11	Reserved	-	-
12	Reserved	-	-
13	Reserved	-	-
14	Reserved	-	-
15	Reserved	-	-

*2. · The maximum value depends on the model type.

· The least significant digit of the value regarded as a decimal number is fixed to 0.

3-3 List of Monitoring and Setting Contents Using the CIP Message Communications

This section shows the contents of monitoring and setting using the CIP message communications and examples of communications instructions.

3-3-1 Services Supported by Objects in the S8VK-X

The services supported by the objects in the S8VK-X are as follows.

Object name	Class ID	Function
Monitor object of the S8VK-X	372 hex	Reads the measurement value of the S8VK-X and other current values.
Setting object of the S8VK-X	373 hex	Instructs operation to the S8VK-X.

3-3-2 Monitor Object of the S8VK-X (Class ID: 372 hex)

This object reads the current values of the S8VK-X.

Service Codes

Service Codes	Service name	Description	Supported services	
			Classes	Instances
01 hex	Get_Attributes_All	Reads the values of all attributes.	Not supported.	Supported.
0E hex	Get_Attribute_Single	Reads the value of the specified attribute.	Not supported.	Supported.

Class ID

Specify 372 hex.

Instance ID

Specify 01 hex.

Attribute ID

Attribute ID	Parameter name	Data range	Meaning of the value	Attribute	Read data	
					Data type	Default value
64 hex	S8VK-X status	0000 to 000F hex	Status of S8VK-X *1	Read	UINT	0
65 hex	Output voltage measured	0000 to 2706 hex (Decimal 0 to 9990)	0.00 to 99.90 V (0.10 V increments) *2	Read	UINT	0
66 hex	Output current measured	0000 to 2706 hex (Decimal 0 to 9990)	0.00 to 99.90 A (0.10 A increments) *2	Read	UINT	0
67 hex	Peak hold current measured	0000 to 2706 hex (Decimal 0 to 9990)	0.00 to 99.90 A (0.10 A increments) *2	Read	UINT	0
68 hex	Years until replacement	0000 to 5DC0 hex (Decimal 0 to 1500)	0 to 150.0 years (0.1 year increments)	Read	UINT	0
69 hex	Percentage until replacement	0000 to 3E8 hex (Decimal 0 to 1000)	0.0 to 100.0% (0.1% increments)	Read	UINT	0
6A hex	Total run time	0000 to 40290 hex (Decimal 0 to 262800)	0 to 262,800 hours (1 hour increments)	Read	DWORD	0
6B hex	Continuous run time	0000 to F099C0 hex (Decimal 0 to 15768000)	0 to 15,768,000 minutes (1 minute increments)	Read	DWORD	0

*1. S8VK-X status

Bit position	Status	Bit contents	
		0	1
0	Memory error	Not occurred	Occurrence
1	Product overheat abnormality	Not occurred	Occurrence
2	Current measurement error	Not occurred	Occurrence
3	Voltage measurement error	Not occurred	Occurrence
4	Overheating alarm	Not occurred	Occurrence
5	Reserved	-	-
6	Reserved	-	-
7	Reserved	-	-
8	Years until the replacement reached FUL	Other than FUL	FUL
9	Years until the replacement reached HLF	Other than HLF	HLF
10	Reserved	-	-
11	Reserved	-	-
12	Reserved	-	-
13	Reserved	-	-
14	Reserved	-	-
15	Reserved	-	-

*2. · The maximum value depends on the model type.

· The least significant digit of the value regarded as a decimal number is fixed to 0.

3-3-3 Setting Object of the S8VK-X (Class ID: 373 hex)

Service Codes

Service Codes	Service name	Description	Supported services	
			Classes	Instances
10 hex	Set_Attribute_Single	Write the value of the specified attribute.	Not supported.	Supported.
01 hex	Get_Attributes_All	Reads the values of all attributes.	Not supported.	Supported.
0E hex	Get_Attribute_Single	Reads the value of the specified attribute.	Not supported.	Supported.

Class ID

Specify 373 hex.

Instance ID

Specify 01 hex.

Attribute ID

Attribute ID	Parameter name	Description	Attribute	Read data	
				Data type	Default value
64 hex	Peak hold current reset bit	Resets peak hold current to 0. Rising from 0 to 1: Reset	Write	UINT	0

3-3-4 Identity Object (Class ID: 01 hex)

This object reads the identification information of the S8VK-X, reads the state of the built-in EtherNet/IP port.

Service Codes

Service Codes	Service name	Description	Supported services	
			Classes	Instances
01 hex	Get_Attributes_All	Reads the values of all attributes.	Supported.	Supported.
0E hex	Get_Attribute_Single	Reads the value of the specified attribute.	Supported.	Supported.

Class ID

Specify 01 hex.

Instance ID

Specify 01 hex.

Attribute ID

The attribute ID specifies the information to read.

● Class Attribute ID

The class attribute ID specifies the attribute of the object class.

Attribute ID	Parameter name	Description	Attribute	Data	
				Data type	Default value
01 hex	Revision	Revision of the object	Read	UINT	0001 hex

● Instance Attribute ID

The instance attribute ID specifies the per-instance attribute.

Attribute ID	Parameter name	Description	Attribute	Data	
				Data type	Default value
01 hex	Vendor ID	Vendor ID	Read	UINT	002F hex
02 hex	Device Type	Device type	Read	UINT	0302 hex
03 hex	Product Code	Product Codes	Read	UINT	For details, refer to "1 Product Codes".
04 hex	Revision	Device revision (Match with EIP soft version)	Read	Struct of	-
	Major Revision	Major revision	Read	USINT	1
	Minor Revision	Minor revision	Read	USINT	1
05 hex	Status	Status of the EtherNet/IP Port For details, refer to "2. Status of the EtherNet/IP Port".	Read	WORD	-

Attribute ID	Parameter name	Description	Attribute	Data	
				Data type	Default value
06 hex	Serial Number	Serial number	Read	UDINT	Product specific
07 hex	Product Name	Product name	Read	SHORT_STRING	Product specific

*1. Product Codes

Model	Product Codes
S8VK-X09024A-EIP	068F hex
S8VK-X12024A-EIP	0690 hex
S8VK-X24024A-EIP	0691 hex
S8VK-X48024A-EIP	0692 hex
S8VK-X03005-EIP	0693 hex
S8VK-X06012-EIP	0694 hex
S8VK-X06024-EIP	0695 hex
S8VK-X09024-EIP	0696 hex
S8VK-X12024-EIP	0697 hex
S8VK-X24024-EIP	0698 hex
S8VK-X48024-EIP	0699 hex

*2. Status of the EtherNet/IP Port

Bit	Name	Description
0	Owned	Indicates when the built-in EtherNet/IP port has an open connection as the target of a tag data link.
1	Reserved	Always FALSE.
2	Configured	Tag data link settings exist.
3	Reserved	Always FALSE.
4 to 7	Extended Device Status	Indicates the status of the built-in EtherNet/IP port. 0: Not used 1: Not used 2: One or more I/O connection failures 3: I/O connection is not established 4: Not used 5: Serious defect occurred (MS Criticality) 6: One or more I/O connections are established and one or more are in the RUN state 7: One or more I/O connections are established and all are idle 8 to 15: Unused
8	Minor Recoverable Fault	Always FALSE.
9	Minor Unrecoverable Fault	Always FALSE.
10	Major Recoverable Fault	When the MS indicator matches conditions of the flashing red: True
11	Major Unrecoverable Fault	When the MS indicator matches conditions of the flashing red: True
12 to 15	Reserved	Always FALSE.

3-3-5 TCP/IP Interface Object (Class ID: F5 hex)

This object is used to read and write settings such as the IP address, subnet mask, and default gateway.

Service Codes

Service Codes	Service name	Description	Supported services	
			Classes	Instances
01 hex	Get_Attribute_All	Reads the values of all attributes.	Not supported.	Supported.
0E hex	Get_Attribute_Single	Reads the value of the specified attribute.	Supported.	Supported.
10 hex	Set_Attribute_Single	Write the value of the specified attribute.	Not supported.	Supported.

Class ID

Specify F5 hex.

Instance ID

Specify 01 hex.

Attribute ID

The attribute ID specifies the information to read.

● Class Attribute ID

The class attribute ID specifies the attribute of the object class.

Attribute ID	Parameter name	Description	Attribute	Data	
				Data type	Value
01 hex	Revision	Revision of the object	Read	UINT	0004 hex

● Instance Attribute ID

The instance attribute ID specifies the per-instance attribute.

Attribute ID	Parameter name	Description	Attribute	Data	
				Data type	Default value
01 hex	Interface Configuration Status	Indicates the IP address settings status of the interface.	Read	DWORD	Bits 0 to 3: Interface Configuration Status: 0 = IP address is not set. (This includes when BOOTP is starting.) 1 = IP address is set. Bits 4 to 31: Reserved (always FALSE)

Attribute ID	Parameter name	Description	Attribute	Data	
				Data type	Default value
02 hex	Configuration Capability	Indicates a Setup that can be set to the built-in interface.	Read	DWORD	Bit 0: BOOTP Client: Always TRUE. Bit 1: DNS Client: Always FALSE. Bit 2: DHCP Client: Always FALSE. Bit 3: DHCP-DNS Update: Always FALSE. Bit 4: Configuration Settable: Always TRUE. Bit 5: Hardware Configurable: Always FALSE. Bit 6: Interface Configuration Change Requires Reset: Always TRUE. Bit 7: ACD Capable:*1 Always FALSE. Bits 8 to 31: Reserved (always FALSE).
03 hex	Configuration Control	Sets the method used to set the IP address when the interface starts.	Write	DWORD	00000000 hex: Static IP address. 00000001 hex: Set by BOOTP.
04 hex	Physical Link Object	The path to the link object in the physical layer.	Read	Struct of	-
	Path size	Path size (WORD size)		UINT	0002 hex
	Path	The path to the link object in the physical layer (static).		EPATH	20F6 2401 hex
05 hex	Interface Configuration	The built-in EtherNet/IP port settings.	Write	Struct of	-
	IP Address	IP Address		UDINT	Set value (Factory default: 192.168.250.20)
	Network Mask	Subnet mask.		UDINT	Set value
	Gateway Address	The default gateway.		UDINT	Set value
	Nama Server	The primary name server.		UDINT	Set value
	Nama Server2	The secondary name server.		UDINT	Set value
	Domain Name	The domain name.		STRING	Set value
06 hex	Host Name	The host name (reserved).	Write	STRING	Always 0000 hex.
0D hex	Encapsulation Inactivity Timeout	Encapsulation session timeout time	Write	UINT	0001 to 0E10 hex: 1 to 3600 seconds (0: Disabled) Default 0078 hex (120 seconds)

3-3-6 Example of the CIP Message Communications Instruction

The following shows an example of reading data in the S8VK-X from the NJ/NX-series Controller using the CIP message communications instruction.

Example: Reading of output voltage measured

Send the following CIP message.

- Service code: 16#0E (Get_Attribute_Single: read the value of the specified attribute)
- Class ID: 372 hex
- Instance ID: 01 hex
- Attribute ID: 65 hex (Output voltage measured)

The CIPUCMMSend instruction sends the command data "ServiceDat" as a UCMM message corresponding to the service specified by the "ServiceCode".

The destination is specified by the route path "RoutePath". The request path is specified by "RqPath".

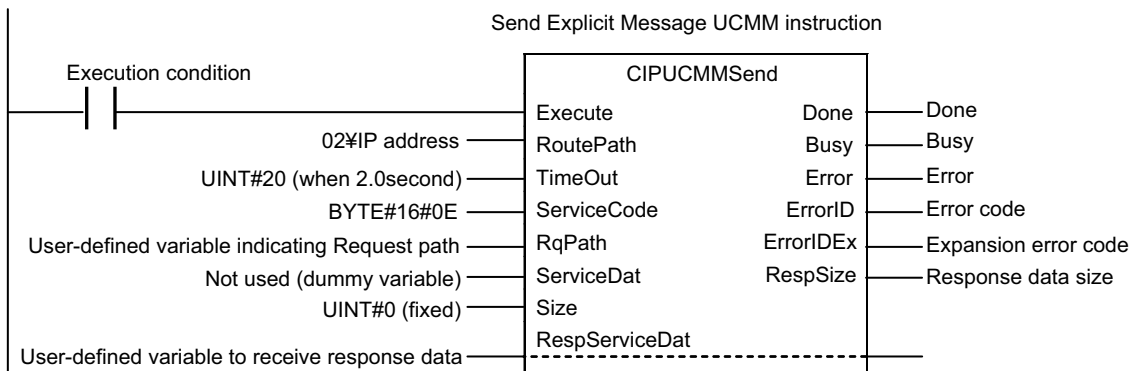

Set the following value to the input variable of the above communications instruction.

Input variable of the communications instruction	Specification	Value to pass to input variable	Meaning
RoutePath	Route path specification	02%IPaddress	"02" specifies the output from the NJ-series built-in EtherNet/IP port or the NX-series ibuilt-in EtherNet/IP port 1. The IP address specifies the IP address of the S8VK-X.
TimeOut	Timeout time specification	UINT#20	Timeout time is specified. The integer "20" specifies 2.0 s as the timeout time. It is 0.1s unit.
ServiceCode	Service codes	BYTE#16#0E	0E hex specifies "Service_Attribute_Single" as a service code which reads the value of the specified attribute.

Input variable of the communications instruction	Specification	Value to pass to input variable	Meaning
RqPath	Request path specification	Specified by user variable indicating the Request path	<p>Specify a user-defined variable.</p> <p>Use the data type "_sREQUEST_PATH" corresponding to the input variable "RqPath". You can use any variable name.</p> <p>Specify the following.</p> <p>Class ID, Instance ID, Attribute ID</p> <p>Example) Deterioration degree (current value):</p> <p>Specify the following.</p> <ul style="list-style-type: none"> • ClassID: = 372 hex (meaning "Monitor Object of the S8VK-X") • InstanceID: = 01 hex (fixed) • IsAttributeID: = TRUE (meaning to use an attribute ID) • AttributeID: = 65 hex (meaning Output voltage measured)
ServiceDat	Data to send	Not used (dummy variable)	Since the service code is "read", specify a dummy variable.
Size	Number of elements to send	UINT#0	Since the service code is "read", specify integer 0 (fixed).
RespServiceDat	Response data specification	Specified by user variable r variable to receive response data	<p>Specify a user-defined variable.</p> <p>Use the data type "ARRAY [0..10] OF BYTE" corresponding to the input/output variable "RespServiceDat". You can use any variable name.</p>

4

Monitoring and Setting with the Modbus TCP

This section describes how to monitor and configure the S8VK-X using the Modbus TCP.

4

4-1 Overview	4-2
4-2 Function Codes	4-3
4-2-1 Function Code List	4-3
4-2-2 03 hex: Reading of multiple registers	4-3
4-2-3 06 hex: Operation command (Resets the peak hold current)	4-5
4-2-4 10 hex: Writing of multiple registers	4-6
4-2-5 Exception Code List	4-7
4-3 Register Address Lists	4-8
4-3-1 Measurement/calculation data and Self-diagnostic information	4-8
4-3-2 Product Information and Communications Setting Data	4-9

4-1 Overview

This section provides an overview of how to monitor the S8VK-X using the Modbus TCP.

ModbusTCP is a communications protocol that uses TCP/IP to communicate with host devices such as PLCs.

This communications protocol allows host devices with a TCP/IP socket interface to read and write the internal data of the S8VK-X.

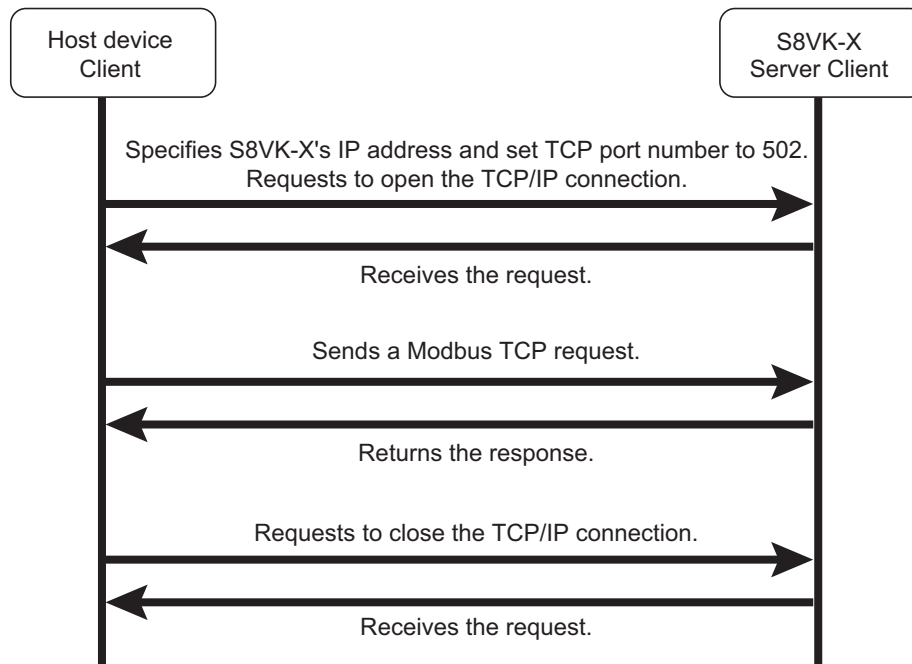
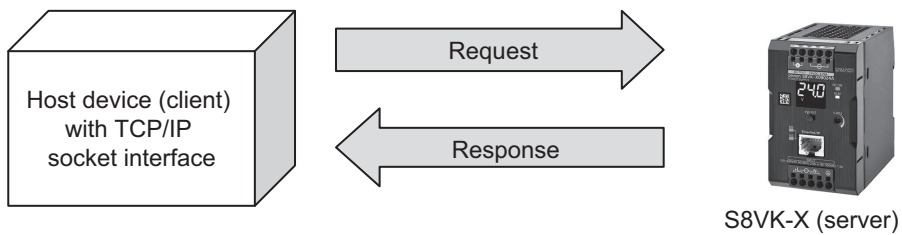

Note The socket is an interface for using TCP directly from the user program.

The host device specifies the IP address of S8VK-X and TCP port number of 502 (01F6 hex) and opens the socket in Active. After that, it sends Modbus TCP request and reads and writes the internal data of the S8VK-X.

In addition, Modbus TCP can be connected to up to two clients simultaneously.

4-2 Function Codes

This section describes function codes that can be used with Modbus TCP.

4-2-1 Function Code List

The function codes that can be used are as follows.

Function code	Function name	Usages
03 hex	Reading of multiple registers	Used to read output voltage, IP address, etc.
06 hex	Operation command	Used to reset the peak hold current.
10 hex	Writing of multiple registers	Used to set the IP address, etc.

4-2-2 03 hex: Reading of multiple registers

This function can read the contents of multiple registers starting from the specified address.

Frame configurations

The frame configurations of ModbusTCP are as follows.

● Request

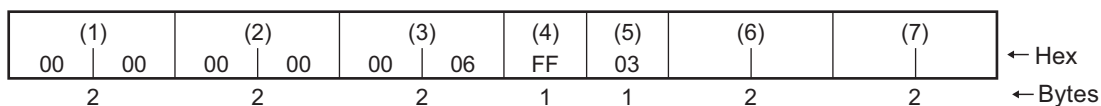

- (1): Transaction ID : Specify any value. For example, 0000 hex is used in this explanation.
- (2): Protocol ID : Specify 0000 hex.
- (3): Number of bytes transferred : Specify the total number of bytes of (4) and the successor. In the above case, it is from (4) to (7), so it is 0006 hex.
- (4): Unit ID : Specify FF hex.
- (5): Function code : Specify 03 hex (Reading of multiple registers).
- (6): Start address : Specify the address to start reading.
Refer to 4-3 *Register Address Lists* on page 4-8.
- (7): Number of words to read : Specify the number of words of the register to be read. The maximum value is 32 (0020 hex).

● Normal response

(1) 00 00	(2) 00 00	(3) 00	(4) FF	(5) 03	(8) 	(9) 	---	(9)
2	2	2	1	1	1	2		2

● Error response

(1) 00 00	(2) 00 00	(3) 00 03	(4) FF	(5) 83	(10)
2	2	2	1	1	1

- (3): Number of bytes transferred : The total number of bytes of (4) and the successor is set.
- (8): Byte count : The total number of bytes of (9) is set.
- (9): Register contents : Register contents from the start address to the number of read words are set.
- (10): Exception code : Error information is set. Refer to 4-2-5 Exception Code List on page 4-7.

Note 1. The elements shaded in the above figures are set to the value specified in the request.
 2. The function code of (5) at error response is 83 hex.

Example: Read all the Measurement/Calculation Data and Self-diagnostic Information

● Request

(1) 00 00	(2) 00 00	(3) 00 06	(4) FF	(5) 03	(6) 00 00	(7) 00 0A
----------------	----------------	----------------	-----------	-----------	----------------	----------------

- (6): Start address : Specify the address of the S8VK-X status.
- (7): Number of words to read : The total number of the measurement/calculation data and self-diagnostic information is 10 words (20 bytes), so specify 000A hex

● Normal response

(1) 00 00	(2) 00 00	(3) 00 17	(4) FF	(5) 03	(8) 14	S8VK-X status	---	Continuous run time
----------------	----------------	----------------	-----------	-----------	-----------	------------------	-----	------------------------

- (3): Number of bytes transferred : The total number of bytes of (4) and the successor are 23, so 0017 hex is set.
- (8): Byte count : The measurement/calculation data and self-diagnostic information is 20 bytes in total, so 14hex is set.

4-2-3 06 hex: Operation command (Resets the peak hold current)

This function resets the peak hold current.

Frame configurations

The frame configurations of ModbusTCP are as follows.

● Request

(1) 00 00	(2) 00 00	(3) 00 06	(4) FF	(5) 06	(6) 10 00	(7) 00 01	← Hex
2	2	2	1	1	2	2	← Bytes

- (1): Transaction ID : Specify any value. For example, 0000 hex is used in this explanation.
- (2): Protocol ID : Specify 0000 hex.
- (3): Number of bytes transferred : Specify the total number of bytes of (4) and the successor. In the above case, it is from (4) to (7), so it is 0006 hex.
- (4): Unit ID : Specify FF hex.
- (5): Function code : Specify 06 hex (Operation command).
- (6): Start address : Specify 1000 hex (Resets the peak hold current).
- (7): Number of words to read : Specify 0001 hex (Reset).

● Normal response

It is the same as the request.

● Error response

(1) 00 00	(2) 00 00	(3) 00 03	(4) FF	(5) 86	(10)
2	2	2	1	1	1

- (3): Number of bytes transferred : The total number of bytes of (4) and the successor is set.
- (5): Function code : 86 hex is set.
- (10): Exception code : The error information is set. Refer to 4-2-5 *Exception Code List* on page 4-7.

Note The elements shaded in the above figures are set to the value specified in the request.

4-2-4 10 hex: Writing of multiple registers

This function can write data to multiple registers with the specified address as the start address.

Frame configurations

The frame configurations of ModbusTCP are as follows.

● Request

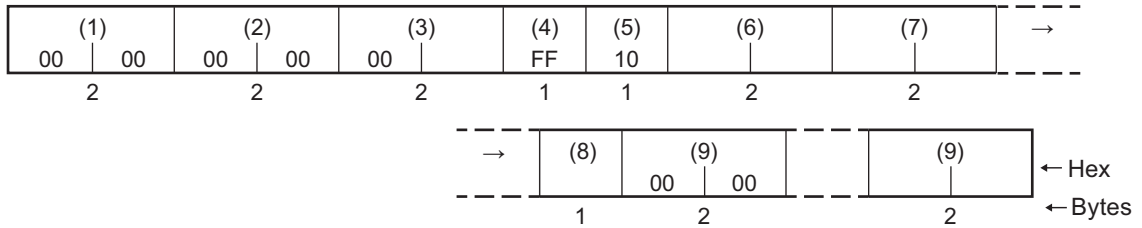

- (1): Transaction ID : Specify any value. For example, 0000 hex is used in this explanation.
- (2): Protocol ID : Specify 0000 hex.
- (3): Number of bytes transferred : Specify the total number of bytes of (4) and the successor.
- (4): Unit ID : Specify FF hex.
- (5): Function code : 10 hex (Writing of multiple registers) is specified.
- (6): Start address : Specify the address to start writing. Refer to 4-3 Register Address Lists on page 4-8.
- (7): Number of words to read : Specify the number of words of the register to be write. The maximum value is 8 (0008 hex).
- (8): Byte count : Specify the total number of bytes of (9).
- (9): Data : Register contents from the start address to the number of write words are set.

● Normal response

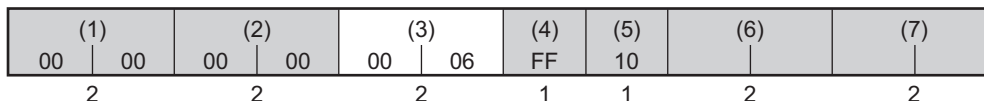

● Error response

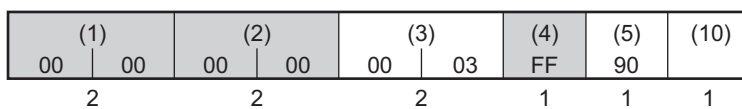

- (3): Number of bytes transferred : The total number of bytes after (4) is set.
- (10): Exception code : Error information is set. Refer to 4-2-5 Exception Code List on page 4-7.

Note 1. The elements shaded in the above figures are set to the value specified in the request.

2. The function code of (5) at error response is 90 hex.

Example: Change IP Address

● Request

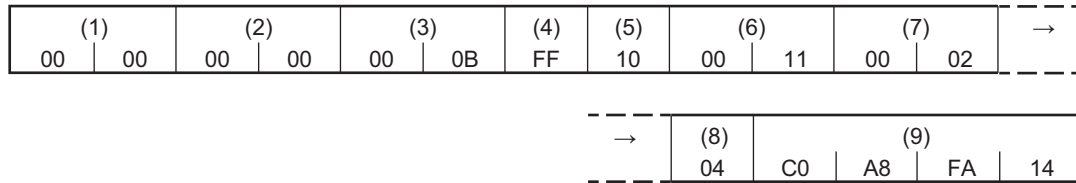

- (1): Transaction ID : Specify any value. For example, 0000 hex is used in this explanation.
- (2): Protocol ID : Specify 0000 hex.
- (3): Number of bytes transferred : The total number of bytes of (4) and the successor are 11, so specify 000B hex.
- (4): Unit ID : Specify FF hex.
- (5): Function code : 10 hex (Writing of multiple registers) is specified.
- (6): Start address : Specify the register address of the IP address.
- (7): Number of words to read : The IP address is 2 words (4 bytes), so specify 0002 hex.
- (8): Byte count : The total number of bytes of (9) is 4 bytes, so specify 004 hex.
- (9): Data : Specify 192.168.250.20 (C 0 A 8 FA 14 Hex) as the IP address.

● Normal response

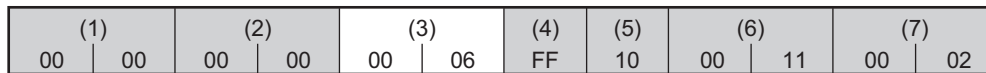

- (3): Number of bytes transferred : The total number of bytes of (4) and the successor are 6 bytes, so 0006 hex is set.

Note The elements shaded in the above figures are set to the value specified in the request.

4-2-5 Exception Code List

The following is the exception codes when an error response occurs. Confirm this content and review the request.

Exception code	Types of error	Description
01 hex	Illegal function codes	Unsupported function code is specified.
02 hex	Illegal data address	One or more addresses that can not be read or written are included.
03 hex	Illegal data value	The parameter value is invalid.
04 hex	Failure in associated device	It is in a state where normal value can not be returned.
06 hex	Busy	It can not be processed within the time. Wait a while and send the request again.

4-3 Register Address Lists

Registers that can be read and written using ModbusTCP are as follows.

4-3-1 Measurement/calculation data and Self-diagnostic information

Address	Parameter name	Data range	Meaning of the value	Number of bytes	R/W ^{*1}
0000 hex	S8VK-X status	0000 to 000F hex	Status of S8VK-X ^{*2}	2	R
0001 hex	Output voltage measured	0000 to 2706 hex (Decimal 0 to 9990)	0.00 to 99.90 V (0.10 V increments) ^{*3}	2	R
0002 hex	Output current measured	0000 to 2706 hex (Decimal 0 to 9990)	0.00 to 99.90 A (0.10 A increments) ^{*3}	2	R
0003 hex	Peak hold current measured	0000 to 2706 hex (Decimal 0 to 9990)	0.00 to 99.90 A (0.10 A increments) ^{*3}	2	R
0004 hex	Years until replacement	0000 to 5DC0 hex (Decimal 0 to 1500)	0 to 150.0 years (0.1 year increments)	2	R
0005 hex	Percentage until replacement	0000 to 3E8 hex (Decimal 0 to 1000)	0.0 to 100.0% (0.1% increments)	2	R
0006 hex	Total run time	0000 to 40290 hex (Decimal 0 to 262800)	0 to 262,800 hours (1 hour increments)	4	R
0008 hex	Continuous run time	0000 to F099C0 hex (Decimal 0 to 15768000)	0 to 15,768,000 minutes (1 hour increments)	4	R

*1. R: Read using Reading of multiple registers (03 hex).
W: Write using Writing of multiple registers (10 hex).

*2. The contents of the S8VK-X status are as follows.

Bit position	Status	Bit contents	
		0	1
0	Memory error	Not occurred	Occurrence
1	Product overheat abnormality	Not occurred	Occurrence
2	Current measurement error	Not occurred	Occurrence
3	Voltage measurement error	Not occurred	Occurrence
4	Overheating alarm	Not occurred	Occurrence
5	Reserved	-	-
6	Reserved	-	-
7	Reserved	-	-
8	Years until the replacement reached FUL	Other than FUL	FUL
9	Years until the replacement reached HLF	Other than HLF	HLF
10	Reserved	-	-
11	Reserved	-	-
12	Reserved	-	-
13	Reserved	-	-
14	Reserved	-	-
15	Reserved	-	-

*3. · The maximum value depends on the model type.
· The least significant digit of the value regarded as a decimal number is fixed to 0.

4-3-2 Product Information and Communications Setting Data

Address	Data name	Data Range	Number of bytes	R/W *1
000A hex	Vendor ID	Always 002F hex.	2	R
000B hex	Device type	Always 0302 hex.	2	R
000C hex	Product code	*2	2	R
000D hex	Device major revision	*3	2	R
000E hex	Device minor revision	*3	2	R
000F hex	Serial number	00000000 to FFFFFFFF hex	4	R
0011 hex	IP address	*4	4	R/W
0013 hex	Subnet mask	*4	4	R/W
0015 hex	Default gateway	*4	4	R/W
0017 hex	IP address setting method	00000000 hex: Static IP address 00000001 hex: BOOTP Always	4	R/W
0019 hex	MAC address	000000000000 to FFFFFFFFFFFF hex	6	R
001C hex	Product name	*5	32	R

*1. R: Read using Reading of multiple registers (03 hex).
W: Write using Writing of multiple registers (10 hex).

*2. The contents of the product codes are as follows.

Product Code	Model
068F hex	S8VK-X09024A-EIP
0690 hex	S8VK-X12024A-EIP
0691 hex	S8VK-X24024A-EIP
0692 hex	S8VK-X48024A-EIP
0693 hex	S8VK-X03005-EIP
0694 hex	S8VK-X06012-EIP
0695 hex	S8VK-X06024-EIP
0696 hex	S8VK-X09024-EIP
0697 hex	S8VK-X12024-EIP
0698 hex	S8VK-X24024-EIP
0699 hex	S8VK-X48024-EIP

*3. The device revision is as follows.

Example: In the case of version 1.23

Major: 0001 hex

Minor: 0023 hex

*4. IP address, subnet mask, default gateway are as follows.

Example: C0 A8 FA 14 hex (192.168.250.20)

*5. Product name is in ASCII notation.

Example: 53 38 56 4B ... hex (S8VK ...)

OMRON Corporation Industrial Automation Company

Kyoto, JAPAN

Contact : www.ia.omron.com

Regional Headquarters

OMRON EUROPE B.V.

Wegalaan 67-69, 2132 JD Hoofddorp

The Netherlands

Tel: (31) 2356-81-300 Fax: (31) 2356-81-388

OMRON ASIA PACIFIC PTE. LTD.

438B Alexandra Road, #08-01/02 Alexandra

Technopark, Singapore 119968

Tel: (65) 6835-3011 Fax: (65) 6835-2711

OMRON ELECTRONICS LLC

2895 Greenspoint Parkway, Suite 200

Hoffman Estates, IL 60169 U.S.A.

Tel: (1) 847-843-7900 Fax: (1) 847-843-7787

OMRON (CHINA) CO., LTD.

Room 2211, Bank of China Tower,

200 Yin Cheng Zhong Road,

PuDong New Area, Shanghai, 200120, China

Tel: (86) 21-5037-2222 Fax: (86) 21-5037-2200

Authorized Distributor:

©OMRON Corporation 2017-2022 All Rights Reserved.
In the interest of product improvement,
specifications are subject to change without notice.

Cat. No. T213-E1-06

0922